

FELTON BRUSHES

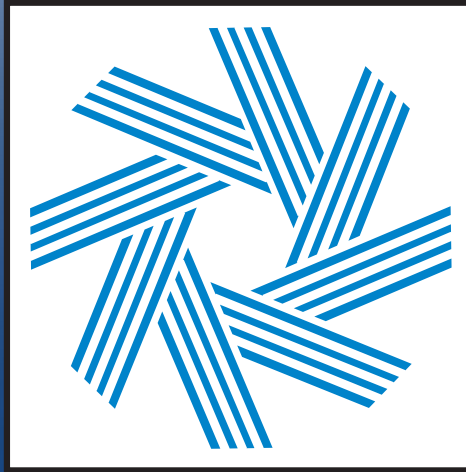

MANUFACTURING
SINCE 1933

FeltonBrushes.com



Quality & Safety - Made in Canada





2

Introduction

3

Knotted Wire Wheel

Stringer Bead, Joint and Crack Cleaning, Standard Twist, Heavy Duty, and Descaling.

3

Crimped Wire Wheels

Major Wire Wheels, Narrow Supreme Wire Wheels, Utility Wheels, and Key Deburring Brush.

7

Copper Centre Wire Wheels

8

Vulcanized Wire Wheel

9

Cup Brush Knotted Wire

Single Row, Single Row with Ring, Double Row, and Saucer Cup.

10

Cup Brush Crimped Wire

10

End Brush Circular Crimped Wire Wheel

<p>Knotted Wire End Brushes</p>	<p>11</p>	
<p>Crimped Wire End Brushes</p>	<p>11</p>	
<p>Scratch Brushes</p>	<p>12</p>	
<p>Twisted Brushes Tube Brushes, Double Stem, Condenser Tube, Flue Brushes, Metal-Free Tube Brushes, Valve Guide, and Cleaning Brushes.</p>	<p>13</p>	
<p>Maintenance Brushes Acid Brushes, Bannister Brush, Butcher Block, Deck Scrub, Dope Brush, Driveway Applicator, File Cleaning, Fitting Brushes, Masonary/Kalsomine, Tire Cleaning, Parts Cleaning, Platers Brushes, Radiator Brush, Roofer Brushes, Scrub Brushes, Spoke Brush, Utility, Tire Cleaning, Window Brushes.</p>	<p>16</p>	
<p>Brooms & Accessories</p>	<p>22</p>	
<p>Artist Brushes</p>	<p>24</p>	
<p>Custom Specification Sheets Major Wheels, Spiral Wound, Strip Brush, Twisted.</p>	<p>26</p>	



Welcome to the New Catalogue

Felton Brushes is proud to manufacture in Canada. We rely on U.S.A. and Canadian supplied top grade wire to stay honest in making a safe and high quality product. We invest in the best brush making technology from Europe to deliver the lowest cost solutions. Our dedication to R&D have enabled us to launch our new solid hub non-sparking brush. This innovative new brush design is only one example of what we are producing. We have also invested in new rapid prototyping technology featuring 3D printing technologies that enable us to turn around new products to help our customers clean and deburr in hours, not weeks.

We are devoted to our employees, our suppliers, and ultimately to you our customers in the pursuit of prosperity.

Thank you for picking up this catalogue. We hope that we can be of service to you.

Tony Ponikvar
CEO – Felton Brushes Limited
Cell: 905.520.3400
Work: 905.522.3811 Ext. 233
Email: tony@feltonbrushes.com

Quality & safety — Made in Canada since 1933

Felton's 187 - A Leader In Its Class

Felton's 187 is made in Canada using high quality wire and top of the line machinery. Currently used in the oil and pipeline industry, this brush has been tested and proven to be safer and have a longer life than leading competitors. Call Felton today to try this brush.



STUDY RESULTS

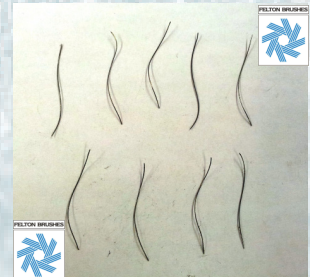

Felton - 9 Wires Flew



Leading Competitor - 133 Wires Flew

Solid Hub Construction

- Faster Cleaning.
- Super smooth running.
- 50% reduction in cycle time.
- Less pressure needed - less fatigue for operator.
- More complete cleaning.
- Up to two times better brush life.
- Less wire breakage.



AL5-B

Brass Version
is 100%
Non-sparking.

Dia.	Brush Face	Arbor	Wire	No. of Knots	Trim	RPM	Box Qty.	Brass
4-7/8"	3/16"	5/8"-11	.020	50	1-1/8"	18000	5	AL5B
5-7/8"	3/16"	5/8"-11	.020	56	1-1/8"	15000	5	AL6B

Felton Premium Original

- Narrow face for confined and hard to reach contact areas.
- Low Flex, high impact aggressive brush action perfect for expansion joints and filler welds.
- For root and hot pass weld cleaning.



Private or Co-Labeling
available on larger
orders

815TSS

Dia.	Brush Face	Arbor	Wire	No. of Knots	Trim	RPM	Box Qty.	Steel	Stainless	Brass
4"	3/16"	5/8"-11	.020	32	3/4"	20000	5	814T	814TSS	814TB *
4-7/8"	3/16"	5/8"-11	.020	48	1-1/8"	12500	5	815T	815TSS	815TB *
5-7/8"	3/16"	5/8"-11	.020	56	1-1/8"	12500	5	816T	816TSS	816TB *
6-1/2"	3/16"	5/8"-11	.020	56	1-1/4"	12000	5	817T	817TSS*	817TB *
4-1/2"	3/16"	5/8"-11	.020	42	7/8"	12500	5	B454*	B464*	-
4-7/8"	3/16"	5/8"-11	.020	42	1"	12500	5	B504*	B514*	-
5-7/8"	3/16"	5-8"-11	.023	48	1-1/4"	12500	5	B605*	B614*	-
	1/2"	5/8"-11	.023	24	1-1/4"	12500	5	B606*	B616*	-

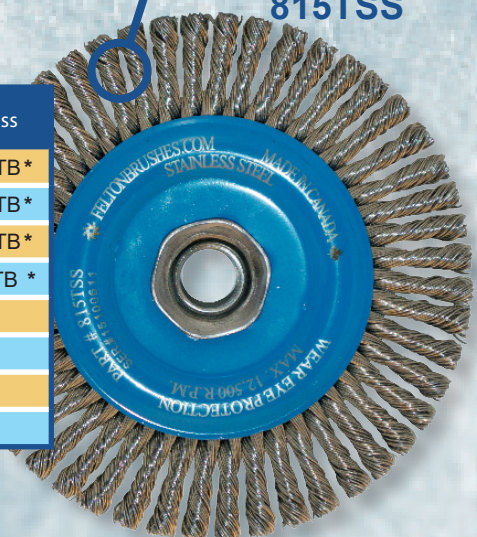

* non-stock item (Please call customer service for any special order requests)

** Minimum order 100 units.



K606



- Heavy burr, coating, rust, scale and weld spatter removal.
- Aggressive high impact brushing action.
- Surface conditioning.
- Rugged Knot Type construction.
- Severe applications.

Dia.	Brush Face	Arbor	Wire	No. of Knots	Trim	RPM	Box Qty.	Steel	Stainless
3"	3/8"	3/8-1/2"	.014	18	5/8"	25000	5	K303	-
4"	1/2"	1/2"	.014	20	7/8"	20000	5	K403	-
4"	1/2"	5/8"-11	.020	20	7/8"	20000	5	K404	K414**
5"	1/2"	5/8"-11	.020	20	7/8"	15000	5	K504	K514**
6"	1/2"	5/8"	.014	28	1-1/4"	9000	5	K603	K613**
6"	1/2"	5/8"-11	.023	28	1-1/4"	9000	5	K606	-
8"	5/8"	5/8"*	.014	40	1-1/4"	8500	5	K803	K813**
12"	3/4"	1-1/4" KWY	.014	52	2-5/8"	3600	5	K913**	-

* Different arbour holes available.

** non-stock item, made to order, call for lead time.

S404



Saucer Cup Knotted Wire Wheel

- A more aggressive brushing action than the crimped style wheel.
- Ideal for the removal of burrs, welding scale, corrosion, paint etc.
- Reach into corners and inside edges for a more effective clean.

Dia.	Arbor	Wire	Trim	Face Width	RPM	Steel	Stainless
4"	5/8-11 UNC	.020	3/4"	1/2	20000	S404	S414*
5"				1/2		S504	S514*

L137

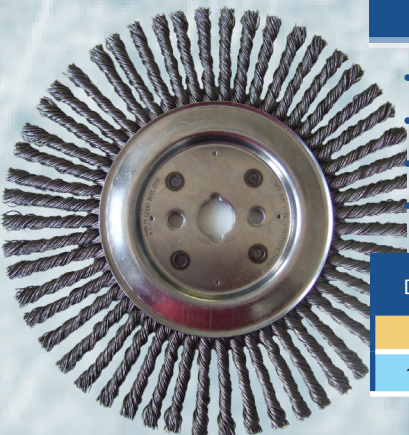

Joint/Crack Cleaning Wire Wheel

- Cleaning cracks in concrete and asphalt.
- Preparing expansion joints before filling and sealing.
- Can be used on walk-behind machines
- Custom specs available

Dia.	Brush Face	Arbor	Wire	No. of Knots	Trim	RPM	Box Qty.	Steel
8"	5/16"	5/8"	.023	40	1-5/8"	6000	5	L806*
12"	3/4"	3/8"	.035	52	3-1/16"	5000	5	L137*

Heavy Duty Wire Descaling Wheel



- Four Knot sections combined into 1 brush.
- Used on descaling equipment.
- KK124 ideal for Axle cleaning.
- KK104 ideal for Hub City pipe cleaning machines.

Dia.	Brush Face	Arbor	Wire	No. of Knots	Trim	RPM	Box Qty.	Steel
10"	2"	2"	.020	208	1-3/4"	4500	1	KK104
12"	2"	2"	.020	208	2-3/4"	3600	1	KK124



KK124

Heavy Duty 2 Row Knot Wire Wheel

- Covers more surface area in a single pass.
- Two knot sections combined into 1 brush.
- Ideal for external pipe cleaning..
- Stainless steel available upon request.

Dia.	Brush Face	Arbor	Wire	No. of Knots	Trim	RPM	Box Qty.	Steel
6"	1"	1-1/8"	.020	60	1-3/8"	6000	1	KK602 *
8"	1-1/8"	2"	.023	76	1-5/8"	6000	1	KK803 *

* Non-stock item, all sizes & shapes are available, call for quote and delivery times.



KK803

Narrow Supreme Wire Wheel

- Narrower and more flexible.
- Deburring & finishing job.
- Singles or Stacked and stamped to desired arbor hole.
- Minimum custom order is 10 - 50.

Dia.	Brush Face	Arbor	Wire	Trim	RPM	Box Qty.	Steel
4"	1/2"	1/2"	.012	7/8"	12500	5	N402
6"	1/2"	1/2"	.120	1-1/4"	12500	5	N603
8"	1/2"	1/2"	.014	1-1/2"	6000	5	N803
9"	1/2"	1/2"	.014	2"	6000	5	N903

Custom arbor holes available, call for quote and delivery times.



N603

Special Orders

You may order any custom brush by providing us information filled out below table.

- Specified drawing.
- Contact the Engineering department at Felton Brushes.
- We can accommodate your individual applications.
- Application to be used.

N602-3





- Top grade wire for long service life & reduced wire breakage.
- Efficient, light cleaning applications.
- Good for edge blending and surface preparation.

Dia.	Brush Face	Arbor	Wire	Trim	RPM	Std. Pkg.	Steel (No Adapter)	Stainless (No Adapter)	Adapter Included (1/2" & 5/8")
4	7/8"	1-1/8"	.014	1.0"	6000	1	M12430*	-	-
6"	7/8"	2"	.012	1.0"	6000	1	M12633	M12633SS	-
			.014	1.0"	6000	1	M12630	M12630SS	M12630-AD
7"	7/8"	2"	.012	1.0	4500	1	M12733	M12733SS	-
			.014	1-1/4"	4500	1	M12730	-	-
8"	7/8"	2"	.012	1-3/8"	4500	1	M12833	-	-
			.014	1-3/8"	4500	1	M12830	M12830SS*	M12830-AD
10"	1-1/4"	2"	.014	2-1/8"	3500	1	M131030	M131030SS*	-
12"	2"	2"	.014	3-1/8"	3500	1	M141230*	-	-

M12430CUST



Special Orders

- Cleaning and buffing coated steel cables
- Other custom brushes and specs are available

Dia.	Brush Face	Arbor	Wire	RPM	Std. Pkg.	Steel
4"	1-1/4"	1/2"	.014	6000	1	M12430CUST

* Please call customer service for special order requests.

ADAPTERS Adapters

- For all bench wheels with 2" arbor holes.



For Brush Arbor Hole Size	Adapter Arbor Hole Size	Adapter #
2"	1/2"	AD212
	5/8"	AD258
	3/4"	AD234
	7/8"	AD278
	1"	AD201
	1-1/4"	AD2114
	1-1/2"	AD2112



- Filled with high quality steel wire.
- Band saw blade cleaning brush.
- Small diameter brushes used for deburring, stripping wire, removing rust, scale, corrosion or blending tool marks.
- Can be used single or in multiples.
- Also available with Tampico and Nylon.

ENCAPSULATED BRUSHES

- Safe, outperform and outlast.
- Gradually exposing a consistent amount of short trim for maximum aggression and longer life.
- For deburring in tight spots.
- Wire and encapsulation material wears into a 'dust' for fine particle filter applications.



CC207

Encapsulated wire has no wire breakage and a lifespan 10x longer.



CC310ENCAP

Dia.	Brush Face	Arbor	Wire	RPM	Std. Pkg.	Steel	Encapsulated
1-1/2"	1/4"	3/8"	.005	20000	10	CC110	-
2"	3/8"	1/2-3/8"	.005	20000	10	CC203	CC203ENCAP
			.012			CC207	-
2-1/2"	1/2"	3/8"	.012	20000	10	CC251	-
3"	5/8"	1/2"	.008	20000	10	CC307	CC307ENCAP
	5/8"	1/2-3/8"	.014	20000	10	CC310	CC310ENCAP
4"	5/8"	1/2"	.012	20000	10	CC405	-

Utility Wire Brushes

Key Deburring Brush

- Filled with high quality steel wire.
- Tire retreading brush.
- Used in many rubber scuffing applications.
- 30027 - Great for deburring keys.
- Used in industry leading key machines.



U314



30027

Dia.	Brush Face	Arbor	Wire	RPM	Box Qty.	Steel	Stainless	Silicone Carbide
3"	3/16"	3/8"	.020	5000	5	U314	-	-
	3/16"	1/2"				U324	-	-
3"	3/8"	1/2"	120 grit	5000	1	-	-	30027



ADVANTAGES OF POLYURETHANE ENCAPSULATED WIRE WHEELS

Felton Brushes provides customers with excellent encapsulated wire wheels for use in heavy duty deburring applications.

The controlled face width set by the brush mould allows for tight area deburring .

Safe bonded operation.

Wire bonded in special Polyurethane Plastic firmly provides face width control, and a timely exposure of evenly displaced wire tips for aggressive removal rates and out performance

NEW FELTON VULCANIZED SERIES ADVANTAGES

Felton Brushes has launched a new line of plastic set brushes which do not degrade over time

#1 New product for Pipeline Welding in Europe

Injection moulding allows for varying brush densities and wire diameters to be encapsulated

Best for removing rust, scale, and roughing surface preparation

- Long lasting applications.
- Suitable for high temperature as it does not leave any residue on brush surface.
- Safe construction prevents the risk of broken wire.
- Ideal for welded surface.
- Does not degrade over time.

Dia.	Brush Face	Arbor	Fill	Trim	Strand count	RPM	Steel
7"	1/4"	7/8"	.016 Wire	1-1/2"	2000	9000	V707*
					2400		V704*

* Available in 5" and other sizes
* Non-stock item, call for quote and delivery times.

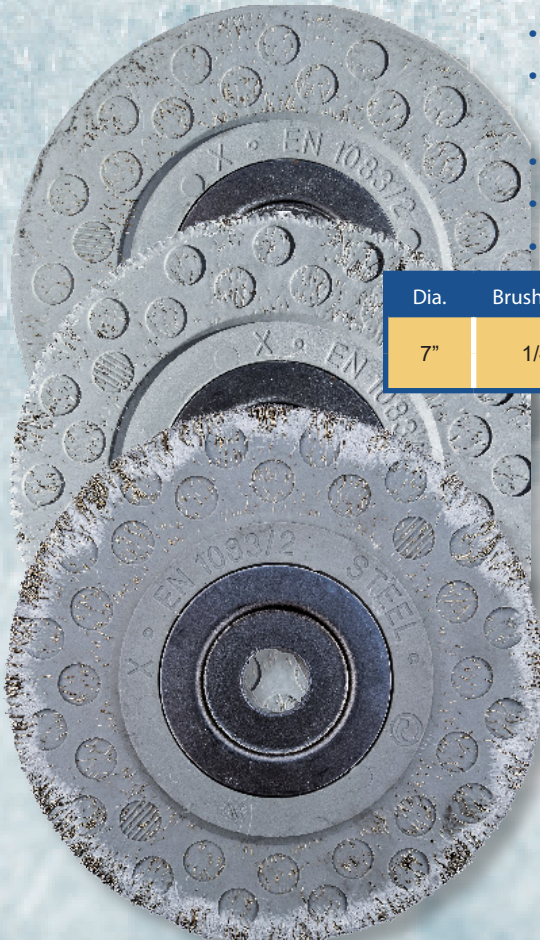

- Double Row
- Used for the most severe applications.
- Very aggressive.

CD554

Dia.	Flared Dia.	Arbor	Wire	Trim	RPM	Pkg.	Steel
5-1/2"	6"	5/8-11 UNC	.035	1-3/8"	6600	1	CD553
5-1/2"	6"		.020				CD554



Cup Brush Knotted Wire Single Row

- Strong and effective for heavy duty cleaning.
- Top quality steel made in USA.
- Remove weld scale, rust, old paint, and corrosion.
- Designed for the most rugged job.
- Small diameter brushes great for cleaning welds.

C204

Dia.	Flared Dia.	Arbor	Wire	Trim	RPM	Box Qty.	Steel	Stainless
2-3/4"	3"	5/8"-11 UNC	.020	1.0"	14000	5	C204	C214
3-1/2"	3-3/4"	5/8"-11 UNC	.020	1.0"	12500	5	C354	C364
4"	4-1/4"	5/8"-11	.020	1	9000	1	C404	C414
5"	5-1/4"	5/8"-11 UNC	.020	1-3/8"	7000	1	C504	-
6"	6"	5/8"-11 UNC	.020	1-1/2"	6000		C604	-



Cup Brush Knotted Wire Single Row with Ring

- Ring provides a short aggressive trim length.
- Removal of ring provides more usable wire.
- The same benefits of regular Cup Brush. Knotted Single Row and more.
- Ring controls unnecessary flaring, and premature wire breakage.

C375

Dia.	Flared Dia.	Arbor	Wire	Knot Style	Trim	RPM	Box Qty.	Steel	Stainless
3"	3"	5/8-11 UNC	.020	Full	7/8"	11000	1	C375	C395
4"	4"		.020			9000		C475	C495
5"	5"		.020			7000		C575	C595





P203



- Top grade wire for long service life and reduced wire breakage.
- Removal of burrs, weld scale, corrosion, paint, etc.
- Softer impact and more flexible than knotted style.
- Good for edge blending and surface preparation.
- Efficient light cleaning of large surface areas.

Dia.	Flared Dia.	Arbor	Wire	Trim	RPM	Pkg.	Steel	Stainless
2-3/4"	3"	5/8"-11 UNC	.014	1.0"	14000	5	P203	P213
3-1/2"	3-3/4"	5/8"-11 UNC	.014	1.0"	12000	5	P350	P360
4"	4-1/2"	5/8"-11 UNC	.020	1-3/8"	9000	5	P404	P414
5"	5-1/2"	5/8"-11 UNC	.020	1-1/4"	9000	5	P504	P514
6"	6-1/2"	5/8"-11 UNC	.020	1-1/4"	9000	5	P604	P614

E367



Knotted Circular End Brush

- More aggressive brushing action than crimped style.
- Great for the removal of burrs, weld scale, corrosion, paint etc.
- Ideal for reaching into corners and inside edges.

Dia.	Arbor	Wire	Trim	RPM	Std. Pkg.	Steel	Stainless
3"	7/16"	.014	3/4"	25000	5	E367	E377
3-1/2"	7/16"	.014	1"	25000	5	E369	-

Crimped Circular End Brush Wire Wheel

E333

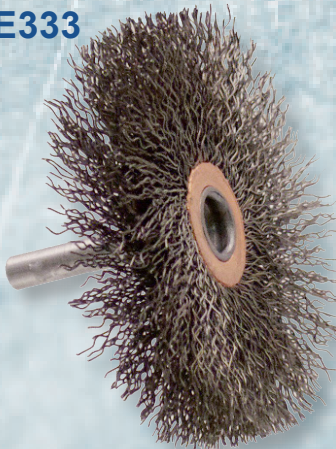

- Removal of burrs, weld scale, corrosion, paint etc.
- Softer impact and more flexible than knotted style.
- Efficient, light cleaning of small surface areas.
- Great for ID pipe cleaning and grooves.
- 1/4" shank.

Dia.	Brush Face	Wire	Trim	RPM	Std. Pkg.	Steel	Stainless	Brass
1-1/2"	1/4"	.005	7/16"	20000	10	E300	-	-
		.014				E303	E313	E703
2"	3/8"	.008	1/2"			E321	-	-
		.012				E322	-	-
		.014				E323	E343	-
3"	5/8"	.008	1"			E331	E351	-
		.014				E333	E353	E733

Knotted Wire End Brush



- Ideal for flash, scale, rust, corrosion, and paint removal etc.
- Great tool to reach into holes and hard to reach areas.
- More aggressive brushing action than crimped style.
- High strength knotted wire for high impact brushing.

187



The worldwide leader in drill pipe thread cleaning applications.

Dia.	Arbor	Wire	Trim	Face Width	Steel	Stainless
1/2"	1"	.006	22000	10	E103	E113
3/4"	1"	.014	22000	10	E106	E116
		.020			E107	-
1"	1"	.012	25000	10	187	187SS
		.014			186	186SS
		.020			185	185SS

* Non-stock item, call for quote and delivery times.

Crimped Wire End Brush

- Ideal for flash, scale, rust, corrosion, and paint removal etc.
- Softer impact and more flexible than knotted style.
- Great for polishing, edge blending and surface preparation.
- Efficient, light cleaning of small, hard to reach areas.

E213



E223



Dia.	Trim	Wire	RPM	Std. Pkg.	Steel	Stainless	Brass
1/2"	7/8"	.006	20000	10	E200	E240	-
		.014			E203	E243	-
3/4"	7/8"	.005	20000	10	E210	E250	E910
		.014			E213	E253	E973
1"	7/8"	.005	20000	10	E220	E260	E970
		.014			E223	E263	-

Spring Brush

- Stem Mounted Coil Spring Brush.
- Flexible heavy cleaning action. Spring may be trimmed as brush wears.
- Ideal for cleaning deep cavities, tubing, and more.

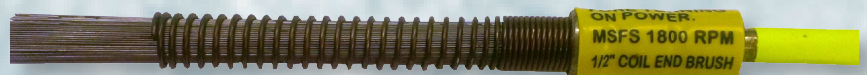

10133

Dia.	Overall Length	Shank Size	Fill	Std. Pkg.	Item #
3/8"	6-1/4"	1/4"	Steel	12	10133*
1/2"				12	10134*

* Non-stock item, call for quote and delivery times.



SB702

Shoe Handle Scratch Brush

- Heavy duty scraper for durability



Block Size	Brush Length	# of Rows	Trim Length	Wire	Std. Pkg.	Steel
11-3/8" x 1-1/2"	5-1/2"	4 x 13	1-1/8"	.014	10	SB702

Scratch Brushes

All FELTON Scratch Brushes are made of kiln-dried premium hardwood, with a smooth finish for extra comfort. They are more densely filled than the competition, with high carbon .012 diameter, oil tempered steel for long wear and efficient material removal.



1777



188SS



1777B

Block Size	Brush Length	# of Rows	Trim Length	Std. Pkg.	Steel	Stainless	Brass
14" x 5/16"	6"	3 x 19	1-1/8"	20	1777	1777SS	1777B
14" x 1-1/8"	6"	4 x 19	1-1/8"	20	188	188SS	188B

Curved Handle - Small Cleaning Brush



SB2088SS



SB2088PHB

- Ideal multi-application small wood handle cleaning brush.
- Available in solid wood and plastic handle.

Block Size	Brush Length	# of Rows	Trim Length	Std. Pkg.	Stainless	Brass	Nylon
7-3/4" x 7/16"	1-1/2"	3 x 7	1/2"	36	SB2088SS	SB2088B	SB2088N
7-1/4" x 7/16"	1-1/2"	3 x 7	1/2"	36	SB2088PHSS	SB2088PHB	SB2088PHN

1718SS



Shoe Handle Scratch Brushes

- Handles are made of hardwood providing a higher value for infrequent jobs.
- Ergonomically designed for vertical upright brushing action.
- Smooth finish for comfort and a hang up hole for easy storage.

Block Size	Brush Length	# of Rows	Trim Length	Std. Pkg.	Steel	Stainless	Brass
10" x 1-1/6"	5-1/4"	4 x 16	1-1/8"	20	1781	1781SS	1781B



Power Fitting Tube Brush

Dia.	Brush Area Length	WIRE			Steel
		Wire Size	Overall Length	Stem Dia.	
1/4"	1-1/2"	.005	4"	.08	T105
3/8"	2"	.005	4"		T109
1/2"	2"	.006	5"	.120	T110
5/8"	2-1/2"	.006	5"		T112
3/4"	2-1/2"	.006	5"	.150	T113
7/8"	3"	.010	5"		T216
1"	3"	.010	5-1/2"	.172	T217

T110



T313



Dia.	Brush Area Length	WIRE			Steel
		Wire Size	Overall Length	Stem Dia.	
1/4"	1"	.004	3-1/2"	.23	T305
5/16"	1"	.004			T306
1/2"	1"	.005			T310
5/8"	1"	.005			T312
3/4"	1"	.008			T313
1"	1"	.008			T315

Handheld Tube Brush

Dia.	Brush Area Length	Wire Size	Overall Length	Stem Dia.	WIRE		
					Steel	Stainless	Brass
1/8"	1"	.003	6"	.08	T501	-	T541
3/16"	1-1/2"	.005	7"		T503	-	T543
1/4"	1-1/2"	.003	7"		T505	T525	T544
5/16"	1-1/2"	.005	7"		T507	-	-
3/8"	2"	.005	8"	.120	T509	T529	T549
1/2"	2"	.005	8"		T510	-	T550
5/8"	2-1/2"	.005	9"	.150	T512	-	T552
3/4"	2-1/2"	.005	9"		T513	T533	T553
7/8"	3"	.012	10"	.172	T514	-	T554
1"	3"	.003	10"		T515	T535	T555
2"	3"	.003	10"		T520	-	-

T613

T535



Dia.	Brush Area Length	Wire Size	Overall Length	Stem Dia.	NYLON	
					Hair	Nylon
3/16"	2"	.010	7"	.08	-	T603
1/4"					T705	T605
3/8"		.014		.120	T709	T609
1/2"					T710	T610
5/8"		.010	.150	-	T612	
3/4"				T713	T613	
1"		.014	.172	T715	T615	
1-1/4"				-	T618	
2"	-			T619		

For Products without SKU, Please call Customer service and ask MOQ and Lead time.



F3334

Flue/Boiler Tube Brushes (Double Stem/Single Spiral)



Exact Brush Dia.	Flue/Tube Outside Dia.	Brush Area Length	Wire Size	Overall Length	Std. Pkg.	Carbon Steel
1"	1-1/4"	4"	.012	8"	4	F3114
1-1/4"	1-1/2"	4"	.012	8"	4	F3112
1-3/4"	2"	4"	.012	8"	4	F3200
2"	2-1/4"	4"	.012	8"	4	F3214
2-1/4"	2-1/2"	4"	.012	8"	4	F3212
2-1/2"	2-3/4"	4"	.012	8"	4	F3234
2-3/4"	3"	4"	.012	8"	4	F3300
3"	3-1/4"	4"	.012	8"	4	F3314
3-1/4"	3-1/2"	4"	.012	8"	4	F3312
3-1/2"	3-3/4"	4"	.012	8"	4	F3334
4"	4-1/4"	4"	.012	8"	4	F3414
4-1/4"	4-1/2"	4"	.012	8"	4	F3412
4-1/2"	4-3/4"	4"	.012	8"	4	F3434
5"	5-1/4"	4"	.012	8"	4	F3514
5-1/2"	5-3/4"	4"	.012	8"	4	F3534

For Products without SKU, Please call Customer service and ask MOQ and Lead time.

* The F3000 series is a more aggressive brush than the F2000 series double stem/ double spiral.

F2334

Flue/Boiler Tube Brushes (Double Stem/Double Spiral)



Round Tube Brush is ideal to use for threaded blinded holes, fully chucked.

Exact Brush Dia.	Flue/Tube Outside Dia.	Brush Area Length	Wire Size	Overall Length	Std. Pkg.	SKU
5/8"	7/8"	4"	.012	7-1/2"	4	F2078
1"	1-1/4"	4"	.012	7-1/2"	4	F2114
1-1/4"	1-1/2"	4"	.012	7-1/2"	4	F2112
1-3/4"	2"	4"	.012	7-1/2"	4	F2200
2"	2-1/4"	4"	.012	7-1/2"	4	F2214
2-1/4"	2-1/2"	4"	.012	7-1/2"	4	F2212
2-3/4"	3"	4"	.012	7-1/2"	4	F2300
3"	3-1/4"	4"	.012	7-1/2"	4	F2314
4-1/4"	4-1/2"	4"	.012	7-1/2"	4	F2412
5"	5-1/4"	4"	.012	7-1/2"	4	F2514
5-1/4"	5-1/2"	4"	.012	7-1/2"	4	F2512

Non-Metallic Tube Brushes

- High grade 100% FDA approved polypropylene, metal-free and chemical resistant
- Scratch free scrubbing
- Bristles fused to stem to minimize contamination and improve bristle hold

Dia.	Brush Area Length	Wire Size	Overall Length	WIRE			
				Flexible	Standard	Rigid	Double Leader
1/4"	1-1/2"	.008	12"	NMF121814	-	-	-
3/8"	2"			NMF121838	-	-	-
1/2"	2"			NMF1231612	-	-	NMD2431612
5/8"	2-1/2"			NMF121458	-	-	-
3/4"	2-1/2"			NMF121434	NMS123834	NMR121234	NMD2431634
7/8"	3"			NMF121478	NMS123878	-	-
1"	3"			NMF12141	NMS12381	NMR12121	NMD243161
1-1/4"				-	NMS1238114	NMR1212114	-
1-1/2"				-	NMS1238112	NMR1212112	-
1-3/4"				-	NMS1238134	NMR1212134	-
2"	3"			NMF1214114	NMS12382	NMR1212212	-
2-1/2"				-	NMS1238212	NMR12123	NMR12123

* Double Leader series is 24" handle length and .016" filament



NMS12834



NMF12814

Valve Guide Brush

- Deburring oil hole and valve bore, especially Automotive industry.

Dia.	Brush Area Length	Wire Size	Overall Length	Std. Pkg.	SKU
5/16"	1-5/8"	.010	36	1	T516
3/8"					T517

* Call a representative for customization



T517

Conroy Brush - Nylon

Dia.	Brush Area Length	Wire Size	Overall Length	Std. Pkg.	SKU
1-1/2"	4"	.014	30"	10	T1628



T1628

Fiberglass Rods



Dia.	Thread Size NPT	Overall Length	MOQ	Std. Pkg.	SKU
3/8"	1/4"	36"	6	1	3836
3/8"	1/4"	48"	6	1	3848
3/8"	1/4"	72"	6	1	3872





Acid Brushes - Tin Ferrule Style

SB747



Brush Width	Trim Length	Overall Length	Std. Pkg.	SKU	FILL MATERIAL
3/16"	3/4"	5-3/4"	144	SB747	Horse Hair
3/8"			144	SB748	
1/2"			144	SB749	
5/8"			144	SB750	

File Cleaning Brush

SB763



Brush Width	Trim Length	Overall Length	Std. Pkg.	SKU	FILL MATERIAL
1-1/2"	5"	10"	10	SB763	Card & Brush Combo
1-1/2"	5"	10"	10	SB727	Card ONLY

SB727



Tire Cleaning Brush

SB1265B



Brush Width	Trim Length	Overall Length	Std. Pkg.	SKU	FILL MATERIAL
2-1/2" x 3"	1/2"	9"	20	SB1265B	Brass Filaments
				SB1265SS	Stainless Steel Wires

Parts Cleaning Brush

T401T



Brush Width	Trim Length	Overall Length	Std. Pkg.	SKU	FILL MATERIAL
1"	2-3/4"	12-1/2"	20	T401T	TAMPICO FILL
				T401N	NYLON FILL

SB427

Pot Brush



Brush Width	Trim Length	Overall Length	Std. Pkg.	SKU	FILL MATERIAL
3" x 3"	2"	8"	12	SB427	TAMPICO
				SB430	PLASTIC

For Products without SKU, Please call Customer service and ask MOQ and Lead time.

Scrub Brush (Wood Block)

Brush Width	Trim Length	Overall Length	Std. Pkg.	SKU	FILL MATERIAL
2-1/2"	1-1/8"	9"	12	SB1343T	TAMPICO



SB1343T

Window Brush

- Made with flow-through water hole. Handles are not included.

Brush Width	Trim Length	Overall Length	Std. Pkg.	SKU	FILL MATERIAL
5"	2-1/2"	5"	5	SB865	White Tampico
5"	2-1/2"	5"	5	SB865BLU	Plastic



SB865

Truck Wash Brush

- Soft fill, durable, won't harm surface. Handles sold separately.

Brush Width	Trim Length	Overall Length	Std. Pkg.	SKU	FILL MATERIAL
2-1/2"	2-1/2"	9"	5	SB184BLU	Plastic
				SB184T	TAMPICO
				SB184FP	FLAGGABLE Plastic



SB184FP

Boat Brush

- Brushes for deck and hull cleaning.
- SB634 is a more aggressive brush for floors and hard to clean surface.
- SB635 is a flagged material which is gentler to delicate surfaces and glass.

Block Size	Trim Length	Filament	Std. Pkg.	SKU
6-3/4"	2"	.026	10	SB634
6-3/4"	2-1/2"	.013	10	SB635



SB635 SB634

Deck Scrub Brush

- Complete with rubber squeegee.
- Filled with extra Palmyra, Tampico or plastic.
- Handle sold separately

Brush Width	Trim Length	Overall Length	Std. Pkg.	SKU	FILL MATERIAL
2-1/2"	1-1/4"	11"	5	SB87T	TAMPICO



SB87T

For Products without SKU, Please call Customer service and ask MOQ and Lead time.



SB104



Straight Back/Butcher Block Brush

- Most aggressive scratch brushes made with flat steel wires.

Block Size	Brush Length	# of Rows	Trim Length	Fill Dia.	SKU	FILL MATERIAL
7-5/8 x 2-5/8	7	5 x 10	1-1/8	FLAT	SB104	Steel
WITH HANDLE						
9 x 4	8-1/2	8 x 12	1-1/8	FLAT	SB410	Steel

SB410



Straight Back (block) Scratch Brushes

- Designed to cover large areas with ease.

Block Size	Brush length	# of Rows	Trim Length	Fill Dia.	Std. Pkg.	Steel
7-1/4" x 2-1/2"	7"	6 x 19	1-1/8"	.014	10	1780

Bannister Brush

SB7



Brush Width	Trim Length	Overall Length	Std. Pkg.	SKU	FILL MATERIAL
1-1/2"	2-1/2"	8-1/2"	5	SB7	Hair Mix
				SB970	Plastic Fill

Roofers Brush

- Filled with Tampico fiber. Handles are not included.



SB5435

Brush Width	Trim Length	Overall Length	Std. Pkg.	MOQ	SKU	FILL MATERIAL
2"	2-3/4"	2-1/8"	5	10	SB5431	White Tampico fill
		6"		20	SB5433	

SB2460



Masonry/Kalsomine - White Wash Brush

- Filled with white Tampico fiber, For applying for coating, Wooden 6" handle.

Brush Width	Trim Length	Overall Length	Std. Pkg.	SKU	FILL MATERIAL
1"	3"	7"	10	SB2460	White Tampico (3 rows)

Platers Brushes

- Used by platers and metal finishers for hand brushing jobs in plating process, and fine metal work.

SB182

Y129



Brush Width	Trim Length	Overall Length	Std. Pkg.	SKU	FILL MATERIAL
1/2"	1"	13"	12	SB182	Bronze
5/8"	1"	8"	12	Y129	Horse Hair

Inside Fitting Brush

- An answer to clean fittings.
- High carbon crimped steel bristles will cut faster and last longer than small brushes.

Brush Length	Overall Length	Wire	SKU
1"	6-3/8"	1/4"	961070
		3/8"	961150
		1/2"	961210
		5/8"	961270
		3/4"	961330
		7/8"	961390
		1"	961450



Metal Chip Brush

- Great for cleaning out small, hard-to-reach areas hot to the touch.
- Great for removing chips from indexable tooling, cutterheads.

Brush Width	Trim Length	Overall Length	Std. Pkg.	SKU	FILL MATERIAL
1-1/2"	1-1/2"	5-1/2"	12	10018	Steel
				20018	Stainless Steel



10018

Spoke Brush - Single

Brush Width	Overall Length	Std. Pkg.	SKU	FILL MATERIAL
2-1/4" to 1"	15"	12	SB80	Tampico



SB80

Radiator Bent Brush

Size	Std. Pkg.	SKU
1" X 10"	10	F125W
2" X 10"	10	F150W



F150W

Dauber Brush/Rig Brush

Brush Width	Trim Length	Overall Length	Std. Pkg.	Fill Material	SKU
4" x 3"	2"	20"	12	Union Fiber	SB1792
				Tampico	SB1793
				Palmyra	SB1794

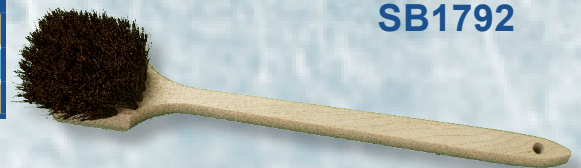

SB1792

Dope Brush

- Sturdy wood handle with union fiber mix and plastic guard.

Size	Std. Pkg.	SKU	SKU No Guard
4" x 16"	2	SB3105	SB3105-NG



SB3105

For Products without SKU, Please call Customer service and ask MOQ and Lead time.



Stucco Brush

SB1400

- Hand-crafted and built with a worker in mind - a must-have tool for the stucco industry
- Acid resistant fill and marine grade wood allow the tool to be used for multiple jobs
- Aircraft strength wire ensures the bristles will stay secure



Block Size	Std. Pkg.	SKU	FILL MATERIAL
4" x 4"	12	SB1400	ACID RESISTANT
5" x 5"	10	SB1401	ACID RESISTANT
3" x 7"	12	SB1402	ACID RESISTANT

Plaster Scratch Brush

- A great tool for plaster and stucco application
- Uses an acid resistant fill for added brush life
- Plain wood handle



Block Size	Std. Pkg.	SKU	FILL MATERIAL
10" x 1-1/4"	1	SB10114	ACID RESISTANT

Corner Brush

- For hard to reach areas such as corners, stairwells and baseboards



HANDLE TYPE	Std. Pkg.	SKU	FILL MATERIAL
THREADED	6	SB3189	SYNTHETIC

Suede Shoe Brush



Block Size	Std. Pkg.	SKU	FILL MATERIAL
3" x 1"	12	SB1022	BRASS



Ask us about our display program!



- Pegboard 48" x 60" -



Fine Sweep

Industrial-grade brooms that are for fine-sweeping applications on smooth surfaces, such as tile, linoleum, and hardwood floors that are indoors, in loading-dock areas and entrance/exit sites.



Block Size	Trim Length	Border Profile	Handle	Std. Pkg	Filaments	Item #
18	2-3/4"	STRAIGHT	Threaded	10	Horsehair Blend	M18
					Synthetic	FB118
24	2-3/4"	STRAIGHT	Threaded	10	Horsehair Blend	M24
					Synthetic	FB124
36	2-3/4"	STRAIGHT	Threaded	10	Horsehair Blend	M36
					Synthetic	FB136

Medium Sweep

Industrial-grade brooms that are for medium-sweeping applications on smoother surfaces in wet or dry applications.



Block Size	Trim Length	Border Profile	Handle	Std. Pkg	Filaments	Item #
18	2-3/4"	STRAIGHT	Threaded	10	Tampico Blend	T18
					Flagger Fibre Synthetic	BLUEBOY18
24	2-3/4"	STRAIGHT	Threaded	10	Tampico Blend	T24
					Flagger Fibre Synthetic	BLUEBOY24
36	2-3/4"	STRAIGHT	Threaded	10	Tampico Blend	T36
					Flagger Fibre Synthetic	BLUEBOY36

Heavy Sweep

Industrial-grade brooms that are for heavy-sweeping applications on uneven surfaces and maintenance areas, such as parking lots, sidewalks, playgrounds, construction sites, driveways and concrete and asphalt.



Block Size	Trim Length	Border Profile	Handle	Std. Pkg	Filaments	Item #
18	2-3/4"	STRAIGHT	Threaded	10	Synthetic	G18
24	2-3/4"	STRAIGHT	Threaded	10	Synthetic	G24

THE COMPLETE BROOM EASY TO SHIP

Felton Brushes is now offering a completed broom kit that is easy to ship all over North America.

The complete BLUE BOY is a 24" broom filled with a combination of fibres. The stiff, black polypropylene in the centre pushes heavy debris, and it is surrounded by a soft, flagged blue polystyrene that picks up dust and light debris from any surface.

The BLUE BOY comes complete with a metal

brace that strengthens the broom for the toughest jobs, and a 54"x1-1/8" lacquered wooden broom handle with a threaded metal tip.

The BLUE BOY is packaged individually, with all components included in the box, and is shipped by the dozen in a large, easy-to-ship box.

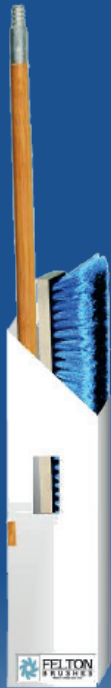

Coarse Sweep

Ideal for tough, rough and uneven surfaces with lots of debris; great for streets and roads.

Block Size	Trim Length	Border Profile	Handle	Std. Pkg	Filaments	Item #
14	2-3/4"	STRAIGHT	Threaded	10	Synthetic	P14
16					Synthetic	P16



Complete Sweep Broom

Ideal for tough, rough and uneven surfaces with lots of debris; great for streets and roads.

Block Size	Trim Length	Border Profile	Handle	Std. Pkg	Filaments	ROD	Item #
24	2-3/4"	STRAIGHT	Threaded	10	Synthetic	60" X 1-1/8" wood	BLUEBOY 24C

Floor Squeegee - Curved

- Heavy duty metal block with curved rubber squeegee.

Overall Length	Std. Pkg.	SKU
24"	2	SB3100
36"	2	SB3101



SB3101



Laquered wooden handle with black camel hair fill.



Handle Colour	Size	Ferrule Size	Overall Length	Fill	Pack Size	Item #
Black	1	.102	7-1/2"	Black Camel	12	10911
	2	.104				10912
	3	.106				10913
	4	.140				10914
	5	.146				10915
	6	.165				10916
	7	.182	7-3/4"			10917
	8	.196				10918
	10	.250	8"			109110
	12	.312	8-3/4"			109112

Plain wooden handle with white hair fill.

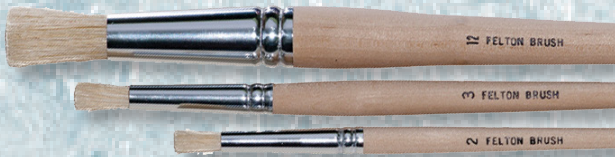

Handle Colour	Size	Overall Length	Fill	Pack Size	Item #
Beige	0	7"	White	12	0LH
	1	7-1/4"			1LH
	2				2LH
	3	8-1/4"			3LH
	4				4LH
	6				6LH
	10	8-1/2"			10LH
	12	9-1/4"			12LH

All Purpose

Straight black china bristle and a blue plastic "Beaver-tail" handle and metal ferrule. Ideal for any painting, varnishing or adhesive applications.



Width	Overall Length	Pack Size	Fill Colour	Item #
1"	9"	24	Black	PB1031
2"		24		PB1032
3"		12		PB1033
4"		12		PB1034

Economy

Straight grey bristle and a blue plastic "Beaver-tail" handle and metal ferrule. Ideal for industrial jobs that won't see multiple uses.



Width	Overall Length	Pack Size	Fill Colour	Item #
1/2"	9"	50	Black	PB1040
1"				PB1041
2"				PB1042
3"		25		PB1043
4"		15		PB1044

Classic Quality

Straight tan synthetic polyester and a blue-painted solid wooden "Beaver-tail" handle and metal ferrule. Ideal for multi use jobs; for a smooth finish on a variety of surfaces.

Width	Overall Length	Pack Size	Fill Colour	Item #
1"	9"	24	Tan	PB2021
2"		12		PB2022
3"		12		PB2023
4"		12		PB2024



All Purpose

Straight black synthetic polyester and a red plastic "Beaver-tail" handle and metal ferrule. Ideal for any painting, varnishing or adhesive applications.

Width	Overall Length	Pack Size	Fill Colour	Item #
1"	9"	24	Black	PB2031
2"		24		PB2032
3"		12		PB2033
4"		12		PB2034



Economy

Straight black synthetic polyester and a blue plastic "Beaver-tail" handle and metal ferrule. Ideal for industrial jobs that won't see multiple uses.

Width	Overall Length	Pack Size	Fill Colour	Item #
1"	9"	50	Black	PB2041
2"		50		PB2042
3"		25		PB2043
4"		15		PB2044



Sash Brush

Sash brushes with laquered wooden handles and black china bristle in a steel ferrule. Steeply angled brush head is great for detailing and raised surfaces; ideal for trim and window frame painting.

Bristle Colour	Size	Overall Length	Fill	Item #
Black	2"	8-1/2"	Pure Bristle	11502
	4"	9"		11504
	6"	9-1/4"		11506
	8"	11"		11508



Chip Brush

Chip brushes with disposable applications such as adhesives, dusting metal and wood chips, and any other painting or varnishing applications that do not need a smooth finish.

Fill	Width	Overall Length	Std. Qty	Fill Colour	Item #
Pure Bristol	1/2"	8"	36	Tan	PB3000
	1"				PB3001
	2"		24		PB3002
	3"				PB3003
	4"				12





Strip Brush

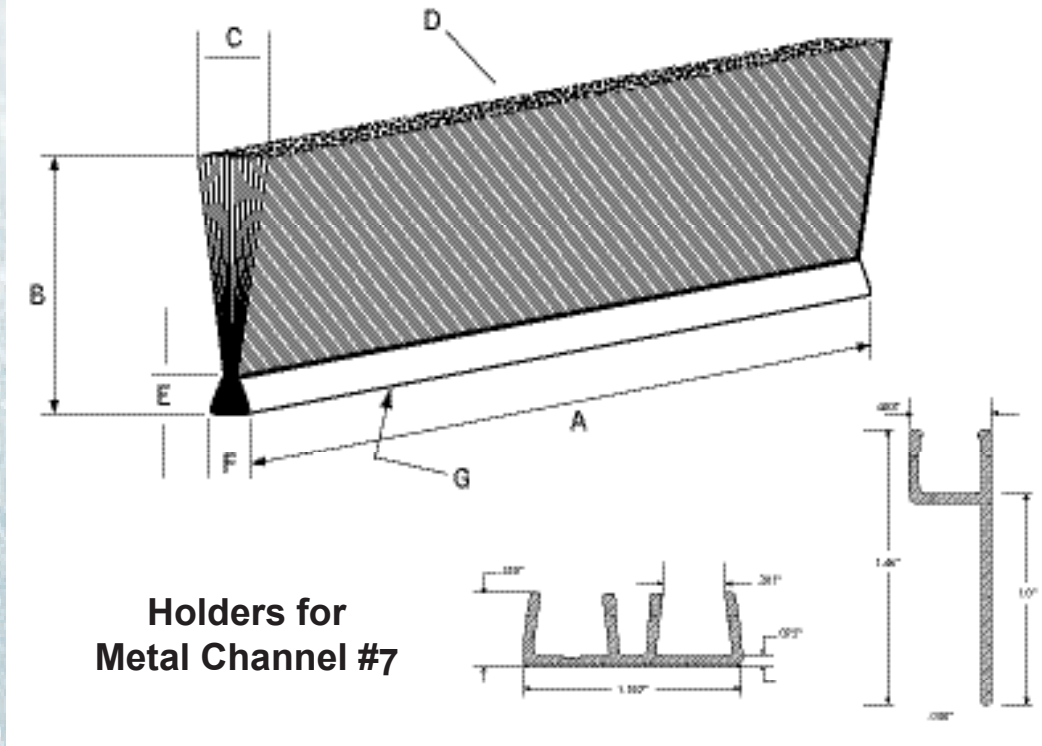

**Holder for
Metal Channel #7**

Applications:

- Spreading of powdery materials
- Dusting
- Splash guard on grinders and machine tools
- Lag Brushes
- Eliminates static electricity
- Curtains to prevent hot chips from flying
- Noise/Wind barrier
- Product guide
- Many, many more uses

Please provide all dimensions in inches (indicate any critical tolerances)

A. Brush Length: _____ B. Brush Overall Trim Height: _____

C. Brush Face Width (if applicable) _____ D. Bristle: (Poly, Nylon, Wire, Etc.) _____

Bristle Dia. _____ Colour _____ Crimped or Level _____

E. & F. Backing Height & Width: #4 = 3/16 X 3/16, #7 = 5/16 X 5/16

G. Backing Mat'l: Galvanized or Stainless _____

Quantity Required: _____

Any additional information or notes: _____

Your Company Name: _____ Phone: _____

Your Name: _____ Title: _____ Fax: _____



Spiral Wound Brush

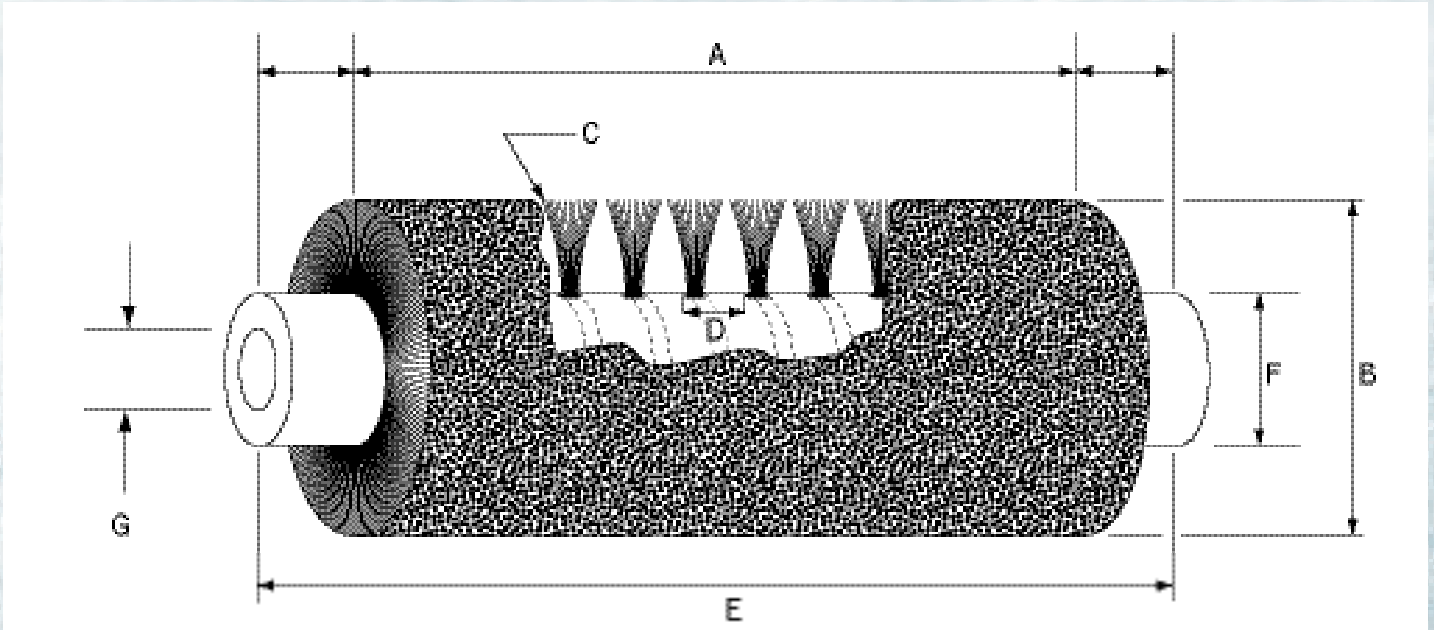

Please provide all dimensions in inches (indicate any critical tolerances)

A. Brush Length: _____ B. Brush Overall Dia.: _____ Strip Backing Size _____

C. Fill Material _____ (Poly, Nylon, Wire, Etc.) Dia. of Fill Material: _____ Crimped: _____

Level: _____ Colour: _____ D. Coil Spacing: _____ E. Core Length: _____

F. Core OD: _____ G. Bore & Key Size: _____ Or Stub Shaft? (identify) _____

Set Back (if required) _____

How is brush fastened to core: TANGS WELD HANDING

Operating RPM: _____ Wet or Dry Application: _____

Any additional information or notes: _____

Your Company Name: _____ Phone: _____

Your Name: _____ Title: _____ Fax: _____

Spiral-Wound Coil Brushes

A continuous brush strip is spirally wrapped to form a cylindric brush. The brush is then mounted onto a core or shaft for use. Cores can be disposable or reusable, depending on various factors.

Replacement brush coils are available for field installation on reusable cores.

A wide variety of materials, densities and sizes are available to satisfy a wide range of applications, including scrubbing, finishing, polishing, applying, spreading and removing.



Twisted in Wire Brush

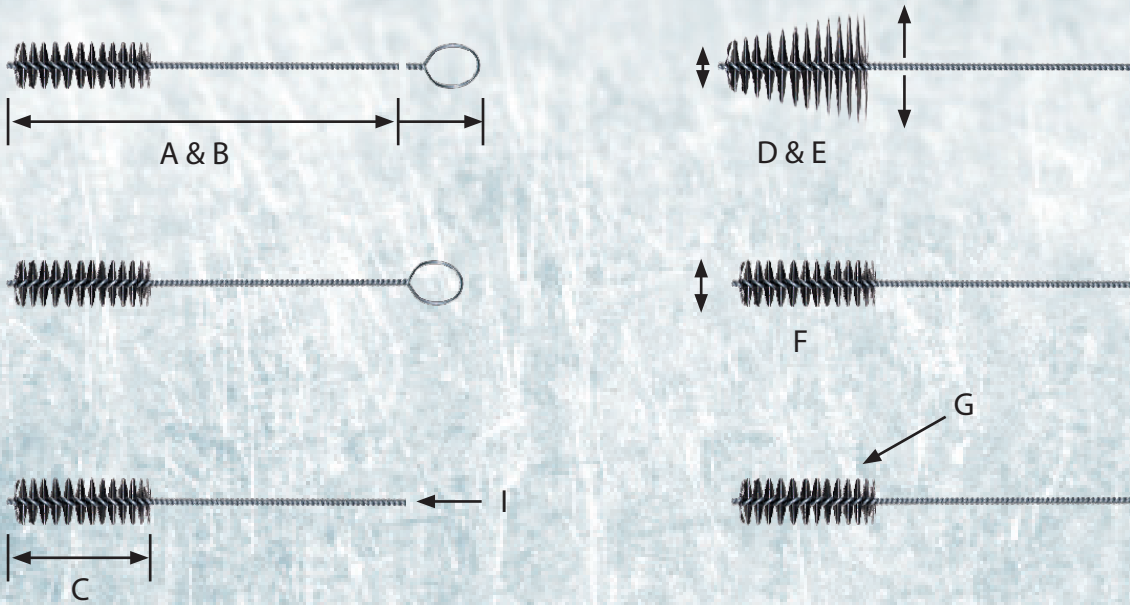

Please provide all dimensions in inches (indicate any critical tolerances)

A. Overall Length: _____ B. With Loop: or Without Loop:

C. Length of Brush Part: _____ D. Is Brush Part Tapered? YES NO

E. Tapered Measurements From _____ to _____ F. Dia. of Brush _____

G. Fill Mat'l: Nylon Poly Carbon Steel SS Brass H. Dia. of Fill Mat'l _____

I. Stem Dia.: _____ Double Stem: YES NO Double Spiral: YES NO

Application of above Brush: _____

Your Company Name: _____ Phone: _____

Your Name: _____ Title: _____ Fax: _____

Twisted brushes utilize a carbon or stainless steel wire into which various fill materials can be twisted to make the brush to suit your needs!
Les brosses tordues utilisent des fils de carbone ou d'acier inoxydable dans lequel les matériaux peuvent être tordus pour vous donner une brosse selon votre besoin!



Major (Medium/Wide Face) Bench Wheels

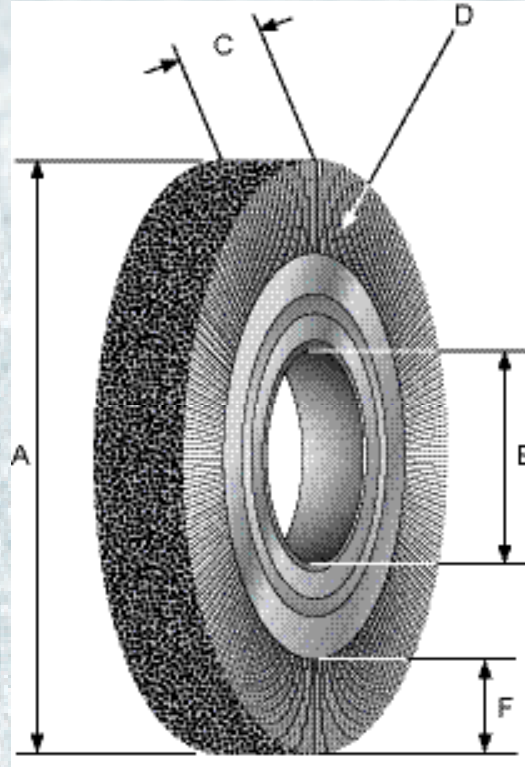

Please provide all dimensions in inches (indicate any critical tolerances)

A. Outside Dia. (O.D.): _____ B. Inside Dia. (I.D.): _____ C. Brush Face _____

D. Fill Material: _____ E. Dia. of Fill Material: _____ F. Trim: _____

Operating RPM: _____ Wet or Dry Application: _____

Any additional information or notes: _____

Your Company Name: _____ Phone: _____

Your Name: _____ Title: _____ Fax: _____

Is a drawing available: _____

Major (Medium/Wide Face) Bench Wheel

For all-purpose portable or stationary brushing. A brush that provides excellent performance for a broad range of industrial applications – edge blending, deburring surface roughing, dust removal

and many other jobs. The wheels have a standard 2" arbour hole, and for the 4" wheels the arbour hole size is 1-1/8".

Available in many different type of filaments.



FELTON BRUSHES

Made in Canada Since 1933

Felton Brushes Ltd.
29 Harriet Street
Hamilton, Ontario
T 1.800.991.7272
F 1.905.522.4057
sales@feltonbrushes.com
www.feltonbrushes.com

Distributed By:

