



2430G

ERGO™ Long Snipe Nose Pliers with Self Opening Dual-Component Handles and Phosphate Finish



PRODUCT DETAILS

- Two-component ERGO™ handles: thermoplastic surface on tough polypropylene provides superior grip
- Snipe nose pliers developed according to the scientific ERGO™ process
- Suitable for cutting Cu, Fe and Fe+ wire
- Equipped with a return spring featuring an on/off function
- High-performance alloy steel
- Phosphate finish, anti-corrosion treated
- Tips give a good grip and improved accessibility in confined spaces
- Slim semi-circular shaped and serrated jaws
- Sharp cutting edges for cutting softer material such as copper and plastic insulated wire
- Maximum comfort with minimum effort due to ergonomic design
- Comfortable two-component handles provide excellent grip
- Angled tips give good grip and improved accessibility in confined spaces
- Self-opening handles when spring activated

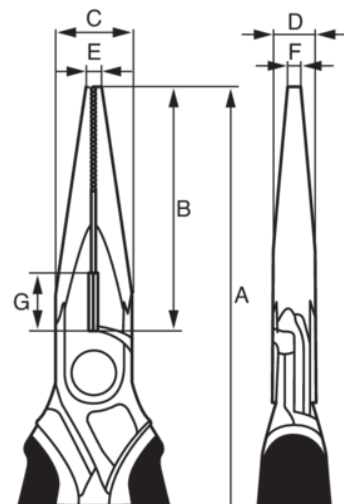





Follow the Fish!







PRODUCT ATTRIBUTES





Product: 2430 G-140

B	37 mm	C	15 mm	D	7,8 mm
E	2,5 mm	F	2 mm	G	12 mm
	2.5 mm		1.8 mm		1.4 mm
	120 g				





Product: 2430 G-160

B	51 mm	C	16,5 mm	D	8,8 mm
E	3 mm	F	2.5 mm	G	12 mm
	3.0 mm		1.8 mm		1.6 mm
	160 g				





Product: 2430 G-200

B	72 mm	C	17 mm	D	9,3 mm
E	3 mm	F	2.5 mm	G	12 mm
	3.0 mm		1.8 mm		1.6 mm
	170 g				





Product: 2430 G-140 IP

B	37 mm	C	15 mm	D	7,8 mm
E	2,5 mm	F	2 mm	G	12 mm
	2.5 mm		1.8 mm		1.4 mm
	120 g				

Product: 2430 G-160 IP

B	51 mm	C	16,5 mm	D	8,8 mm
E	3 mm	F	2.5 mm	G	12 mm
	3.0 mm		1.8 mm		1.6 mm
	160 g				

Product: 2430 G-200 IP

B	72 mm	C	17 mm	D	9,3 mm
E	3 mm	F	2.5 mm	G	12 mm
	3.0 mm		1.8 mm		1.6 mm
	170 g				

