



BODY SHOP FASTENERS

QUALITY PRODUCTS
 PRODUIT DE QUALITE



INTERIOR
 EXTERIOR
 INTERIEUR
 EXTERIEUR

ATTACHES A CARROSSERIE



Name	Page
BOLTS	
Misc. Bolts	20
Body Bolts (Inch & Metric).....	17-20
Bumper Bar Bolts (Inch & Metric).....	15-17
BUSHINGS	
Door Hinge Bushings.....	75
CLIPS	
'T' Bolt Clis (Inch).....	21
Moulding Clips & Retainers.....	23
DOOR PINS	
Door Pins.....	74-75
STORAGE & ASSORTMENTS	
Bolt Bins.....	94
Bulk Bins.....	94
Master Assortments.....	90-93
Stax-Six Cabinet.....	90
MERCHANDISERS	
Collision Repair Merchandiser	96-99
PLUGS	
Metal Plugs	24
MISC. EXT.	
Miscellaneous.....	83
NUTS	
Assorted Nuts (Metric).....	13-14
Flat Type Speed Nuts (Inch).....	8
Formed Speed Nuts (Inch).....	8-9
Licence Plate Bolt & Nut Assembly (Inch).....	20
Licence Plate Nuts (Inch).....	20
Licence Plate Screws.....	22
Misc. Nuts (Inch).....	8
Push-On Speed Nuts (Inch).....	9
Self-Threading Palnuts (Inch).....	11-12
Tubular Speed Nuts (Inch).....	9
'U' Nuts (Inch).....	9-10
(Metric).....	10-11
PINS	
Weld Pins.....	78
RETAINERS	
Bolt Retainers (Inch).....	12-13
(Metric).....	13
Interior Retainers. Domestic Brands.	
AMC.....	26
Chrysler.....	26-27
Ford.....	28-29

Name	Page
GM.....	30-32
Interior Retainers. Imported Brands	
BMW.....	34
Honda.....	34-35
Hyundai.....	36
KIA.....	36
Lexus.....	36
Mazda.....	36-37
Mercedes-Benz.....	37
Mitsubishi.....	37
Nissan.....	38
Toyota.....	39
Volkswagen.....	40
Exterior Retainers. Domestic Brands.	
AMC.....	42
Chrysler.....	42-46
Ford.....	46-50
GM.....	50-58
Jeep.....	58
Exterior Retainers. Imported Brands.	
BMW.....	60
Honda.....	60-63
Hyundai.....	63-64
Isuzu.....	64
KIA.....	64
Lexus.....	65
Mazda.....	66
Mercedes-Benz	67
Mitsubishi.....	67
Nissan.....	67-69
Toyota.....	69-71
VW	71
RIVETS	
Aluminum Rivets.....	80-81
Steel & Plastic Rivets.....	78-80
Stainless Rivets.....	82
Steel Rivets.....	81-82
SCREWS	
Licence Plate Srews (Inch).....	22
(Metric).....	22
Tapping Screws.....	3, 6-7
Trim Screws.....	3-5
SHIMS	
Body & Hood Shims.....	23
TOOLS	
Tools.....	85-87
WALL CHARTS	
Wall Charts	98
WASHERS	
Fender Washer.....	3



Fender Washer Zinc Plated

Std. Pkg. 100 pcs.

Part No.	Bolt Size	Outside Dia.
162-394	3/16	3/4
162-395	1/4	1-1/4
162-396	5/16	1
162-397	5/16	1-1/4
162-398	3/8	1-1/2
162-399	5/16	1-1/16
162-400	1/2	2



CL Part No.	Part No.	Bolt Size	Pieces
910-1700	162-394	3/16	12
910-1703	162-395	1/4	8
910-1706	162-397	5/16	9
910-1707	162-399	5/16	6



Pan Phillips Head Black Oxide

Std. Pkg. 100 pcs.

Part No.	Dia x Length	Part No.	Dia x Length
229-960	6x1/2	229-972	8x1
229-962	8x1/2	229-980	10x3/4
229-968	8x3/4	229-982	10x1



Pan Socket 'Loxxon' Head Zinc

Std. Pkg. 100 pcs.

Part No.	Dia x Length	Part No.	Dia x Length
208-039	4x1/4	208-187	10x3/8
208-041	4x3/8	208-189	10x1/2
208-043	4x1/2	208-190	10x5/8
208-045	4x3/4	208-191	10x3/4
208-047	4x1	208-193	10x1
208-083	6x1/4	208-195	10x1-1/4
208-085	6x3/8	208-197	10x1-1/2
208-087	6x1/2	208-200	10x2
208-088	6x5/8	208-246	12x1/2
208-089	6x3/4	208-248	12x3/4
208-091	6x1	208-250	12x1
208-093	6x1-1/4	208-252	12x1-1/4
208-095	6x1-1/2	208-254	12x1-1/2
208-135	8x3/8	208-257	12x2
208-137	8x1/2	208-277	14x5/8
208-138	8x5/8	208-278	14x3/4
208-139	8x3/4	208-280	14x1
208-141	8x1	208-282	14x1-1/4
208-143	8x1-1/4	208-284	14x1-1/2
208-145	8x1-1/2	208-287	14x2
208-148	8x2		

Indented Hex Slotted Washer Head Zinc

Std. Pkg. 100 pcs.

Part No.	Dia x Length	Part No.	Dia x Length
213-085	6x3/8	213-250	12x1
213-137	8x1/2	213-276	14x1/2
213-139	8x3/4	213-277	14x5/8
213-141	8x1	213-278	14x3/4
213-143	8x1-1/4	213-280	14x1
213-145	8x1-1/2	213-282	14x1-1/4
213-187	10x3/8	213-284	14x1-1/2
213-189	10x1/2	213-442	5/16x3/4
213-190	10x5/8	213-444	5/16x1
213-191	10x3/4	213-446	5/16x1-1/4
213-193	10x1	213-448	5/16x1-1/2
213-246	12x1/2	213-489	3/8x1
213-248	12x3/4	213-493	3/8x1-1/2



CL Part No.	Part No.	Dia x Length	Pieces
910-1080	213-137	8x1/2	12
910-1090	213-191	10x3/4	12
910-1105	213-278	14x3/4	6



This item is also available in clamshell clear pack

**Oval Phillips Regular Head Zinc Plated**

Std. Pkg. 100 pcs.

Part No.	Dia x Length	Part No.	Dia x Length
229-010	6x1/2	229-024	8x1
229-012	6x3/4	229-026	8x1-1/4
229-014	6x1	229-041	10x5/8
229-016	6x1-1/4	229-044	10x1
229-022	8x3/4	229-320	8x1/2



CL Part No.	Part No.	Dia x Length	Pieces
910-1035	229-022	8x3/4	15
910-1040	229-024	8x1	15
910-1045	229-026	8x1-1/4	12
910-1050	229-044	10x1	12
910-1030	229-320	8x1/2	15



Std. Pkg. 100 pcs.

Pan Phillips Head Zinc Plated Regular Head

Part No.	Dia x Length	Part No.	Dia x Length
229-108	6x3/8	229-140	10x1/2
229-110	6x1/2	229-142	10x3/4
229-119	8x3/8	229-144	10x1
229-120	8x1/2	229-160	12x1/2
229-122	8x3/4	229-164	12x1
229-124	8x1		



CL Part No.	Part No.	Dia x Length	Pieces
910-1005	229-120	8x1/2	15
910-1010	229-122	8x3/4	12
910-1020	229-142	10x3/4	12



Std. Pkg. 100 pcs.

Round Washer Head Phillips Black

Part No.	Dia x Length	Part No.	Dia x Length
229-401	8x1/2	229-407	8x1-1/4
229-402	8x5/8	229-414	10x3/4
229-403	8x3/4	229-416	10x1
229-405	8x1		



CL Part No.	Part No.	Dia x Length	Pieces
910-1220	229-401	8x1/2	12
910-1225	229-403	8x3/4	10
910-1230	229-405	8x1	10
910-1235	229-414	10x3/4	6
910-1237	229-416	10x1	5



Std. Pkg. 50 pcs.

Washer Head Phillips Teks® Point Zinc - GM

Part No.	Dia x Length	Part No.	Dia x Length
230-501	8x1/2		



CL Part No.	Part No.	Dia x Length	Pieces
910-1155	230-501	8x1/2	8

**Round Washer Head Pozi-Driv®**

Std. Pkg. 100 pcs.

Chrome Plated		Black Oxide	
Part No.	Dia x Length	Part No.	Dia x Length
230-301	4.2x8mm	230-303	4.2x12mm
230-302	4.2x12mm	230-306	4.2x20mm
230-304	4.2x16mm		
230-305	4.2x20mm		



CL Part No.	Part No.	Dia x Length	Pieces
910-1245	230-306	4.2x20mm	10



Std. Pkg. 100 pcs.

Flat Top Washer Head Phillips Zinc

Part No.	Dia x Length	Part No.	Dia x Length
229-421	8x1/2	229-423	8x3/4



CL Part No.	Part No.	Dia x Length	Pieces
910-1111	229-421	8x1/2	10
910-1113	229-423	8x3/4	10

**Flat Top Washer Head Phillips Black**

Std. Pkg. 100 pcs.

Part No.	Dia x Length	Part No.	Dia x Length
229-903	8x1/2	229-906	8x1
229-904	8x5/8	229-907	10x3/4
229-905	8x3/4	229-908	10x1



This item is also available in clamshell clear pack

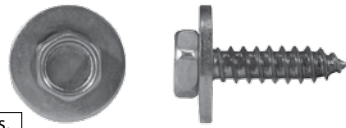

Std. Pkg. 50 pcs.

Indented Washer Head Hex Sems® Yellow Zinc

Part No.	Dia x Length	Part No.	Dia x Length
229-575	10x3/4		



CL Part No.	Part No.	Dia x Length	Pieces
910-1280	229-575	10x3/4	2



Oval Phillips Zinc Plated

Std. Pkg. 100 pcs.

No. 6 Head - Small		No. 8 Head - Regular	
Part No.	Dia x Length	Part No.	Dia x Length
229-219	8x3/8	229-240	10x1/2
229-220	8x1/2	229-241	10x5/8
229-222	8x3/4	229-242	10x3/4
229-224	8x1	229-244	10x1
229-225	8x1-1/8	229-248	10x1-1/2
229-226	8x1-1/4	229-250	10x2
229-227	8x1-3/8	229-252	10x2-1/2
229-228	8x1-1/2		
229-229	8x1-3/4		



CL Part No.	Part No.	Dia x Length	Pieces
910-1070	229-224	8x1	10



Oval Phillips Sems®

Std. Pkg. 50 pcs.

Chrome Plated		Black Phosphate	
Part No.	Dia x Length	Part No.	Dia x Length
229-806	6x3/4		
No. 6 Head w/Countersunk Washer			
229-811	8x3/4	229-849	8x5/8
229-815	8x1	229-851	8x3/4
229-819	8x1-1/4	229-855	8x1
		229-856	8x1-1/4
No. 8 Head w/Countersunk Washer			
229-833	10x3/4	229-883	10x3/4
229-837	10x1	229-887	10x1



CL Part No.	Part No.	Dia x Length	Pieces
910-1165	229-811	8x3/4	7
910-1167	229-815	8x1	6
910-1170	229-837	10x1	5
910-1180	229-812	8x7/8	6
910-1260	229-851	8x3/4	8
910-1262	229-855	8x1	8
910-1263	229-856	8x1-1/4	6



Std. Pkg. 100 pcs.

Oval Washer Head Phillips - Small Head (#6)

Chrome			
Part No.	Dia x Length		
229-862	8x7/8		



CL Part No.	Part No.	Dia x Length	Pieces
910-1180	229-862	8x7/8	6



Std. Pkg. 100 pcs.

Oval Head Phillips Sems® Flush Washer

Black		Chrome	
Part No.	Dia x Length	Part No.	Dia x Length
229-864	8x1-1/4		



CL Part No.	Part No.	Dia x Length	Pieces
910-1210	229-864	8x1-1/4	8



Oval Head Phillips Black Oxide

Std. Pkg. 100 pcs.

Part No.	Dia x Length	Part No.	Dia x Length
229-912	8x3/4	229-916	8x1
No. 6 Head - small			
229-911	8x3/4	229-919	8x1-1/4
229-915	8x1	229-923	8x1-1/2
No. 8 Head - small			
229-933	10x3/4	229-945	10x1-1/2
229-937	10x1		



Oval Phillips Sems®

Std. Pkg. 50 pcs.

Chrome Plated		Black Phosphate	
Part No.	Dia x Length	Part No.	Dia x Length
229-985	8x3/4	229-987	8x3/4
229-986	8x1	229-988	8x1
230-502	8x1/2		



This item is also available in clamshell clear pack



Std. Pkg. 100 pcs.

Metric Pan Pozi-Driv® Head Chrome Plated

Part No.	Dia x Length	Part No.	Dia x Length
230-203	4.2x13mm	230-206	4.2x20mm
230-205	4.2x20mm		



Std. Pkg. 100 pcs.

Metric Oval Pozi-Driv® Head Chrome Plated

Part No.	Dia x Length	Part No.	Dia x Length
230-207	4.2x20mm		



Std. Pkg. 100 pcs.

Special Tapping Screws Black

Part No.	Dia x Length	Part No.	Dia x Length
230-619	M4.8-1.61x19mm		



Std. Pkg. 100 pcs.

Special Tapping Screws Black

Part No.	Dia x Length	Part No.	Dia x Length
230-623	M4.2-1.41x20mm		



CL Part No.	Part No.	Dia x Length	Pieces
910-1275	230-619	M4.8-1.61x19mm	3



CL Part No.	Part No.	Dia x Length	Pieces
910-1270	230-623	M4.2-1.41x20mm	3

**Metric Oval 6-Lobe Head 18.8 Stainless**

Std. Pkg. 25 pcs.

Chrome Plated		Black Oxide	
Part No.	Dia x Length	Part No.	Dia x Length
231-205	4.2x20mm	231-206	4.2x20mm
231-209	4.2x30mm	231-210	4.2x30mm
231-213	4.2x40mm		
231-219	4.2x55mm		

**Metric Pan 6-Lobe Head 18.8 Stainless**

Std. Pkg. 25 pcs.

Chrome Plated		Black Oxide	
Part No.	Dia x Length	Part No.	Dia x Length
231-251	4.2x20mm	231-252	4.2x20mm
231-257	4.2x35mm	231-264	4.2x50mm

MACHINE SCREWS

VIS DE MÉCANIQUE



Std. Pkg. 100 pcs.

Round Phillips Head Machine Screw Zinc Plated

Part No.	Dia x Length	Part No.	Dia x Length
173-085	6-32x3/8	173-193	10-24x1
173-135	8-32x3/8	173-215	10-32x3/8
173-137	8-32x1/2	173-217	10-32x1/2
173-139	8-32x3/4	173-219	10-32x3/4
173-141	8-32x1	173-305	1/4-20x1/2
173-189	10-24x1/2	173-307	1/4-20x3/4
173-191	10-24x3/4	173-309	1/4-20x1



Std. Pkg. 100 pcs.

Oval Phillips Head Machine Screw Zinc Plated

Part No.	Dia x Length	Part No.	Dia x Length
175-137	8-32x1/2	175-191	10-24x3/4
175-139	8-32x3/4	175-217	10-32x1/2
175-141	8-32x1	175-307	1/4-20x3/4





Std. Pkg. 100 pcs.

Phillips Washer Head

Black		Zinc	
Part No.	Dia x Length	Part No.	Dia x Length
230-403	8x3/4	230-260	8x7/16



CL Part No.	Part No.	Dia x Length	Pieces
910-1110	230-260	8x7/16	20
910-1226	230-403	8x3/4	10



Std. Pkg. 50 pcs.

Phillips Washer Head with TEKS® Point Black

Part No.	Dia x Length	Part No.	Dia x Length
230-502	8x1/2	230-504	8x3/4



CL Part No.	Part No.	Dia x Length	Pieces
910-1290	230-502	8x1/2	8
910-1291	230-504	8x3/4	5



Std. Pkg. 100 pcs.

Phillips Round Washer Head Chrome

Part No.	Dia x Length	Part No.	Dia x Length
230-602	8x5/8		



CL Part No.	Part No.	Dia x Length	Pieces
910-1120	230-602	8x5/8	10



Std. Pkg. 100 pcs.

Phillips Flat Head Black

Part No.	Dia x Length	Part No.	Dia x Length
245-618	8x3/4		



CL Part No.	Part No.	Dia x Length	Pieces
910-1200	245-618	8x3/4	12



Std. Pkg. 50 pcs.

Hex Head SEMS® with TEKS® Point

Black		Chrome	
Part No.	Dia x Length	Part No.	Dia x Length
230-621	8x25/32	230-620	8x5/8
230-622	8x25/32		



CL Part No.	Part No.	Dia x Length	Pieces
910-1295	230-620	8x5/8	4
910-1296	230-621	8x25/32	5
910-1297	230-622	8x25/32	4



Std. Pkg. 100 pcs.

Hex Washer Head with TEKS® Self-Drilling Zinc

Part No.	Dia x Length	Part No.	Dia x Length
232-071	8x1/2	232-080	10x3/4
232-073	8x3/4		



CL Part No.	Part No.	Dia x Length	Pieces
910-1140	232-071	8x1/2	15
910-1142	232-073	8x3/4	15
910-1147	232-080	10x3/4	12

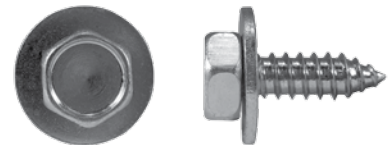

Std. Pkg. 100 pcs.

Hex Head SEMS® Zinc

Part No.	Dia x Length	Part No.	Dia x Length
245-600	14x3/4		



CL Part No.	Part No.	Dia x Length	Pieces
910-0009	245-600	14x3/4	5



This item is also available in clamshell clear pack

MISC. NUTS



184-010

Std. Pkg. 100 pcs.

Machine Screw Size: No. 10-24

Hexagon Machine Screw Nut
Hex Width: 3/8

CL Part No: 910-1728, Pieces: 20



239-960

Std. Pkg. 25 pcs.

1/4-20

CHRYSLER, GM
Mirror Mounting 'Jack Nut' w/Sealer
use with 245 - 610
CHRYSLER #6031438, GM #367292

CL Part No: 910-1660, Pieces: 1



239-991

Std. Pkg. 10 pcs.

1/4-20

AMC, GM
Blind Well Nut
Hole Size: 1/2", Head Dia .625, Overall Length: .642
AMC #4003120, GM #528846

CL Part No: 910-1665, Pieces: 2

FLAT TYPE SPEED NUTS



240-100

Std. Pkg. 100 pcs.

Machine Screw Size: No. 8-32

Flat Type Speed Nut
Machine Screw Size: No. 8-32, 5/16" x 1/2"

CL Part No: 910-1465, Pieces: 7



240-101

Std. Pkg. 100 pcs.

Machine Screw Size: No. 8-32

Flat Type Speed Nut
Machine Screw Size: No. 8-32, 1/2" x 7/8"

240-120

Std. Pkg. 100 pcs.

Machine Screw Size: No. 10-24

Flat Type Speed Nut
Machine Screw Size: No. 10-24, 7/16" x 3/4"

FORMED TYPE SPEED NUTS

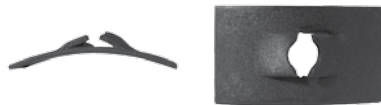

240-127

Std. Pkg. 100 pcs.

Tapping Screw Size: No. 10

Flat Type Speed Nut
Tapping Screw Size: No. 10, 1/2" x 7/8"

CL Part No: 910-1460, Pieces: 6



240-226

Std. Pkg. 100 pcs.

Machine Screw Size: No. 8

Phosphate Formed Speed Nut
Ctr. of Hole to Edge: 1/4",
Panel Range: .025"-.040"
#9428481

240-228

Std. Pkg. 100 pcs.

Screw Size: No. 8

Formed Speed Nut
Ctr. of Hole to Edge: 11/32",
Panel Range: .025"-.035"
#9427761

CL Part No: 910-1481, Pieces: 6



240-230

Std. Pkg. 100 pcs.

Screw Size: No. 8

GM
Formed Speed Nut
Ctr. of Hole to Edge: 3/8", Panel Range: .045"-.062"
#445429, 9422552

CL Part No: 910-1482, Pieces: 4



240-242

Std. Pkg. 100 pcs.

Machine Screw Size: No. 10

Formed Speed Nut
Ctr. of Hole to Edge: 11/32"
Panel Range: .025"-.060"

CL Part No: 910-1491, Pieces: 6



240-243

Std. Pkg. 100 pcs.

Machine Screw Size: No. 10-24

Formed Speed Nut
Ctr. of Hole to Edge: 9/16"
Panel Range: .045"-.062"

CL Part No: 910-1500, Pieces: 5



240-250 Std. Pkg. 100 pcs.

Screw Size: No. 10

Formed Speed Nut
Ctr. of Hole to Edge: 3/8"
Panel Range: .025"-.064"

CL Part No: 910-1490, Pieces: 6



240-263 Std. Pkg. 100 pcs.

Screw Size: 1/4-20

GM
Formed Speed Nut
Ctr. of Hole to Edge: 9/16", Panel Range .064"-.125"
#9431647

CL Part No: 910-1505, Pieces: 6



240-267 Std. Pkg. 100 pcs.

Screw Size: No. 14

Formed Speed Nut
Ctr. of Hole to Edge: 15/32"
Panel Range: .028"-.056"

CL Part No: 910-1495, Pieces: 3

PUSH-ON TYPE SPEED NUTS



240-269 Std. Pkg. 25 pcs.

Screw Size: No. 14

GM
Formed Speed Nut
Ctr. of Hole to Edge: 5/16", Panel Range .025"-.150"
#9425491

CL Part No: 910-1531, Pieces: 3



240-335 Std. Pkg. 100 pcs.

Stud Size : 1/8"

Push-On Speed Nut
37/64 x 5/16, Thickness: .012

CL Part No: 910-1450, Pieces: 10



240-350 Std. Pkg. 100 pcs.

Stud Size: 3/16"

Push-On Speed Nut
5/8 x 3/8, Thickness: .017

CL Part No: 910-1455, Pieces: 10

TUBULAR TYPE SPEED NUT



240-430 Std. Pkg. 100 pcs.

Stud Size: 1/8"

Tubular Type Speed Nut
Fits into 5/32" Hole,
Panel Range: .030"-.036"



240-432 Std. Pkg. 100 pcs.

Stud Size: 1/8"

Tubular Type Speed Nut
Fits into 1/4" Hole, Panel Range: .036"-.046"
#375480-5100, 3783794

CL Part No: 910-1575, Pieces: 8



240-471 Std. Pkg. 100 pcs.

Stud Size: 3/16"

Tubular Type Speed Nut
Fits into 7/32" Hole,
Panel Range: .038"-.044"
#6000558

'U' NUT



240-613 Std. Pkg. 25 pcs.

Screw Size: No. 14 (1/4")

TOYOTA
Nylon "U" Nut Fender/Wheel Housing Applications
Ctr. of Hole to Edge: 15mm, Panel Range: Up to 1mm,
20mm Wide, 29mm Long
#53879-22010



240-614 Std. Pkg. 25 pcs.

Screw Size: 1/4-20

GM
'U' Nut
Ctr. of Hole to Edge: 17/32", Panel Range: .025"-.150"
#1480627, 1494252

CL Part No: 910-1405, Pieces: 3



240-615 Std. Pkg. 25 pcs.

Screw Size: 1/4-20

FORD, GM
'U' Nut
Ctr. of Hole to Edge: 25/32", Panel Range: .025"-.150"
#45267, 1494257

CL Part No: 910-1406, Pieces: 3



240-616

Std. Pkg. 25 pcs.

Screw Size: 5/16-18

CHRYSLER, FORD
'U' NutCtr. of Hole to Edge: 9/16", Panel Range: .025"-.150"
CHRYSLER #6023171, FORD #45264

CL Part No: 910-1407, Pieces: 3



240-617

Std. Pkg. 25 pcs.

Screw Size: 5/16-18

FORD, GM
'U' NutCtr. of Hole to Edge: 27/32", Panel Range: .025"-.150"
#379831-S, 1494258

CL Part No: 910-1408, Pieces: 2



240-618

Std. Pkg. 25 pcs.

Screw Size: 3/8-16

FORD
'U' NutCtr. of Hole to Edge: 1 - 1/8", Panel Range: .050"-.200"
#45269

CL Part No: 910-1410, Pieces: 2



240-619

Std. Pkg. 25 pcs.

Screw Size: 3/8-16

FORD, GM
'U' NutCtr. of Hole to Edge: 3/4", Panel Range: .050"-.200"
#1494254, 45265-S2, 12337873

CL Part No: 910-1409, Pieces: 2



240-706

Std. Pkg. 25 pcs.

Screw Size: No. 6

Single Thread 'U' Nut
Ctr. of Hole to Edge: 3/8",
Panel Range: .025"-.125"

CL Part No: 910-1515, Pieces: 5



240-708

Std. Pkg. 25 pcs.

Screw Size: No. 8

GM, FORD
Formed Speed NutCtr. of Hole to Edge: 3/8", Panel Range: .025"-.150"
#9424837, 9431530; 381818-S2

CL Part No: 910-1480, Pieces: 6



240-709

Std. Pkg. 25 pcs.

Screw Size: No. 8

GM, FORD
Single Thread 'U' NutCtr. of Hole to Edge: 5/8", Panel Range: .025"-.150"
#9440178, 11504531, 381863-S2

CL Part No: 910-1520, Pieces: 6



240-710

Std. Pkg. 25 pcs.

Screw Size: No. 10

Single Thread 'U' Nut
Ctr. of Hole to Edge: 13/32",
Panel Range: .025- .125
Unknown OEM #152492

CL Part No: 910-1525, Pieces: 3

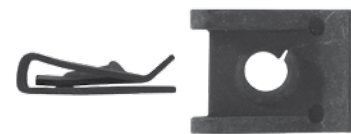

240-714

Std. Pkg. 25 pcs.

Screw Size: No. 14

Single Thread 'U' Nut
Ctr. of Hole to Edge: 13/32",
Panel Thickness: .156
Unknown OEM #45258

CL Part No: 910-1530, Pieces: 3



240-717

Std. Pkg. 25 pcs.

Screw Size: No. 8

'U' Nut

Ctr. of Hole to Edge: 7/32",
Panel Range: .094"-.109"
#25527289

CL Part No: 910-1483, Pieces: 5



241-604

Std. Pkg. 25 pcs.

Screw Size: M4-.7

FORD, GM
Zinc Organic 'U' Nut
Ctr. of Hole to Edge: 9.5mm,
Panel Range: .60mm-3.8mm
FORD #N623330-S2, GM #11500654

241-605

Std. Pkg. 25 pcs.

Screw Size: M4-.7

GM
Phosphate 'U' Nut
Ctr. of Hole to Edge: 13.5mm,
Panel Range: .80mm-4.00mm
#11500655

**241-606**

Std. Pkg. 25 pcs.

Screw Size: M6-1.0FORD, GM
Metric 'U' NutCtr. of Hole to Edge: 13.5 mm, Panel Range: .80mm-4mm
#11503957, 1016937, N623332-S2, N623332-S53, N623332-S100**CL Part No: 910-1420, Pieces: 3****241-607**

Std. Pkg. 25 pcs.

Screw Size: M6-1.0GM
Metric 'U' NutCtr. of Hole to Edge: 19.5mm, Panel Range: .34mm-4mm
#11503715, 11508241, 11609385**CL Part No: 910-1421, Pieces: 2****241-608**

Std. Pkg. 25 pcs.

Screw Size: M8-1.25FORD, GM
Metric 'U' NutCtr. of Hole to Edge: 20mm, Panel Range: .80mm-4.5mm
#11500661, 11503317, 11516150, N623343-S2, N623343-S100**CL Part No: 910-1430, Pieces: 2****241-609**

Std. Pkg. 25 pcs.

Screw Size: M8-1.25CHRYSLER, FORD, GM
Metric 'U' NutCtr. of Hole to Edge: 14.5mm, Panel Range: .80mm-4mm
#11500660, 11502617, N623333-S2, 6101283**CL Part No: 910-1427, Pieces: 3****241-610**

Std. Pkg. 10 pcs.

Screw Size: M10-1.5GM
Metric 'U' NutCtr. of Hole to Edge: 19mm, Panel Range: 1mm-6mm
#11500662, 22531616**CL Part No: 910-1435, Pieces: 2****241-612**

Std. Pkg. 25 pcs.

Screw Size: M6-3x1.0Metric 'U' Nut
Ctr. of Hole to Edge: 13.5mm, Panel Range: .80mm-4mm
#11500658, 9433043**CL Part No: 910-1425, Pieces: 3****SELF-THREADING PALNUTS****242-206**

Std. Pkg. 50 pcs.

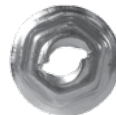
Stud Size : 1/8"Self-Threading Palnut
7/16" O.D., 5/16" Hex**CL Part No: 910-1605, Pieces: 12****242-208**

Std. Pkg. 100 pcs.

Stud Size : 5/32"Self-Threading Palnut
9/16" O.D., 3/8" Hex, Zinc**CL Part No: 910-1606, Pieces: 10****242-210**

Std. Pkg. 50 pcs.

Stud Size : 3/16"Self-Threading Palnut
1/2" O.D., 3/8" Hex**CL Part No: 910-1607, Pieces: 12**



242-214

Std. Pkg. 50 pcs.

Stud Size : 1/4"

Self-Threading Palnut
11/16" O.D., 7/16" Hex

CL Part No: 910-1608, Pieces: 10

242-216

Std. Pkg. 50 pcs.

Stud Size: 5/16"

Self-Threading Palnut
7/8" O.D., 1/2" Hex

BOLT RETAINERS



242-308

Std. Pkg. 100 pcs.

Stud Size: 5/32"

Push-On Bolt Retainer
3/8" O.D.

CL Part No: 910-1740, Pieces: 12

242-310

Std. Pkg. 100 pcs.

Stud Size: 3/16"

Bolt Retainer
7/16" O.D.
#6029348

242-314

Std. Pkg. 100 pcs.

Stud Size: 1/4"

Push-On Bolt Retainer
1/2" O.D.

CL Part No: 910-1742, Pieces: 12



242-316

Std. Pkg. 100 pcs.

Stud Size: 5/16"

Push-On Bolt Retainer
5/8" O.D.

CL Part No: 910-1743, Pieces: 12

242-318

Std. Pkg. 100 pcs.

Stud Size: 3/8"

Push-On Bolt Retainer
25/32" O.D.

CL Part No: 910-1744, Pieces: 12

242-320

Std. Pkg. 100 pcs.

Stud Size: 7/16"

Push-On Bolt Retainer
27/32" O.D.

CL Part No: 910-1745, Pieces: 12



242-322

Std. Pkg. 100 pcs.

Stud Size: 1/2"

Push-On Bolt Retainer
15/16" O.D.

CL Part No: 910-1746, Pieces: 10

242-406

Std. Pkg. 100 pcs.

Stud Size : 1/8"

Push-On Retainer
3/8" O.D.

242-410

Std. Pkg. 100 pcs.

Stud Size : 3/16"

Push-On Retainer
7/16" O.D.



242-414 Std. Pkg. 100 pcs.
Stud Size: 1/4"
 Push-On Retainer
 17/32" O.D.



242-422 Std. Pkg. 100 pcs.
Stud Size: 1/2"
 Push-On Retainer
 1" O.D.



243-305 Std. Pkg. 100 pcs.
Stud Size: M5-0.8
 Push-On Bolt Retainer
 11 mm O.D.
 CL Part No: 910-1755, Pieces: 10



243-306 Std. Pkg. 100 pcs.
M6
 Push-On Bolt Retainer
 17mm O.D.
 CL Part No: 910-1756, Pieces: 10



243-307 Std. Pkg. 100 pcs.
M6.3
 Push-On Bolt Retainer
 14.3 mm O.D.

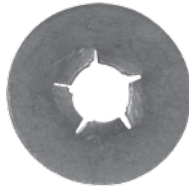

243-308 Std. Pkg. 100 pcs.
M8
 Push-On Bolt Retainer
 24mm O.D.
 CL Part No: 910-1757, Pieces: 8



243-310 Std. Pkg. 100 pcs.
M10
 Push-On Bolt Retainer
 24mm O.D.



243-312 Std. Pkg. 100 pcs.
M12
 Push-On Bolt Retainer
 21.4mm O.D.
 CL Part No: 910-1759, Pieces: 8

ASSORTED NUTS



244-952 Std. Pkg. 50 pcs.
M5-0.8
 Metric Free Spinning Washer Nuts Zinc & Yellow
 10 mm Washer O.D., Hex Size: 8mm, Height: 7mm
 #N802775-S36
 CL Part No: 910-0160, Pieces: 4



244-953 Std. Pkg. 25 pcs.
M5-0.8
 FORD
 Washer Nut
 15 mm Washer O.D., Hex Size: 10mm,
 Height: 7mm
 #N621903



244-955 Std. Pkg. 25 pcs.
M6-1.0
 CHRYSLER
 Washer Nut
 18 mm Washer O.D., Hex Size: 10mm, Height: 9mm
 #6100048
 CL Part No: 910-0130, Pieces: 4



244-956 Std. Pkg. 25 pcs.

M6-1.0

GM, FORD
Free Spinning Washer Nut
16 mm Washer O.D., Hex Size: 10mm, Height: 7mm
GM #11503752, 1150329, VW #N90100001

CL Part No: 910-0125, Pieces: 4

244-957 Std. Pkg. 25 pcs.

M6-1.0

Free Spinning Washer Nut
20 mm Washer O.D., Hex Size: 10mm,
Height: 9mm
#6100049

CL Part No: 910-0170, Pieces: 2

244-958 Std. Pkg. 25 pcs.

M6.3-1.0

GM
Free Spinning Washer Nut
16 mm Washer O.D., Hex Size: 11mm, Height: 9mm
#11500747, 11501106

CL Part No: 910-0175, Pieces: 3



244-959 Std. Pkg. 100 pcs.

M8-1.25

GM
Metric Spin Lock Nuts With Serrations
Case Hardened
19 mm Washer O.D., Hex Size: 13mm, Phosphate

CL Part No: 910-0180, Pieces: 4

244-970 Std. Pkg. 50 pcs.

M5-0.8

Metric Hex Flange Nut
11.5 mm Washer O.D., Hex Size: 8mm,
Height: 5mm, Black Ox.

CL Part No: 910-0120, Pieces: 3

244-985 Std. Pkg. 25 pcs.

M6-1.0

Metric Spin Lock Nuts With Serrations
Case Hardened
17 mm Washer O.D., Hex Size: 10mm, Phosphate

CL Part No: 910-0165, Pieces: 6



244-986 Std. Pkg. 25 pcs.

M6-1.0

GM
Metric Flange Nut Phosphate
14mm Washer O.D., Hex Size: 10mm, Height: 6mm
#11503745

244-987 Std. Pkg. 25 pcs.

M8-1.25

GM
Metric Flange Nut Phosphate
17mm Washer O.D., Hex Size: 13mm, Height: 8mm
#11501889

CL Part No: 910-0135, Pieces: 4

244-988 Std. Pkg. 25 pcs.

M10-1.5

GM
Metric Flange Nut Phosphate
21.5mm Washer O.D., Hex Size: 15mm, Height: 11.2mm
#11501850

CL Part No: 910-0150, Pieces: 3



244-997 Std. Pkg. 25 pcs.

M8-1.25

Metric Flanged Nut
24 mm Washer O.D., Hex Size: 13mm,
Height: 10.5mm, Phosphate
#11503695, 11506117, N621940

CL Part No: 910-0140, Pieces: 3

244-998 Std. Pkg. 25 pcs.

M10-1.25

Metric Flanged Nut
19 mm Washer O.D., Hex Size: 14mm,
Height: 10.5mm, Zinc

CL Part No: 910-0145, Pieces: 2



245-146

Std. Pkg. 25 pcs.

1/4"–20x3/4"

Round Head Type 1
Stainless Steel Capped Bumper Bar Bolt w/o Nuts
Head Diameter: 5/8", Shoulder Length: 9/64"

CL Part No: 910-1360, Pieces: 2

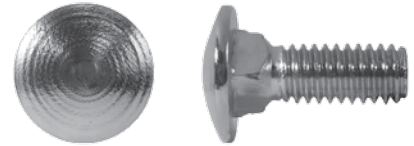

245-150

Std. Pkg. 25 pcs.

5/16"–18x7/8"

Round Head Type 1
Stainless Steel Capped Bumper Bar Bolt Round Polished w/o Nuts
Head Diameter: 11/16"

CL Part No: 910-1370, Pieces: 2



245-153

Std. Pkg. 12 pcs.

5/16–18x1"

Round Head Type 1
Stainless Steel Capped Bumper Bar Bolts w/Nuts

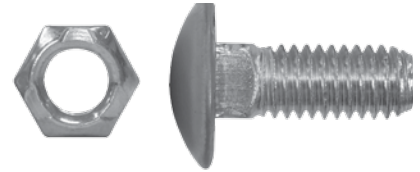

245-160

Std. Pkg. 12 pcs.

3/8–16x3/4"

Round Head Type 1
Stainless Steel Capped Bumper Bar Bolts w/Nuts



245-161

Std. Pkg. 12 pcs.

3/8–16x3/4"

Semi-Round Head Type 2
Stainless Steel Capped Bumper Bar Bolts w/Nuts

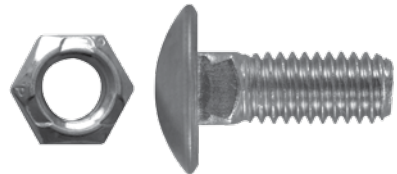

245-164

Std. Pkg. 12 pcs.

3/8–16x1"

Round Head Type 1
Stainless Steel Capped Bumper Bar Bolts W/Nuts

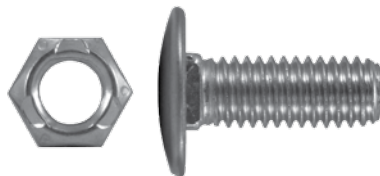

245-165

Std. Pkg. 12 pcs.

3/8–16x1"

Semi-Round Head Type 2
Stainless Steel Capped Bumper Bar Bolts w/Nuts



245-167

Std. Pkg. 12 pcs.

3/8–16x1–1/4"

Round Head Type 1
Stainless Steel Capped Bumper Bar Bolts W/Nuts



245-170

Std. Pkg. 12 pcs.

7/16–14x7/8"

Round Head Type 1
Stainless Steel Capped Bumper Bar Bolts W/Nuts

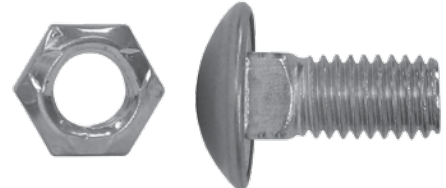

245-171

Std. Pkg. 12 pcs.

7/16–14x1"

Round Head Type 1
Stainless Steel Capped Bumper Bar Bolts W/Nuts

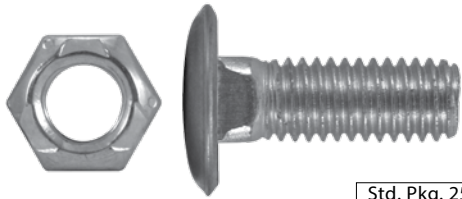

245-172

Std. Pkg. 25 pcs.

7/16-14x1-1/4"

Round Head Type 1

Stainless Steel Capped Bumper Bar Bolts w/Nuts

CL Part No: 910-1380, Pieces: 1

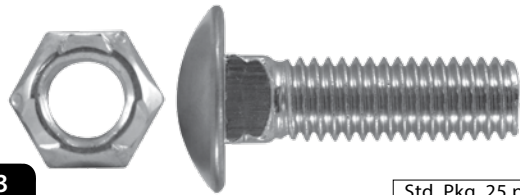

245-173

Std. Pkg. 25 pcs.

7/16-14x1-1/2"

Round Head Type 1

Stainless Steel Capped Bumper Bar Bolts w/Nuts

CL Part No: 910-1381, Pieces: 1



245-175

Std. Pkg. 12 pcs.

7/16-14x2

Round Head Type 1

Stainless Steel Capped Bumper Bar Bolts w/Nuts

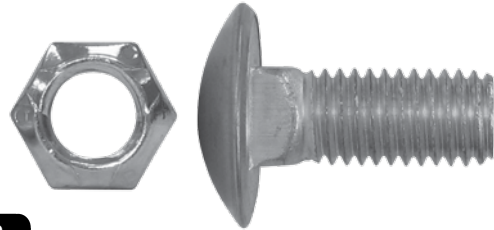

245-182

Std. Pkg. 12 pcs.

1/2-13x1-1/4

Round Head Type 1

Stainless Steel Capped Bumper Bar Bolts w/Nuts

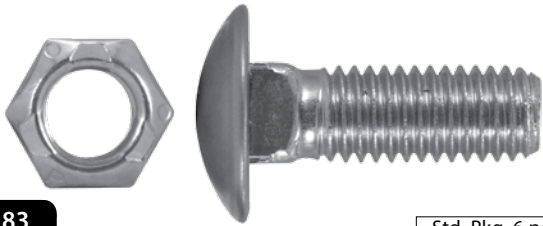

245-183

Std. Pkg. 6 pcs.

1/2-13x1-1/2"

Round Head Type 1

Stainless Steel Capped Bumper Bar Bolts w/Nuts

CL Part No: 910-1385, Pieces: 1



245-184

Std. Pkg. 12 pcs.

1/2-13x1-3/4

Round Head Type 1

Stainless Steel Capped Bumper Bar Bolts W/Nuts



245-185

Std. Pkg. 12 pcs.

1/2-13x2-1/4

Semi-Round Head Type 1

Stainless Steel Capped Bumper Bar Bolts w/Nuts

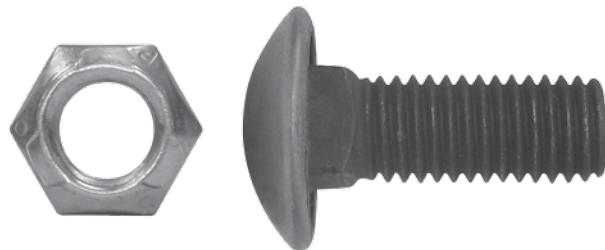

245-190

Std. Pkg. 12 pcs.

9/16-12x1-1/2

Semi-Round Head Type 1

Stainless Steel Capped Bumper Bar Bolts w/Nuts

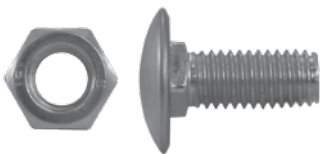

245-220

Std. Pkg. 10 pcs.

M8-1.25x25mm

Type 1: Chrome Plated Capped Bumper Bar Bolts W/Nuts

CL Part No: 910-1390, Pieces: 2



245-221

Std. Pkg. 10 pcs.

M8-1.25x30mm

Type 1: Uncapped Bumper Bar Bolts W/Nuts

BODY BOLTS**BUMPER BAR BOLTS**

17

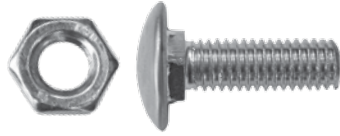
BOULONS DE CARROSSERIE**BOULONS DE PARE-CHOC**

245-222

Std. Pkg. 10 pcs.

M8-1.25x27mm

Type 2: Stainless Steel Capped
Bumper Bar Bolts W/Nuts

245-223

Std. Pkg. 10 pcs.

M8-1.25x27mm

Type 2: Uncapped
Bumper Bar Bolts W/Nuts

245-233

Std. Pkg. 10 pcs.

M10-1.5x33mm

Type 2: Stainless Steel Capped
Bumper Bar Bolts W/Nuts

245-238

Std. Pkg. 10 pcs.

M12-1.75x40mm

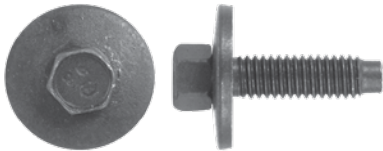
Type 2: Stainless Steel Capped
Bumper Bar Bolts W/Nuts**BODY BOLTS**

245-321

Std. Pkg. 25 pcs.

1/4-20x7/8"

FORD
Body Bolt Black Phosphate
Hex Head Sems® With Dog Point
3/4" Washer O.D., Hex Size: 7/16" - #57030-S2

245-614

Std. Pkg. 25 pcs.

5/16-18x13/16"

GM
Hex Washer Head Body Bolt Phosphate
41/64" Washer O.D., Hex Size: 1/2" - #3960314

245-615

Std. Pkg. 25 pcs.

5/16-18x7/8"

GM
Indented Hex Head Body Bolt Phosphate
3/4" Washer O.D., Hex Size: 1/2" - #3846202

245-616

Std. Pkg. 25 pcs.

5/16-18x1"

Indented Hex Head Body Bolt Phosphate
7/8" Washer O.D., Hex Size: 1/2"
Not Available through O.E.M.

245-620

Std. Pkg. 25 pcs.

3/8-16x1"

GM
Indented Hex Head Body Bolt Phosphate
1" Washer O.D., Hex Size: 9/16" - #3986997, 14011722

245-621

Std. Pkg. 25 pcs.

1/4-20x1"

CHRYSLER
Hex Head Sems® with Dog Point Body Bolt Phosphate
5/8" Washer O.D., Hex Size: 7/16" - #6025329

CL Part No: 910-0020, Pieces: 4

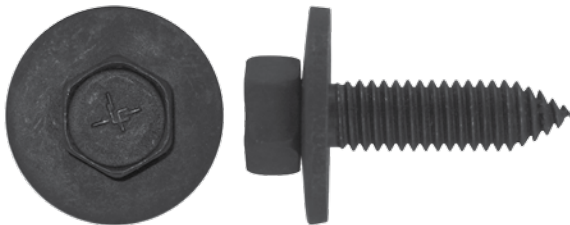

245-630

Std. Pkg. 25 pcs.

3/8-16x1-1/2"

GM: Indented Hex Head Body Bolt Phosphate
1-1/8" Washer O.D., Hex Size: 9/16" - #407217, 1564180

CL Part No: 910-0025, Pieces: 2



245-310

Std. Pkg. 50 pcs.

M4.2-1.41x20mm

GM: Body Bolt Phosphate Hex Head Sems® Body Bolt Phosphate
12mm Washer O.D., Hex Size: 7mm - #11504056, 11513801

CL Part No: 910-1285, Pieces: 6

All Images are Actual Size

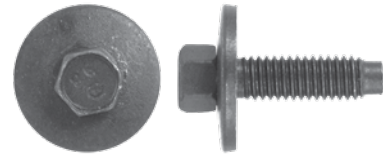
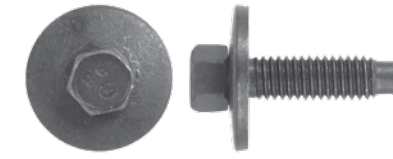

245-315 Std. Pkg. 25 pcs.
M6-1.0x28mm
 FORD
 Body Bolt Phosphate
 Hex Head Sems® With Dog Point
 19mm Washer O.D., Hex Size: 8mm
 #N606677-S43B
CL Part No: 910-0060, Pieces: 4

245-322 Std. Pkg. 25 pcs.
M6-1.0x22mm
 FORD
 Body Bolt Phosphate
 19mm Washer O.D., Hex Size: 8mm
 #N606676-S2, N606676-S100
CL Part No: 910-0046, Pieces: 4

245-323 Std. Pkg. 25 pcs.
M6-1.0x28mm
 FORD
 Hex Head Sems® With Dog Point
 19mm Washer O.D., Class 9.8, Hex Size: 8mm
 #N606677-S36
CL Part No: 910-0057, Pieces: 3

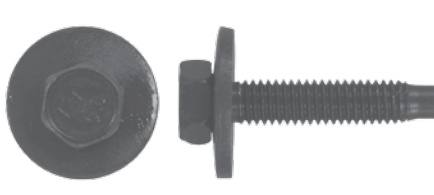
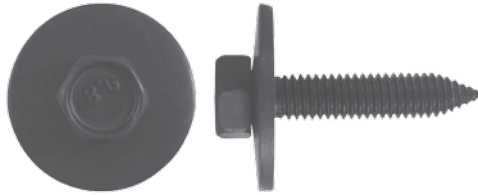

245-324 Std. Pkg. 25 pcs.
M6-1.0x30mm
 GM
 Hex Head Sems®
 24mm Washer O.D., Class 9.8, Hex Size: 10mm
 #11503825

245-325 Std. Pkg. 25 pcs.
M6-1.0x30mm
 CHRYSLER
 Body Bolt Phosphate
 19mm Washer O.D., Hex Size: 10mm
 #6100568

245-326 Std. Pkg. 50 pcs.
M5-0.8x20mm
 CHRYSLER
 Hex Head Sems® with Dog Point
 12mm Washer O.D., Hex Size: 8mm
 #6100539
CL Part No: 910-0035, Pieces: 5

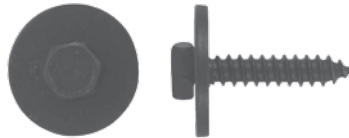

245-399 Std. Pkg. 25 pcs.
M4.2-1.41x20mm
 Hex Head Sems® With Teks® Point
 12mm Head O.D., Hex Size: 7mm
 Not Available through O.E.M.

245-400 Std. Pkg. 25 pcs.
M4.2-1.41x20mm
 GM
 Indented Hex Head Sems Phosphate
 16mm Washer O.D., Hex Size: 7mm
 #11500434, 11503892, 1640810
CL Part No: 910-0030, Pieces: 5

245-405 Std. Pkg. 25 pcs.
M6-1.0x20mm
 GM
 Body Bolt Phosphate
 17mm Washer O.D., Hex Size: 10mm
 #11502941, 11506174
CL Part No: 910-0043, Pieces: 3

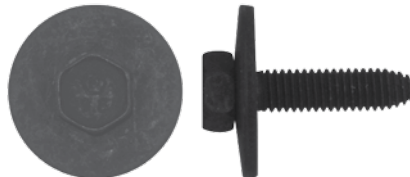
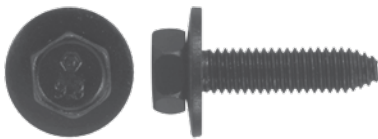

245-407 Std. Pkg. 25 pcs.
M6-1.0x25mm
 GM
 Body Bolt Phosphate
 17mm Washer O.D., Hex Size: 10mm
 #11503834, 20351035
CL Part No: 910-0050, Pieces: 5

245-408 Std. Pkg. 25 pcs.
M6-1.0x25mm
 GM
 Body Bolt Phosphate
 24mm Washer O.D., Hex Size: 10mm
 #11503982
CL Part No: 910-0053, Pieces: 4

245-420 Std. Pkg. 25 pcs.
M6.3-1.0x20mm
 GM
 Body Bolt Phosphate
 17mm Washer O.D., Hex Size: 10mm
 #11501105
CL Part No: 910-0070, Pieces: 4

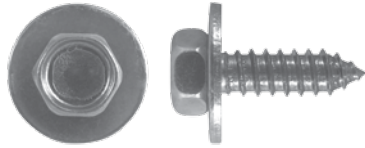

245-421 Std. Pkg. 25 pcs.
M6.3-1.81x20mm
 HONDA, NISSAN, TOYOTA
 Hex Head Sems®
 18mm Washer O.D., Hex Size: 10mm
 Not Available through O.E.M.

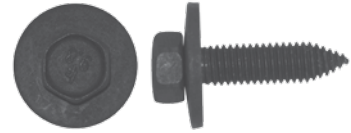

245-424 Std. Pkg. 25 pcs.
M6.3-1.0x25mm
 Body Bolt Phosphate
 18mm Washer O.D.
 #11500754

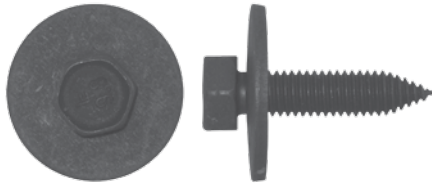

245-425 Std. Pkg. 25 pcs.
M6.3-1.0x25mm
 Body Bolt Phosphate
 24mm Washer O.D.
 #365718

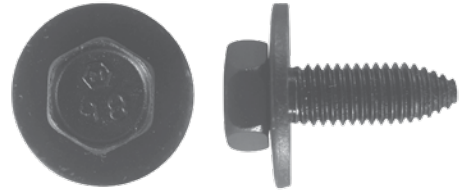

245-439 Std. Pkg. 25 pcs.
M8-1.25x25mm
 GM
 Hex Head Sems®
 24mm Washer O.D., Hex Size: 13mm
 #11503619

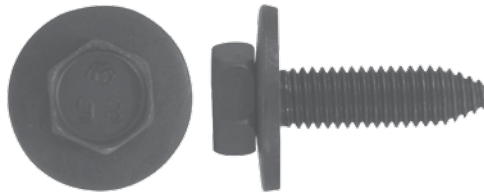

245-440 Std. Pkg. 25 pcs.
M8-1.25x30mm
 GM
 Body Bolt Phosphate
 24mm Washer O.D., Hex Size: 13mm
 #11501188
CL Part No: 910-0090, Pieces: 2



245-441 Std. Pkg. 25 pcs.
M8-1.25x30mm
 GM
 Body Bolt Phosphate
 17mm Washer O.D., Hex Size: 13mm
 #11500971
CL Part No: 910-0085, Pieces: 3

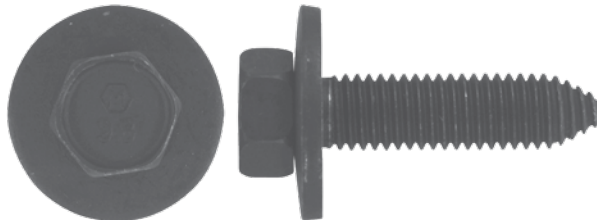

245-450 Std. Pkg. 15 pcs.
M10-1.5x40mm
 GM
 Body Bolt Phosphate
 29mm Washer O.D., Hex Size: 15mm
 #11501193
CL Part No: 910-0100, Pieces: 2



245-505 Std. Pkg. 25 pcs.
M6-1.0x20mm
 GM
 Indented Hex Head Body Bolt Phosphate
 13mm Washer O.D., Hex Size: 10mm
 #11503800
CL Part No: 910-0040, Pieces: 4

BOULONS DE CARROSSERIE

BOULONS DIVERS

ÉCROUS POUR PLAQUES D'IMMATRICULATION



245-507

Std. Pkg. 25 pcs.

M6-1.0x25mm

GM

Indented Hex Head Body Bolt Phosphate
13mm Washer O.D., Hex Size: 10mm
#11503958



245-510

Std. Pkg. 25 pcs.

M6-1.0x35mm

GM

Indented Hex Head Body Bolt Phosphate
17mm Washer O.D., Hex Size: 10mm
#11505044

CL Part No: 910-0065, Pieces: 3



245-525

Std. Pkg. 25 pcs.

M8-1.25x25mm

GM

Indented Hex Head Body Bolt Phosphate
17mm Washer O.D., Hex Size: 13mm
#11503632

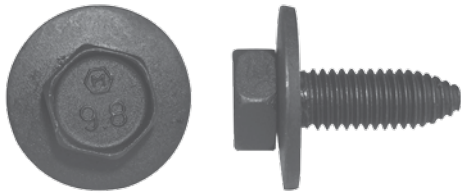

245-526

Std. Pkg. 25 pcs.

M8-1.25x25mm

GM

Hex Head Sems® Body Bolt Phosphate
24mm Washer O.D., Hex Size: 13mm
#11503619

CL Part No: 910-0075, Pieces: 2



245-527

Std. Pkg. 25 pcs.

M8-1.25x30mm

GM

Indented Hex Head Body Bolt Phosphate
17mm Washer O.D., Hex Size: 13mm
#11500971

CL Part No: 910-0080, Pieces: 2

MISC. BOLTS



245-610

Std. Pkg. 25 pcs.

1/4-20x1-1/4 S/S

CHRYSLER, GM

Stainless Mirror Mounting Bolt
5/8" Washer O.D., Hex Size: 3/8"
** Use with 239-960**

#14007511, 367291, 474821

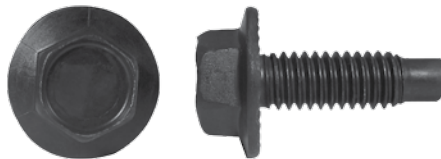

245-617

Std. Pkg. 25 pcs.

5/16-18x1"

Hex Washer Head Spin Lock Bolts
13/16" Washer O.D., Hex Size: 1/2"

CL Part No: 910-0015, Pieces: 3

LICENCE PLATE NUTS



240-800

Std. Pkg. 100 pcs.

Screw Size: No. 8

CHRYSLER

License Plate Nut & Headlight
Door Mounting Screw Nut

CL Part No: 910-2010, Pieces: 10



240-841

Std. Pkg. 50 pcs.

Screw Size: No.1/4-20

GM

License Plate Nut
#1196781

CL Part No: 910-2070, Pieces: 6



240-842

Std. Pkg. 50 pcs.

Screw Size: No.14

GM

License Plate Nut
#380370

CL Part No: 910-2080, Pieces: 4

LICENCE PLATE NUTS



247-840 Std. Pkg. 25 pcs.
Screw Size: No.14
 GM
 License Plate Nut
 #3907444, 4755299
CL Part No: 910-2075, Pieces: 5

BOLT AND NUT ASSEMBLY

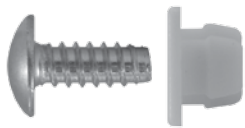

245-906 Std. Pkg. 50 pcs.
14x5/8"
 Licence Plate Bolt and #14 Square Nylon Nut
****Made of two parts 247-840 & 245-910****
CL Part No: 910-2085, Pieces: 4



245-909 Std. Pkg. 100 pcs.
1/4-20x1/2"
 Nylon Licence Plate Bolt and Nut Assembly
 Not Available through O.E.M.

'T' BOLT CLIPS



246-112 Std. Pkg. 50 pcs.
10-24x3/4"
 CHRYSLER
 Universal 'T' Bolt Clip
 Plate Length: 3/4", Plate Width: 5/16"
 #1624705, 6010093
CL Part No: 910-1676, Pieces: 2



246-120 Std. Pkg. 50 pcs.
10-24x1/2"
 Universal 'T' Bolt Clip



246-122 Std. Pkg. 50 pcs.
10-24x3/4"
 GM, CHRYSLER
 Universal 'T' Bolt Clip
 Plate Length: 1-25/32", Plate Width: 9/16"
 GM #3744999; CHRY #1758099, 6000720, 6010046
CL Part No: 910-1670, Pieces: 2



246-124 Std. Pkg. 50 pcs.
10-24x3/4"
 GM, CHRYSLER
 Universal 'T' Bolt Clip
 Plate Length: 1-11/32", Plate Width: 1/2"
 GM #3722635; CHRY #6000705, 6013029
CL Part No: 910-1675, Pieces: 2



230-616

Std. Pkg. 50 pcs.

M6-1.0x20mm

CHRYSLER, HONDA & AMC
Slotted Hex Washer Head Licence Plate Screw
13mm Washer O.D., Hex Size: 10mm, Zinc
CHRY #34201287; AMC #8934201287

CL Part No: 910-1190, Pieces: 4

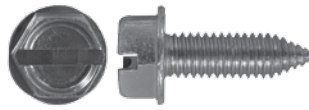

245-613

Std. Pkg. 50 pcs.

M6-1.0x20mm

CHRYSLER, FORD, AMC
Slotted Hex Washer Head Licence Plate Screw
13mm Washer O.D., Hex Size: 10mm, Zinc
CHRY #34201287, AMC #8934201287



245-900

Std. Pkg. 25 pcs.

14x3/4"

FORD
Slotted Hex Washer Head Licence Plate Screw
1/2" Washer O.D., Hex Size: 3/8"
Not Available through O.E.M.



245-903

Std. Pkg. 100 pcs.

14x5/8"

FORD
Slotted Hex Washer Head Licence Plate Screw
5/8" Washer O.D., Hex Size: 5/16"
#N800369-S2

CL Part No: 910-0005, Pieces: 4



245-911

Std. Pkg. 25 pcs.

M6-1.81x20mm

HONDA 1990-on, TOYOTA
Phillips Hex Washer Head Licence Plate Screw
Head O.D., Hex Size: 10mm
TOYOTA #93904-46320,
HONDA #91500-SM4-999AH

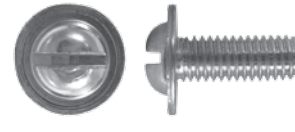

245-912

Std. Pkg. 25 pcs.

M6-1.0x16mm

Slotted Round Washer Head Licence Plate Screw
Head O.D. 14mm



245-914

Std. Pkg. 100 pcs.

14x3/4"

Slotted Truss Head Licence Plate Screw
9/16" Head Dia.

CL Part No: 910-1185, Pieces: 8



245-915

Std. Pkg. 50 pcs.

14x3/4"

FORD
Slotted Hex Washer Head Licence Plate Screw
1/2" Washer O.D., Hex Size: 3/8"

CL Part No: 910-1100, Pieces: 4



246-212 Std. Pkg. 25 pcs.

Moulding Fastener

GM
Moulding Fastener, Universal
#3944866, 1244839

CL Part No: 910-1680, Pieces: 2

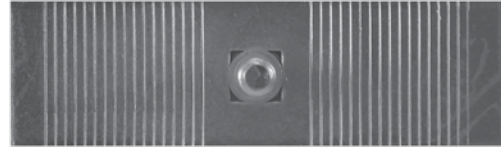

246-400 Std. Pkg. 25 pcs.

10-24x3/4"

Scored Type Moulding Bolt
Fits Up To 2-1/2" Wide



246-411 Std. Pkg. 25 pcs.

Rear Window Reveal Moulding Clip

GM 1969-on
Rear Window Reveal Moulding Clip
#8717859, 9854717

CL Part No: 910-1325, Pieces: 4



246-413 Std. Pkg. 25 pcs.

Windshield & Backlite Moulding Clip

CHRYSLER 1974-on
Windshield & Backlite Reveal Moulding Clip
#6003409, 6003752

CL Part No: 910-1350, Pieces: 6



246-415 Std. Pkg. 25 pcs.

Windshield & Backlite Moulding Clip

FORD 1983-on
Windshield & Backlite Reveal Moulding Clip
#E3SB-6342413-AB



246-417 Std. Pkg. 25 pcs.

Windshield and Rear Window Reveal Moulding Clip

GM 1973-on
Windshield & Rear Window
Reveal Moulding Clip
#9662950, 9606232, 20603072



246-418 Std. Pkg. 25 pcs.

Windshield to Panel Side (Lower)

GM 1975-on, AMC 1975-on
Windshield to Panel Side (Lower)
GM #9731301, AMC #4005540

CL Part No: 910-1330, Pieces: 6



246-425 Std. Pkg. 25 pcs.

Door Lock Rod Clip

GM 1964-on
Door Lock Rod Clip
#4234830, 12337868

CL Part No: 910-1345, Pieces: 4

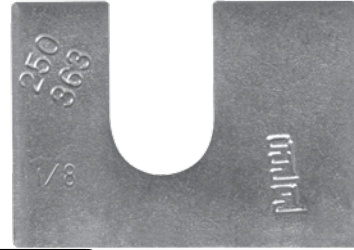

250-082 Std. Pkg. 25 pcs.
 1-3/16"x1-1/8"
 GM 1971-up
 Body Shim
 1/2" Slot, 1/16" Thick
 CL Part No: 910-1715, Pieces: 5

250-083 Std. Pkg. 25 pcs.
 1-1/8"x1-1/8"
 FORD
 Body Shim
 1/2" Slot, 1/8" Thick
 CL Part No: 910-1720, Pieces: 4

250-363 Std. Pkg. 25 pcs.
 1-1/4"x1-3/4"
 Body Shim
 1/2" Slot, 1/8" Thick
 CL Part No: 910-1725, Pieces: 4



250-371 Std. Pkg. 25 pcs.
 1-1/8"x1-5/16"
 Hood Shim
 3/8" Slot, 1/16" Thick
 CL Part No: 910-1710, Pieces: 7

250-372 Std. Pkg. 25 pcs.
 1-1/8"x1-5/16"
 Hood Shim
 3/8" Slot, 1/8" Thick
 CL Part No: 910-1711, Pieces: 6

METAL PLUGS

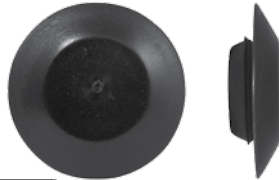
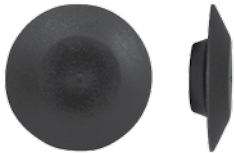

314-314 Std. Pkg. 100 pcs.
 3/8
 Flush Sheet Metal Plug
 Head Dia. 3/4"
 CL Part No: 910-1300, Pieces: 10

314-316 Std. Pkg. 100 pcs.
 1/2
 Flush Sheet Metal Plug
 Head Dia. 7/8"
 CL Part No: 910-1302, Pieces: 10

314-322 Std. Pkg. 100 pcs.
 1/2
 Plastic Plug Button
 Head Dia. 7/8"
 CL Part No: 910-1305, Pieces: 10



314-326 Std. Pkg. 100 pcs.
 3/8
 Plastic Plug Button
 Head Dia. 1-5/32"
 CL Part No: 910-1306, Pieces: 6

AMC
CHRYSLER

INTERIOR RETAINERS

FORD
GM

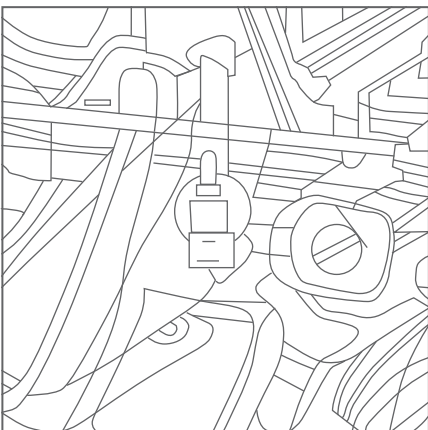
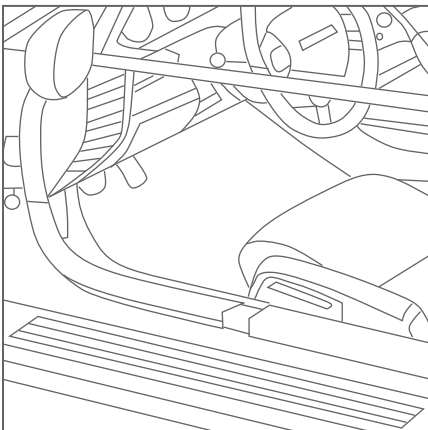
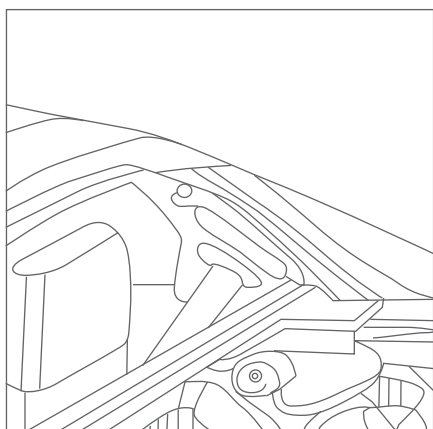
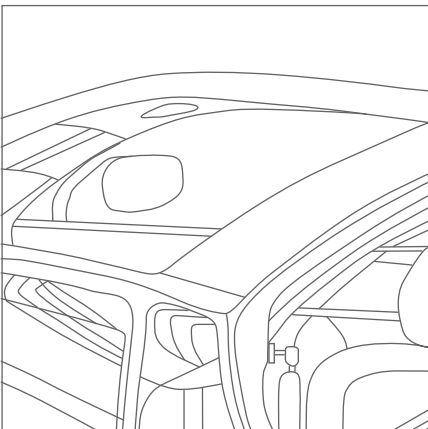

DOMESTIC
DOMESTIQUES

ATTACHES DE SOUTIEN INTERIEUR

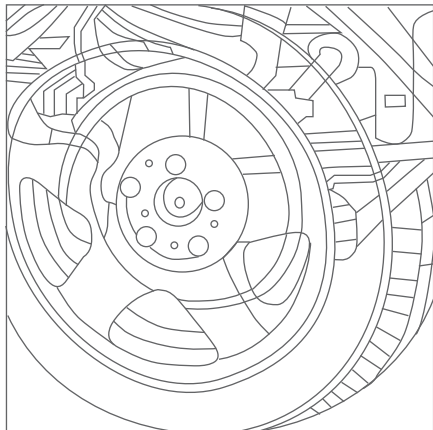

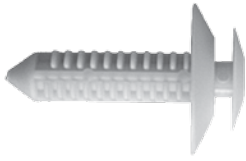

247-052

Std. Pkg. 25 pcs.

White Nylon Trim Panel Retainer

AMC
White Nylon Trim Panel Retainer
#8934-202-599



247-100

Std. Pkg. 25 pcs.

Door Trim Panel Retainer

AMC 1976-on
Door Trim Panel Retainer
#4005470

CL Part No: 910-0420, Pieces: 3

INTERIOR RETAINERS

CHRYSLER

ATTACHES DE SOUTEIN INTERIEUR

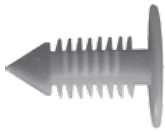

247-020

Std. Pkg. 25 pcs.

Roof Headliner Retainer

CHRYSLER 1982-on
Roof Headliner Retainer
#6003587

CL Part No: 910-0240, Pieces: 4



247-025

Std. Pkg. 25 pcs.

Black Nylon Door Trim Panel Retainer

CHRYSLER 1975-on
Black Nylon Door Trim Panel Retainer
#6003349, 6032363

CL Part No: 910-0230, Pieces: 3

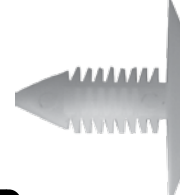

247-026

Std. Pkg. 25 pcs.

Interior Trim Panel Retainer

CHRYSLER 1977-on
Interior Trim Panel Retainer
#6003423

CL Part No: 910-0235, Pieces: 5



247-050

Std. Pkg. 25 pcs.

Interior Trim Panel Retainer

CHRYSLER 1976-on
Interior Trim Panel Retainer
#6013122

CL Part No: 910-0415, Pieces: 3



247-098

Std. Pkg. 25 pcs.

Interior Trim Panel Retainer

CHRYSLER Mini Vans 1987-on
Interior Trim Panel Retainer
#6501301

247-100

Std. Pkg. 25 pcs.

Door Trim Panel Retainer

CHRYSLER 1976-on
Door Trim Panel Retainer
#6003349

CL Part No: 910-0420, Pieces: 3

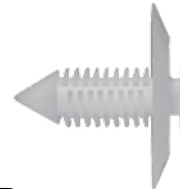

247-101

Std. Pkg. 25 pcs.

Door Trim Panel Retainer

CHRYSLER 1974-on
Trim Panel Retainer
#6003368

CL Part No: 910-0425, Pieces: 2



247-104

Std. Pkg. 25 pcs.

Door Trim Panel Retainer

CHRYSLER Vans 1998-on
Door Trim Panel Retainer
#6505292AA

CL Part No: 910-0485, Pieces: 3



247-109

Std. Pkg. 25 pcs.

Door Trim Panel Retainer

CHRYSLER 2001-on
Door Trim Panel Retainer
Not Available through O.E.M.



247-113

Std. Pkg. 25 pcs.

Door Trim Panel Retainer

CHRYSLER Concorde, Intrepid,
LHS & 300M 1998-on
Door Trim Panel Retainer
#6505534-AA



247-136

Std. Pkg. 25 pcs.

Trim Panel Fastener

CHRYSLER
Trim Panel Fastener
Fits into 5/16" Hole
#4114785



247-149

Std. Pkg. 25 pcs.

Door Trim Panel Fastener

CHRYSLER
Door Trim Panel Fastener
#1900654

CL Part No: 910-0935, Pieces: 4



247-151

Std. Pkg. 25 pcs.

Weatherstrip Retainer

CHRYSLER Concorde & LHS
Dodge Interid & Eagle Vision 1993-on
Weatherstrip Retainer
#4696129

CL Part No: 910-0885, Pieces: 6



247-152

Std. Pkg. 25 pcs.

Weatherstrip Retainer

CHRYSLER 1997-on
Weatherstrip Retainer
Not Available through O.E.M.



247-153

Std. Pkg. 25 pcs.

Weatherstrip Retainer

CHRYSLER 2005-on
Weatherstrip Retainer
Not Available through O.E.M.



247-160

Std. Pkg. 25 pcs.

Weatherstrip Retainer

CHRYSLER 1977-on
Weatherstrip Retainer
#2964547

CL Part No: 910-0220, Pieces: 3



247-214

Std. Pkg. 25 pcs.

Black Nylon Trim Panel Retainer

Truck Lid Latch CHRYSLER 1996-on
Black Nylon Trim Panel Retainer
#6504043

CL Part No: 910-0350, Pieces: 4



247-219

Std. Pkg. 25 pcs.

Black Nylon Trim Panel Retainer

CHRYSLER
Black Nylon Trim Panel Retainer
#6503943



247-025

Std. Pkg. 25 pcs.

Black Nylon Door Trim Panel Retainer

FORD 1975-on
Black Nylon Door Trim Panel Retainer
#385661-S

CL Part No: 910-0230, Pieces: 3



247-035

Std. Pkg. 25 pcs.

Dashboard Retainer

FORD 1979-on
Dashboard Retainer
#N-800387-S



247-038

Std. Pkg. 25 pcs.

Trim Panel Retainer

FORD 1980-on
Trim Panel Retainer
#388930-S

CL Part No: 910-0275, Pieces: 4

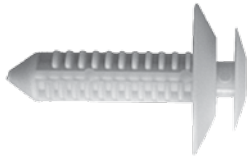

247-052

Std. Pkg. 25 pcs.

White Nylon Trim Panel Retainer

FORD Tempo & Topaz 1988-on
White Nylon Trim Panel Retainer
#N805612-S100



247-053

Std. Pkg. 25 pcs.

Trim Panel Retainer

FORD 1985-on
Trim Panel Retainer
#N805155-S

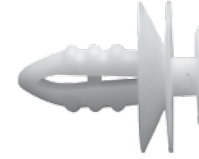

247-055

Std. Pkg. 25 pcs.

Interior Trim Panel Retainer

FORD 1977-on
Interior Trim Panel Retainer
#387477-S

CL Part No: 910-0435, Pieces: 4



247-062

Std. Pkg. 25 pcs.

Door Trim Panel Retainer

FORD 1981-on
Door Trim Panel Retainer
#N801925-S

CL Part No: 910-0440, Pieces: 3



247-065

Std. Pkg. 25 pcs.

Seat Back Panel Retainer

FORD 1977-on
Seat Back Panel Retainer
#387182-S

CL Part No: 910-0405, Pieces: 3



247-087

Std. Pkg. 25 pcs.

Head Dia: 19mm, Stem Length: 20mm

FORD
Black Nylon Trim Panel Retainer
Fits into 8mm Hole
#6998849



247-093

Std. Pkg. 25 pcs.

Door Trim Panel Retainer

FORD
Door Trim Panel Retainer
#N802900



247-106

Std. Pkg. 25 pcs.

Trim Panel Retainer

FORD Taurus & Sable 2000-on
Trim Panel Retainer
#W708621-S300



247-108

Std. Pkg. 25 pcs.

Top Head Dia: 15mm, Bottom Head Dia: 20mm

FORD 2001-on
Door Trim Panel Push-Type Retainer
Overall Length: 32mm, Fits into 9mm Hole
Not Available through O.E.M.

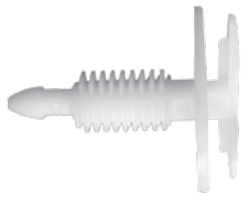

247-110

Std. Pkg. 25 pcs.

Trim Panel Retainer

FORD 1976-on
Trim Panel Retainer
#387496-S

CL Part No: 910-0410, Pieces: 3



247-149

Std. Pkg. 25 pcs.

Door Trim Panel Fastener

FORD
Door Trim Panel Fastener
#383033-S101, 358470

CL Part No: 910-0935, Pieces: 4



247-154

Std. Pkg. 25 pcs.

Weatherstrip Retainer

FORD 2004-on
Weatherstrip Retainer
Not Available through O.E.M.



247-165

Std. Pkg. 25 pcs.

Weatherstrip Retainer

FORD
Door Weatherstrip Retainer
#C5AB-6220586A

CL Part No: 910-0200, Pieces: 4



247-214

Std. Pkg. 25 pcs.

Black Nylon Trim Panel Retainer

FORD Explorer 1993-on
Black Nylon Trim Panel Retainer
#N807721-S

CL Part No: 910-0350, Pieces: 4



247-218

Std. Pkg. 25 pcs.

Black Nylon Grille & Shroud Retainer

FORD Explorer & Mountaineer 2003-on
Black Nylon Grille & Shroud Retainer
Not Available through O.E.M.



247-219

Std. Pkg. 25 pcs.

Black Nylon Trim Panel Retainer

FORD and Pontiac Grand Prix 1995-on
Black Nylon Trim Panel Retainer
#N806113-S



247-447

Std. Pkg. 25 pcs.

Splash Shield Retainer

FORD
Splash Shield, Seat Cushion & Spare Tire Retainer
Head Dia. 1", Stem L. 7/8", Fits into 5/16" Hole
#N804614-S

CL Part No: 910-0555, Pieces: 2



247-884

Std. Pkg. 25 pcs.

Trim Panel Retainer

FORD
Trim Panel Retainer
#N803387

CL Part No: 910-0325, Pieces: 2



247-010

Std. Pkg. 25 pcs.

Trim Panel Retainer

GM 1968-on
Trim Panel Retainer
#411700

CL Part No: 910-0255, Pieces: 5



247-012

Std. Pkg. 25 pcs.

Trim Panel Retainer

GM Truck 1976-on
Trim Panel Retainer
#15545202, 15612948, 15607165, 15953247

CL Part No: 910-0470, Pieces: 6

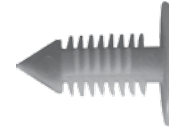

247-020

Std. Pkg. 25 pcs.

Roof Headliner Retainer

GM 1982-on
Roof Headliner Retainer
#25514221

CL Part No: 910-0240, Pieces: 4

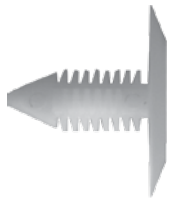

247-026

Std. Pkg. 25 pcs.

Interior Trim Panel Retainer

GM 1977-on
Interior Trim Panel Retainer
#2048248

CL Part No: 910-0235, Pieces: 5

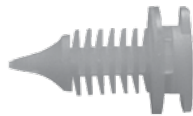

247-050

Std. Pkg. 25 pcs.

Trim Panel Retainer

GM 1982-on
Trim Panel Retainer
#20298365

CL Part No: 910-0415, Pieces: 3



247-052

Std. Pkg. 25 pcs.

White Nylon Trim Panel Retainer

GM Pontiac 1988-on
White Nylon Trim Panel Retainer
#10143422

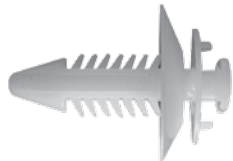

247-061

Std. Pkg. 25 pcs.

Door Trim Panel Retainer

GM 1983-on
Door Trim Panel Retainer
#10073833, 15600382, 20421800

CL Part No: 910-0450, Pieces: 5



247-068

Std. Pkg. 25 pcs.

Black Nylon Trim Panel Retainer

GM
Black Nylon Trim Panel Retainer
#95005064

CL Part No: 910-0455, Pieces: 3

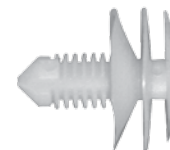

247-080

Std. Pkg. 25 pcs.

Door Trim Panel / Headliner Retainer

GM 1971-on
Door Trim Panel / Headliner Retainer
#2064891, 9818648, 9883583

CL Part No: 910-0400, Pieces: 5



247-082

Std. Pkg. 25 pcs.

Trim Panel Retainer

GM 1987-on
Trim Panel Retainer
#10126901

CL Part No: 910-0465, Pieces: 3

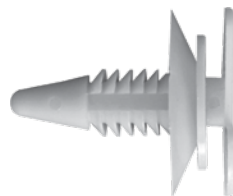

247-085

Std. Pkg. 25 pcs.

Door Trim Panel Retainer

GM 1978-on
Door Trim Panel Retainer
#3065575

CL Part No: 910-0430, Pieces: 4



247-091

Std. Pkg. 25 pcs.

Stem Dia. 9.5mm, Stem Length: 10mm

GM Chevrolet 2004-on
Yellow Nylon Trim Panel Retainer
Top Head Dia. 13mm, Middle Head Dia. 16mm,
Bottom Head Dia. 16mm
#94530565

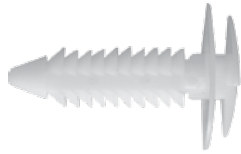

247-095 Std. Pkg. 25 pcs.
Trim Panel Retainer
 Chevy Truck GMC 1976-on
 Trim Panel Retainer
 #363137
CL Part No: 910-0460, Pieces: 2



247-097 Std. Pkg. 25 pcs.
Door Panel Retainer
 Camaro & Firebird 1982-on, GM Truck 1989-on
 Door Panel Retainer
 #12337920, 20374473
CL Part No: 910-0445, Pieces: 4



247-098 Std. Pkg. 25 pcs.
Trim Panel Retainer
 GM Saturn 1991-on
 Trim Panel Retainer
 #21094146



247-100 Std. Pkg. 25 pcs.
Door Trim Panel Retainer
 GM 1976-on
 Door Trim Panel Retainer
 #9685057
CL Part No: 910-0420, Pieces: 3



247-102 Std. Pkg. 25 pcs.
Head Dia 9/16", Stem Length 41/64"
 GM Trucks C, K, 1, 2, 3 1995-on
 Door Trim Panel Push Type Retainer
 Fits into 1/4" Hole
 #15960325
CL Part No: 910-0830, Pieces: 3

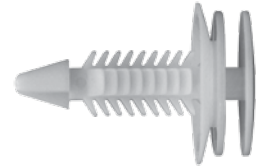

247-103 Std. Pkg. 25 pcs.
Trim Panel Retainer
 GM Truck, Express/Savana, Olds Silhouette &
 Pontiac Trans Sport 1997-on
 Buick Century & Regal Chevrolet Venture
 Trim Panel Retainer
 #10285935
CL Part No: 910-0480, Pieces: 5

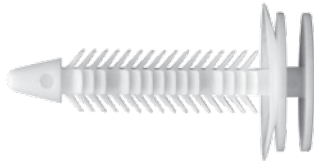

247-107 Std. Pkg. 25 pcs.
Door Trim Panel Retainer
 GM 1997-on
 Door Trim Panel Retainer
 #10421018



247-150 Std. Pkg. 25 pcs.
Door Weatherstrip Retainer
 GM 1963-on
 Door Weatherstrip Retainer
 #8731909



247-151 Std. Pkg. 25 pcs.
Weatherstrip Retainer
 Oldsmobile Alero & Pontiac Grand Am 1999-on
 Weatherstrip Retainer
 #21077575
CL Part No: 910-0885, Pieces: 6



247-155 Std. Pkg. 25 pcs.
Weatherstrip Retainer
 GM
 Weatherstrip Retainer
 #4876498
CL Part No: 910-0210, Pieces: 8



247-210 Std. Pkg. 25 pcs.
Black Nylon Weatherstrip Fastener
 GM 1977-on
 Black Nylon Weatherstrip Fastener
 #25016383
CL Part No: 910-0250, Pieces: 4



247-219 Std. Pkg. 25 pcs.
Black Nylon Trim Panel Retainer
 GM Cadillac Concours, DeVille & Seville,
 Chevrolet Impala, Lumina & Monte Carlo,
 Dodge Ram & Dakota
 Black Nylon Trim Panel Retainer
 #16674629

**247-602**

Std. Pkg. 25 pcs.

Door Trim Panel Retainer

Pontiac Vibe 2003-on
Door Trim Panel Retainer
#88970656

247-882

Std. Pkg. 25 pcs.

Seat Back Retainer

GM Camaro & Firebird 1982-on
Seat Back Retainer
#20319841

BMW
HONDA
HYUNDAI
ISUZU
KIA
LEXUS

INTERIOR RETAINERS

MAZDA
MERCEDES-BENZ
MITSUBISHI
NISSAN
TOYOTA
VW

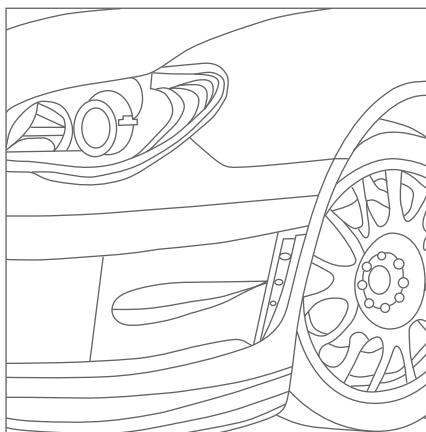
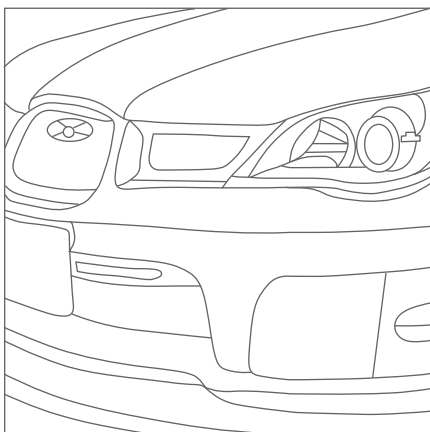
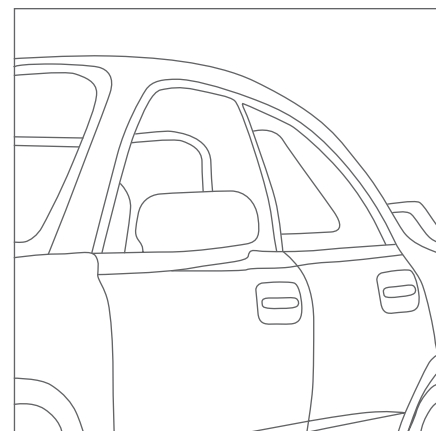
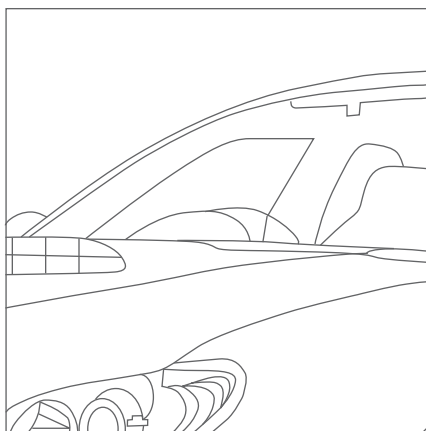

IMPORTS

IMPORTEES

ATTACHES DE SOUTIEN INTERIEUR

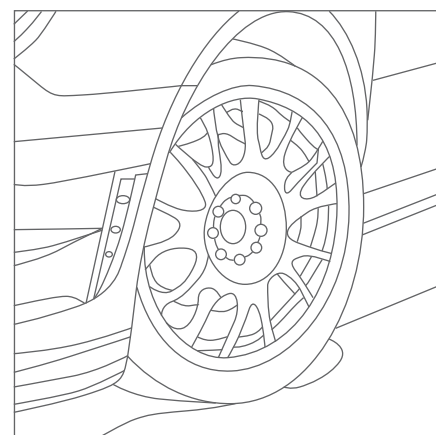



247-079

Std. Pkg. 25 pcs.

Top Head Dia. 14mm, Middle Head Dia. 15mm

BMW Series 3, 5, & 7 1987-on
White Nylon Trim Panel Retainer
Bottom Head Dia. 18mm, Stem Dia. 9mm
Stem Length: 15mm
#51-41-1-973-500



247-087

Std. Pkg. 25 pcs.

Head Dia. 19mm, Stem Length: 20mm

BMW
Black Nylon Trim Panel Retainer
Fits into 8mm Hole
#51-47-1-904-317



247-112

Std. Pkg. 25 pcs.

Head Dia. 20mm, Stem Length: 15mm

BMW Series 3, 5, 7 & X5 1989-on
Black Nylon Bumper, Wheel Opening,
Scuff Plate & Interior Trim Push-Type Retainer
Fits into 6.3mm Hole
#51-11-1-944-537



247-859

Std. Pkg. 25 pcs.

Nylon Plastic Nut

BMW
Nylon Plastic Nut
4mm Thread
#4133-5-480-120



247-862

Std. Pkg. 25 pcs.

Head Dia. 13mm, Stem Length: 11mm

BMW Series 3 & 5 1989-on
Cowl Panel Moulding Insert
Stem Dia. 9mm
#51-13-8-124-389
****Use with #247-440****

INTERIOR RETAINERS

HONDA

ATTACHES DE SOUTEIN INTÉRIEUR



245-218

Std. Pkg. 25 pcs.

Black Nylon Trim Panel Retainer

HONDA
Black Nylon Trim Panel Retainer
#90667-5A7-0030

CL Part No: 910-0330, Pieces: 3



245-219

Std. Pkg. 25 pcs.

Black Nylon Trim Panel Retainer

HONDA
Black Nylon Trim Panel Retainer
#90667-5AO-0030

CL Part No: 910-0335, Pieces: 3



247-073

Std. Pkg. 25 pcs.

Head Dia. 18mm, Stem Length: 15mm

HONDA
Retaining Clip
Snap into 7mm Hole, Panel thickness: 4mm
#38529-689A-6300



247-077

Std. Pkg. 25 pcs.

7mm Wide, 16mm Long, Stem Length: 10mm

HONDA
Weatherstrip Retainer
Fits into 5mm Hole
#90664-671-0030

CL Part No: 910-0290, Pieces: 4



247-083

Std. Pkg. 25 pcs.

Head Dia. 16mm, Stem Length: 16mm

HONDA
Trim Panel Retaining Clip
Stem Dia. 7mm
#90667-671-013ZA



247-437

Std. Pkg. 25 pcs.

Head Dia. 18mm, Stem Dia. 7mm x 7mm

HONDA Accord 2010
Trunk Lid & Interior Trim Retainer
Stem Length: 13mm
#90671-50D-003ZK



247-484 Std. Pkg. 25 pcs.
Head Dia. 17mm, Stem Length: 9mm
 HONDA 1990-on
 Push Type Retainer
 Fits into 8mm Hole
 #91508-SR3-000
CL Part No: 910-0760, Pieces: 1



247-850 Std. Pkg. 25 pcs.
Screw Size: No. 6
 HONDA
 Screw Grommet
 Head Dia. 14mm, Stem Length: 15mm
 Fits into 7mm x 7mm Hole
 #90672-671-8110M1
CL Part No: 910-1908, Pieces: 2



247-851 Std. Pkg. 25 pcs.
Screw Size: No. 8 (M4.2)
 HONDA
 Screw Grommet
 Head Dia. 16mm, Stem Length: 17mm
 Fits into 8mm x 8mm Hole
 #90661-SC7-0030



247-853 Std. Pkg. 25 pcs.
Screw Size: No. 6
 HONDA
 Screw Grommet
 Head Dia. 14mm, Stem Length: 10mm
 Fits into 7mm x 7mm Hole
 #90662-693-0030



247-854 Std. Pkg. 25 pcs.
Screw Size: No. 6
 HONDA
 Screw Grommet
 9.5mm Wide, 9.5mm Long
 Snaps into 6mm x 6mm Hole
 #90655-SA0-0030



247-856 Std. Pkg. 25 pcs.
Screw Size: No. 10
 HONDA
 Screw Grommet
 17mm Wide, 17 mm Long
 Snaps into 8mm x 8.5mm Hole
CL Part No: 910-1945, Pieces: 6



247-857 Std. Pkg. 25 pcs.
Screw Size: No. 6
 HONDA
 Screw Grommet with Sealer
 11mm Wide, 14mm Long, Stem Length: 10mm
 Snaps into 7mmx10mm Hole
 #90668-688-0030



247-872 Std. Pkg. 25 pcs.
Head Dia. 12.6mm, Stem Length: 14mm
 HONDA 1990-on
 White Nylon Door Trim Panel Retainer
 Fits into 9mm Hole
 #91566-SP0-003
CL Part No: 910-0475, Pieces: 2



247-876 Std. Pkg. 25 pcs.
Door Panel Retainer
 Acura TL & TSX and HONDA Accord, Civic,
 CRV & Odyssey 2002-on
 Door Panel Retainer
 #91560-S9A-A01



247-091

Std. Pkg. 25 pcs.

Stem Dia. 9.5mm, Stem Length: 10mm

HYUNDAI Accent, Santa Fe, Sonata
Tiburon & XG300/350 1999-on
Yellow Nylon Trim Panel Retainer
Top Head Dia. 13mm, Middle Head Dia. 16mm,
Bottom Head Dia. 16mm
#82315-38000

247-430

Std. Pkg. 15 pcs.

Stem Dia. 10mm, Stem Length: 12mm

HYUNDAI Azera, Elantra, Genesis, Santa Fe,
Sonata, Tiburon, Tucson & Veracruz
Pink Nylon Trim Panel Retainer
Top Head Dia. 15mm, Middle Head Dia. 16mm,
Bottom Head Dia. 18mm
#82315-27000

INTERIOR RETAINERS

KIA

ATTACHES DE SOUTEIN INTÉRIEUR



247-091

Std. Pkg. 25 pcs.

Stem Dia. 9.5mm, Stem Length: 10mm

KIA 2001-on
Yellow Nylon Trim Panel Retainer
Top Head Dia. 13mm, Middle Head Dia. 16mm,
Bottom Head Dia. 16mm
Not Available through O.E.M.

247-430

Std. Pkg. 15 pcs.

Stem Dia. 10mm, Stem Length: 12mm

KIA Amanti, Magentis, Optima & Rondo
Pink Nylon Trim Panel Retainer
Top Head Dia. 15mm, Middle Head Dia. 16mm,
Bottom Head Dia. 18mm
#82315-27000

INTERIOR RETAINERS

LEXUS

ATTACHES DE SOUTEIN INTÉRIEUR



247-600

Std. Pkg. 25 pcs.

Top Head Dia. 13mm, Stem Length: 11mm

LEXUS 2003-on
Garnish Moulding Retainer
Middle Head Dia. 16mm, Bottom Head Dia. 15mm
Stem Dia. 9mmx9mm, Overall Length: 17mm
#62217-13010

247-602

Std. Pkg. 25 pcs.

Top Head Dia. 13mm, Stem Length: 13mm

LEXUS 1998-on
Door Panel & Rocker Moulding Retainer
Middle Head Dia. 16mm, Bottom Head Dia. 18mm
Stem Dia. 10mm, Overall Length: 20mm
#67771-12080

INTERIOR RETAINERS

MAZDA

ATTACHES DE SOUTEIN INTÉRIEUR



247-092

Std. Pkg. 15 pcs.

White Nylon Trim Panel Retainer With Sealer

MAZDA 3, 5, 6, Miata & RX-8 2003-on
White Nylon Trim Panel Retainer With Sealer
#GJ6R-68-ABX

247-604

Std. Pkg. 15 pcs.

Top Head Dia. 14mm, Stem Length: 14mm

MAZDA 3, 5, 6, CX7 Miata & Protégé 2001-on
Door Trim Panel Retainer With Sealer
Bottom Head Dia. 18mm, Stem Dia. 12mm,
#G18K-51-SJ3

CL Part No: 910-0490, Pieces: 1

247-851

Std. Pkg. 25 pcs.

Screw Size: No. 8 (M4.2)

MAZDA
Screw Grommet
Head Dia. 16mm, Stem Length: 17mm,
Fits into 8mm x 8mm Hole
#H001-50-841



247-856

Std. Pkg. 25 pcs.

Screw Size: No. 10

MAZDA
Natural Nylon
17mm Wide, 17mm Long,
Fits into 8mm x 8.5mm Hole
#9991-00-503

CL Part No: 910-1945, Pieces: 6



247-605

Std. Pkg. 25 pcs.

Head Dia. 7mm, Stem Length: 6mm

MERCEDES-BENZ C, CL, CLK, E, SLK & S Class 1996-on
White Nylon Hood & Trunk Moulding Insert
Fits into 5.5mm Hole
#201-997-22-81



247-083

Std. Pkg. 25 pcs.

Head Dia. 16mm, Stem Length: 16mm

MITSUBISHI
Trim Panel Retaining Clip
Stem Dia. 7mm
#MC440901



247-851

Std. Pkg. 25 pcs.

Screw Size: No. 8

MITSUBISHI
Screw Grommet
Head Dia. 16mm, Stem Length: 17mm,
Fits into 8mm x 8mm Hole
#MS-480012



247-852

Std. Pkg. 25 pcs.

Screw Size: No. 10

MITSUBISHI
Screw Grommet
Head Dia. 18mm, Stem Length: 17mm,
Fits into 8.5mm x 8.5mm Hole
#MB-098145



247-855

Std. Pkg. 25 pcs.

Screw Size: No. 10

MITSUBISHI
Screw Grommet
12mm Wide, 12mm Long,
Fits into 8mm x 9mm Hole
#MS-480002

CL Part No: 910-1955, Pieces: 12



245-218 Std. Pkg. 25 pcs.

Black Nylon Trim Panel Retainer

NISSAN
Black Nylon Trim Panel Retainer
#89427-98070

CL Part No: 910-0330, Pieces: 3



245-219 Std. Pkg. 25 pcs.

Black Nylon Trim Panel Retainer

NISSAN
Black Nylon Trim Panel Retainer
#76996-01P02

CL Part No: 910-0335, Pieces: 3



247-075 Std. Pkg. 25 pcs.

Head Dia. 14mm, Stem Length: 16mm

NISSAN
Trim Retainer Clip
Snaps into 6mm Hole, Panel thickness: 5mm
#76906-T3000

CL Part No: 910-0889, Pieces: 10



247-083 Std. Pkg. 25 pcs.

Head Dia. 16mm, Stem Length: 16mm

NISSAN
Trim Panel Retaining Clip
Stem Dia. 7mm
#62660-48600-1



247-848 Std. Pkg. 25 pcs.

Screw Size: No. 8 (M4.2)

NISSAN 1989-on
Bumper/Fender & Light Screw Grommet
Head Dia. 16mm, Stem Length: 10mm,
Fits into 9mm x 9mm Hole
#01281-00831



247-851 Std. Pkg. 25 pcs.

Screw Size: No. 8 (M4.2)

NISSAN
Screw Grommet
Head Dia. 16mm, Stem Length: 17mm,
Fits into 8mm x 8mm Hole
#01651-00481, 74798-S9000



247-852 Std. Pkg. 25 pcs.

Screw Size: No. 10

NISSAN
Screw Grommet
Head Dia. 18mm, Stem Length: 17mm,
Fits into 8.5mm x 8.5mm Hole
#01281-00023



247-856 Std. Pkg. 25 pcs.

Screw Size: No. 10

NISSAN
Screw Grommet
17mm Wide, 17mm Long,
Snaps into 8mm x 8.5 mm Hole
#68425-H5000

CL Part No: 910-1945, Pieces: 6



247-880 Std. Pkg. 25 pcs.

Head Dia. 13mm, Stem Length: 15mm

NISSAN
Retaining Clip
Fits into 5mm Hole, Panel thickness: 3mm
#01553-00172



247-068 Std. Pkg. 25 pcs.
Black Nylon Trim Panel Retainer
 TOYOTA
 Black Nylon Trim Panel Retainer
 #67771-01010
CL Part No: 910-0455, Pieces: 3



247-074 Std. Pkg. 25 pcs.
Head Dia. 14mm, Stem Length: 10mm
 TOYOTA
 Trim Retainer
 Panel Thickness: 3mm, Fits into 5mm Hole
 #90467-06161-01
CL Part No: 910-0890, Pieces: 2



247-600 Std. Pkg. 25 pcs.
Top Head Dia. 13mm, Stem Length: 11mm
 TOYOTA Corolla, Matrix & 4Runner 2003-on
 Garnish Moulding Retainer
 Middle Head Dia. 16mm, Bottom Head Dia. 15mm
 Stem Dia. 9mm x 9mm, Overall Length: 17mm
 #62217-13010



247-602 Std. Pkg. 25 pcs.
Top Head Dia. 13mm, Stem Length: 13mm
 TOYOTA 1998-on
 Door Panel & Rocker Moulding Retainer
 Middle Head Dia. 16mm, Bottom Head Dia. 18mm
 Stem Dia. 10mm, Overall Length: 20mm
 #67771-12080



247-839 Std. Pkg. 25 pcs.
Screw Size: No. 14 (M6.3-1.81)
 TOYOTA
 Screw Grommet
 Head Dia. 20mm, Stem Length: 17mm,
 Fits into 8mm x 8mm Hole
 #90189-06013



247-850 Std. Pkg. 25 pcs.
Screw Size: No. 6
 TOYOTA
 Screw Grommet
 Head Dia. 14mm, Stem Length: 15mm,
 Fits into 7mm x 7mm Hole
 #90189-04013
CL Part No: 910-1908, Pieces: 2



247-851 Std. Pkg. 25 pcs.
Screw Size: No. 8 (M4.2)
 TOYOTA
 Screw Grommet
 Head Dia. 16mm, Stem Length: 17mm,
 Fits into 8mm x 8mm Hole
 #90189-06042



247-852 Std. Pkg. 25 pcs.
Screw Size: No. 10
 TOYOTA
 Screw Grommet
 Head Dia. 18mm, Stem Length: 17mm,
 Fits into 8.5mm x 8.5mm Hole
 #90189-06001



247-853 Std. Pkg. 25 pcs.
Screw Size: No. 6
 TOYOTA
 Screw Grommet
 Head Dia. 14mm, Stem Length: 10mm,
 Fits into 7mm x 7mm Hole
 #90189-04066



247-855 Std. Pkg. 25 pcs.
Screw Size: No. 10
 TOYOTA
 Screw Grommet
 12mm Wide, 12mm Long,
 Fits into 8mm x 9mm Hole
 #90189-05013
CL Part No: 910-1955, Pieces: 12



247-880 Std. Pkg. 25 pcs.
Head Dia. 13mm, Stem Length: 15mm
 TOYOTA
 Retaining Clip
 Fits into 5mm Hole, Panel thickness: 3mm
 #90467-07050



247-025

Std. Pkg. 25 pcs.

Black Nylon Door Trim Panel Retainer

VW 1975-on
Black Nylon Door Trim Panel Retainer
#N989022

CL Part No: 910-0230, Pieces: 3

247-081

Std. Pkg. 25 pcs.

Head Dia. 22mm, Stem Length: 10mm

VW Beetle, Golf, Jetta & Passat 1998-on
Door Trim Panel Retainer
Fits into 10mm Hole
#3B0-868-243

247-087

Std. Pkg. 25 pcs.

Head Dia. 19mm, Stem Length: 20mm

VW
Black Nylon Trim Panel Retainer
Fits into 8mm Hole
#N902-016-01H



247-100

Std. Pkg. 25 pcs.

Door Trim Panel Retainer

VW 1976-on
Door Trim Panel Retainer
#N98905101

CL Part No: 910-0420, Pieces: 3

AMC
CHRYSLER
FORD

EXTERIOR RETAINERS

GM
JEEP

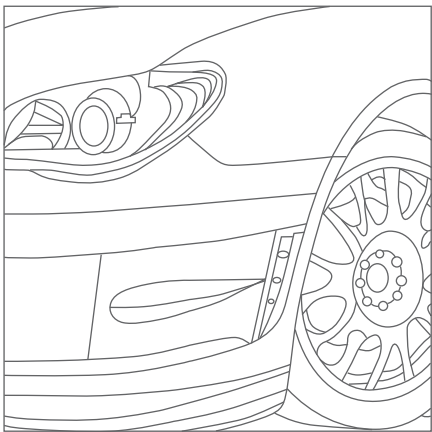
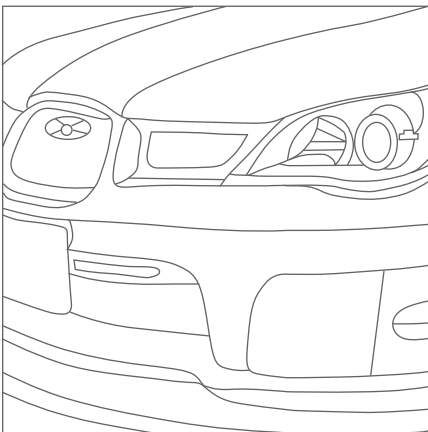
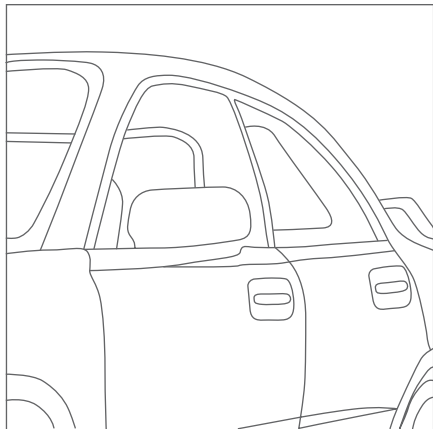
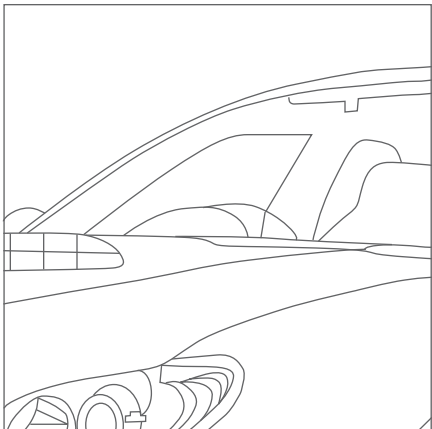

DOMESTIC
DOMESTIQUES

ATTACHES DE SOUTIEN EXTERIEUR

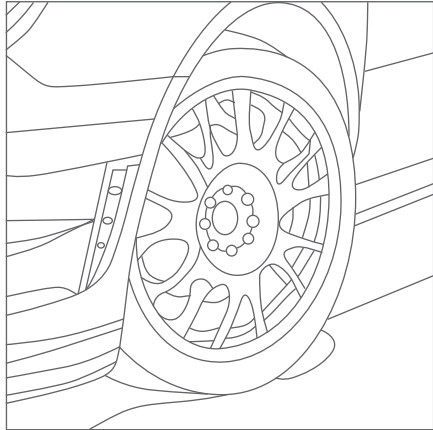



247-213

Std. Pkg. 25 pcs.

Black Nylon Trim Panel Retainer

AMC 1988-84
Black Nylon Trim Panel Retainer
#4006529



247-215

Std. Pkg. 25 pcs.

Fender/Bumper Shield Retainer

AMC
Fender/Bumper Shield Retainer
#4004569

CL Part No: 910-0215, Pieces: 5



247-812

Std. Pkg. 25 pcs.

Screw Size: No. 8

AMC Renault 1980-on
Rear License Plate Bracket
#8934-201-262

CL Part No: 910-2065, Pieces: 3



247-821

Std. Pkg. 25 pcs.

Screw Size: No. 8

AMC Renault
Radiator Grille Nut
#8934-201-263

CL Part No: 910-1920, Pieces: 8



247-849

Std. Pkg. 25 pcs.

Screw Size: No. 6 or 8

AMC
Nylon
#4000141

CL Part No: 910-2020, Pieces: 5

EXTERIOR RETAINERS

CHRYSLER

ATTACHES DE SOUTEIN EXTÉRIEUR



247-002

Std. Pkg. 25 pcs.

Door Frame Spacer Retainer

CHRYSLER 1985-on
Door Frame Spacer Retainer
#4381395, 6501086

CL Part No: 910-0380, Pieces: 5



247-057

Std. Pkg. 25 pcs.

Sliding Door & Lift Gate Trim Panel Retainer

CHRYSLER Mini Vans 1987-on
Sliding Door & Lift Gate Trim Panel Retainer
#6501301

CL Part No: 910-0340, Pieces: 2



247-058

Std. Pkg. 25 pcs.

Trim Panel Retainer

CHRYSLER
Trim Panel Retainer
Not Available through O.E.M.

CL Part No: 910-0375, Pieces: 3



247-157

Std. Pkg. 25 pcs.

Grille Clip

PLYMOUTH LASER
Grille Clip
13mm Wide, 22mm Long

CL Part No: 910-0905, Pieces: 3



247-211

Std. Pkg. 25 pcs.

Rad. Yoke Fender & Bumper Shield Retainer

CHRYSLER
Rad. Yoke Fender & Bumper Shield Retainer
#6030441

CL Part No: 910-0225, Pieces: 6



247-213

Std. Pkg. 25 pcs.

Black Nylon Trim Panel Retainer

CHRYSLER 1988-84
Black Nylon Trim Panel Retainer
#5208743



247-215 Std. Pkg. 25 pcs.
Fender/Bumper Shield Retainer
 CHRYSLER
 Fender/Bumper Shield Retainer
 #3691590, 6031321
 CL Part No: 910-0215, Pieces: 5



247-221 Std. Pkg. 25 pcs.
Trim Panel Retainer
 CHRYSLER
 Shield Retainer, Battery Post Cable Shield,
 Engine Splash Shield Radiator Side Air Baffle
 #6033082, 6033840
 CL Part No: 910-0355, Pieces: 2



247-224 Std. Pkg. 25 pcs.
Engine Compartment & Front End Retainer
 CHRYSLER 2000-on
 Engine Compartment & Front End Retainer
 #6505667-AA



247-229 Std. Pkg. 10 pcs.
Shield Retainer
 CHRYSLER Dodge Daytona 1993
 Black Nylon Headlight Mounting Panel To
 Cross Member Sight Shield Retainer
 #6502104
 CL Part No: 910-0356, Pieces: 1



247-233 Std. Pkg. 25 pcs.
Shroud Retainer
 CHRYSLER
 Shroud Retainer
****High Retention Capability****
 CL Part No: 910-0300, Pieces: 4



247-235 Std. Pkg. 25 pcs.
Mud Shield Retainer
 CHRYSLER
 Mud Shield Retainer
 #3861577
 CL Part No: 910-0245, Pieces: 5



247-236 Std. Pkg. 25 pcs.
Radiator Grille Retainer
 CHRYSLER
 Radiator Grille Retainer
 #2998430
 CL Part No: 910-0205, Pieces: 3



247-237 Std. Pkg. 25 pcs.
Black Nylon Fascia Retainer
 CHRYSLER 1985-on
 Black Nylon Fascia Retainer
 #6501067



247-238 Std. Pkg. 25 pcs.
Hood Insulation & Fender Shield Retainer
 CHRYSLER 1985-on
 Hood Insulation & Fender Shield Retainer
 #4341060
 CL Part No: 910-0510, Pieces: 3



247-239 Std. Pkg. 25 pcs.
Black Nylon Hood Insulation Retainer
 CHRYSLER LH & LHS Series 1997-on
 Black Nylon Hood Insulation Retainer
 #4878883AA



247-241 Std. Pkg. 25 pcs.
Hood Insulation Retainer
 CHRYSLER Concorde, Dodge Intrepid
 & Eagle Vision 1993-on
 Hood Insulation Retainer
 #6502842



247-242 Std. Pkg. 25 pcs.
Splash Shield & Wheel Well Cover Retainer
 CHRYSLER 1988-on
 Splash Shield & Wheel Well Cover Retainer
 #6501916
 CL Part No: 910-0320, Pieces: 3



247-245

Std. Pkg. 25 pcs.

Black Nylon Hood Insulation Retainer

CHRYSLER 1972-on
Black Nylon Hood Insulation Retainer
#6003351



247-396

Std. Pkg. 25 pcs.

Head Dia. 19/32", Stem Length: 29/32"

CHRYSLER 1987-on
Black Nylon Push-Type Retainer
Fits into 1/4" Hole
#6502871

CL Part No: 910-0682, Pieces: 2



247-400

Std. Pkg. 25 pcs.

Head Dia. 23/32", Stem Length: 29/32"

LHS, Concorde, Intrepid & Eagle Vision 1998-on
Push-Type Retainer
Fits into 5/16" Hole
#6504521

CL Part No: 910-0645, Pieces: 2



247-406

Std. Pkg. 25 pcs.

Head Dia. 11/16", Stem Length: 7/8"

CHRYSLER 1998-on
Rad. Shroud/Trim Retainer
Fits into 1/4" Hole
#4638136

CL Part No: 910-0690, Pieces: 3



247-407

Std. Pkg. 25 pcs.

Head Dia. 11/16", Stem Length: 9/16"

CHRYSLER 1981-on
Fender Liner Retainer
Fits into 1/4" Hole
#34201621, 6504090

CL Part No: 910-0800, Pieces: 4



247-409

Std. Pkg. 25 pcs.

Head Dia. 27/32", Stem Length: 1"

CHRYSLER 1990-on
Screw-in Type Retainer
Fits into 1/2" Hole
#6502625

CL Part No: 910-0700, Pieces: 2



247-412

Std. Pkg. 25 pcs.

Large Head Dia. 3/8", Stem Length: 7/16"

CHRYSLER
Tail Light Retainer
Fits into 3/16" Hole
#6500787



247-413

Std. Pkg. 25 pcs.

Head Dia. 20mm, Stem Length: 20mm

CHRYSLER 1991-on
Air Baffle to Under Carriage Retainer
Fits into 8mm Hole
#6503598

CL Part No: 910-0585, Pieces: 2



247-414

Std. Pkg. 25 pcs.

Large Head Dia. 23/32", Stem Length: 29/32"

CHRYSLER LHS, Concorde, Intrepid & Eagle Vision 1998-on
Black Nylon Fascia Push-Type Retainer
Fits into 5/16" Hole
#65045 21

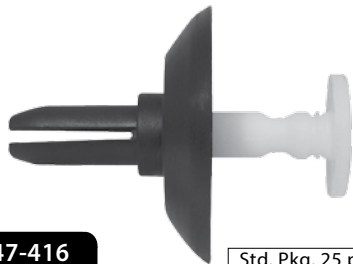

247-416

Std. Pkg. 25 pcs.

Head Dia. 34mm, Stem Length: 20mm

CHRYSLER 1998-on
Black & White Nylon Push-Type Retainer
Fits into 8mm Hole
#4805405AA



247-417

Std. Pkg. 25 pcs.

Head Dia. 17mm, Stem Length: 16mm

CHRYSLER 2000-on
Fender/Front Bumper Cover Retainer
Fits into 6mm Hole
#6506008AA

CL Part No: 910-0605, Pieces: 2



247-419

Std. Pkg. 15 pcs.

Head Dia. 24mm, Stem Length: 20mm

CHRYSLER 300 & Dodge Magnum 2005-on
Black & White Nylon Front Bumper
Push-Type Retainer
Shoulder Length: 3mm, Fits into 11mm Hole
#4806110-AA



247-433 Std. Pkg. 25 pcs.
Head Dia. 1/2", Stem Length: 1-13/64"
 CHRYSLER 1987-on
 Black Nylon Push-Type Retainer
 Fits into 9/32" Hole
 #4696488, 6503163



247-459 Std. Pkg. 25 pcs.
Head Dia. 20mm , Stem Length: 17mm
 CHRYSLER Sebring & Stratus 2001-on
 Black Nylon Side Radiator Shield Push-Type
 Retainer
 Fits into 7mm Hole
 #6506132-AA



247-466 Std. Pkg. 25 pcs.
Head Dia. 11/16", Stem Length: 7/8"
 CHRYSLER
 Body Panel Retainer
 Fits into 1/4" Hole
 #34202672
CL Part No: 910-0550, Pieces: 4

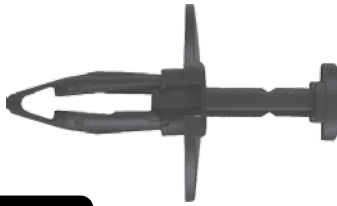

247-467 Std. Pkg. 25 pcs.
Head Dia. 1", Stem Length: 7/8"
 CHRYSLER
 Fascia Retainer
 Shoulder Length: 1/8", Fits into 5/16" Hole
 #6501590
CL Part No: 910-0635, Pieces: 3



247-469 Std. Pkg. 25 pcs.
Large Head Dia. 21mm , Stem Length: 23mm
 CHRYSLER Caravan Town & Country, Voyager
 Mini Vans 2002-on
 Black Nylon Tail Light Housing Push-Type Retainer
 Fits into 9.5mm Hole
 #4857345-AA



247-475 Std. Pkg. 25 pcs.
Head Dia. 11/16", Stem Length: 7/16"
 CHRYSLER 1978-on
 Grille Retainer
 Fits Into 9/32" Hole
 #6031383
CL Part No: 910-0785, Pieces: 2



247-480 Std. Pkg. 25 pcs.
Head Dia. 11/16", Stem Length: 5/8"
 CHRYSLER 1968-on
 Cowl Ledge Weatherstrip & Fender Liner
 Fits into 1/4" Hole
 #6031390



247-511 Std. Pkg. 25 pcs.
Head Dia. 18mm, Stem Length: 20mm
 CHRYSLER 2000-on
 Fender, Wheel & Bumper Retainer
 Fits into 9.5mm Hole, Panel Range: 3.0mm-5.8mm
 #6508712AA
CL Part No: 910-0615, Pieces: 2



247-512 Std. Pkg. 25 pcs.
Screw Size: No. 10 (M4.8)
 CHRYSLER Mini Van & Pacifica 2002-on
 Front Bumper Cover Retainer Nut
 Fits into 12mm Square Hole
 #6506109-AA

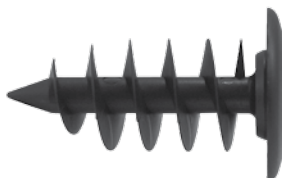

247-568 Std. Pkg. 25 pcs.
M14 -34mm
 CHRYSLER 2005-on
 Black Nylon Bumper and Door Insulator Nylon Screw
 Head O.D. 22mm, Fits into 12mm Hole,
 Square Drive: No. 3
 Not Available through O.E.M.



247-725 Std. Pkg. 25 pcs.
Screw Size: No. 8
 CHRYSLER
 Radiator Grille Nut
 #6031234



247-726 Std. Pkg. 25 pcs.
Screw Size: No. 6 or 8
 CHRYSLER
 Radiator Grille Nut
 #6031183
CL Part No: 910-2055, Pieces: 3



247-821

Std. Pkg. 25 pcs.

Screw Size: No. 8

CHRYSLER
Radiator Grille Nut
#6000943

CL Part No: 910-1920, Pieces: 8

247-825

Std. Pkg. 25 pcs.

Screw Size: No. 8 or 10

CHRYSLER
Headlight Bezel Nut
#2524525

CL Part No: 910-2025, Pieces: 5

247-869

Std. Pkg. 25 pcs.

Head Size: 11/16", Stem Length: 13/16"

CHRYSLER Concorde & LHS Dodge Intrepid
& Eagle Vision 1993-on
Black Nylon Push-Type Retainer
Fits Into 1/4" Hole
#6501925

CL Part No: 910-0595, Pieces: 3



247-874

Std. Pkg. 25 pcs.

Head Dia. 18mm, Stem Length: 17.5mm

CHRYSLER 2002-on
Black Nylon Air Distributor & Windshield
Defroster Push-Type Retainer
Panel Range: 2.0mm - 4.5mm, Fits Into 6.5mm Hole
#6508863-AA

CL Part No: 910-0625, Pieces: 2

247-890

Std. Pkg. 25 pcs.

Head Dia. 19mm, Stem Length: 16mm

CHRYSLER
Fascia & General Purpose Push-Type Retainer
Panel Range: 5.0mm - 7.0mm, Fits Into 8mm Hole
#5116530-AA

CL Part No: 910-0630, Pieces: 1

EXTERIOR RETAINERS

FORD

ATTACHES DE SOUTEIN EXTÉRIEUR



247-002

Std. Pkg. 25 pcs.

Bumper Retainer

FORD 1981-on
Bumper Retainer
#388904-S

CL Part No: 910-0380, Pieces: 5

247-024

Std. Pkg. 25 pcs.

Fascia to Bumper Retainer

FORD 1981-on
Fascia to Bumper Retainer
#389443-S

CL Part No: 910-0265, Pieces: 4

247-157

Std. Pkg. 25 pcs.

Grille Clip

FORD ESCORT
Grille Clip
13mm Wide, 22mm Long

CL Part No: 910-0905, Pieces: 3



247-211

Std. Pkg. 25 pcs.

Rad. Yoke Fender & Bumper Shield Retainer

FORD
Rad. Yoke Fender & Bumper Shield Retainer
#3885775

CL Part No: 910-0225, Pieces: 6

247-215

Std. Pkg. 25 pcs.

Fender/Bumper Shield Retainer

FORD
Fender/Bumper Shield Retainer
#389358

CL Part No: 910-0215, Pieces: 5

247-217

Std. Pkg. 25 pcs.

Black Nylon Cowl Vent Retainer

FORD Trucks 2004-on
Black Nylon Cowl Vent Retainer
#W710312-S300



247-221 Std. Pkg. 25 pcs.
Trim Panel Retainer
 FORD
 Shield Retainer, Battery Post Cable Shield,
 Engine Splash Shield Radiator Side Air Baffle
 #390018-S
 CL Part No: 910-0355, Pieces: 2



247-222 Std. Pkg. 25 pcs.
Bumper Fascia Retainer
 FORD Taurus and Sable 1986-on
 Bumper Fascia Retainer
 #N804379S
 CL Part No: 910-0310, Pieces: 4



247-230 Std. Pkg. 25 pcs.
Black Nylon Splash Shield and Wire Retainer
 FORD
 Black Nylon Splash Shield and Wire Retainer
 #384051-S



247-231 Std. Pkg. 25 pcs.
 Head Dia. 1-3/16"
 FORD 1974-on
 Hood Insulation Plastic Retainer
****For Heavier Type Insulation****
 #385595-S, 386553-S



247-232 Std. Pkg. 25 pcs.
 Head Dia. 7/16", Stem Length: 1/2"
 FORD Mustang & CAPRI 1984-on
 Facia Retainer
 #N803170-S
 CL Part No: 910-0280, Pieces: 3



247-233 Std. Pkg. 25 pcs.
Shroud Retainer
 FORD
 Shroud Retainer
****High Retention Capability****
 CL Part No: 910-0300, Pieces: 4



247-234 Std. Pkg. 25 pcs.
Hood Insulation & Door Weatherstrip Retainer
 FORD Mustang 2005-on
 Hood Insulation & Door Weatherstrip
 Retainer
 #N811040-S



247-235 Std. Pkg. 25 pcs.
Mud Shield Retainer
 FORD
 Mud Shield Retainer
 #387258-S
 CL Part No: 910-0245, Pieces: 5



247-240 Std. Pkg. 25 pcs.
 Head Dia. 11mm, Stem Length: 35mm
 FORD
 Radiator Attaching Retainer
 Fits into 4.75mm Hole, Panel Range: 5-29mm
 #N-800505-S



247-245 Std. Pkg. 25 pcs.
Black Nylon Grille to Radiator Retainer
 FORD 1973-on
 Black Nylon Grille to Radiator Retainer
 #385330-S, D30Z-16776-A



247-252 Std. Pkg. 25 pcs.
Hood Insulation Retainer
 FORD 1975-on
 Hood Insulation Retainer
 #386553-S
 CL Part No: 910-0520, Pieces: 6



247-253 Std. Pkg. 25 pcs.
Black Nylon Hood Insulation Retainer
 FORD 1975-on
 Black Nylon Hood Insulation Retainer
 #388908-S

**247-396**

Std. Pkg. 25 pcs.

Head Dia. 19/32", Stem Length: 29/32"

FORD 1987-on
Black Nylon Push-Type Retainer
Fits into 1/4" Hole
#N803946S

CL Part No: 910-0682, Pieces: 2

**247-406**

Std. Pkg. 25 pcs.

Head Dia. 11/16", Stem Length: 7/8"

FORD 1986-on
Rad. Shroud/Trim Retainer
Fits into 1/4" Hole
#N804570-S

CL Part No: 910-0690, Pieces: 3

**247-413**

Std. Pkg. 25 pcs.

Head Dia. 20mm, Stem Length: 20mm

FORD 1991-on
Air Baffle to Under Carriage Retainer
Fits into 8mm Hole
#N807389-S

CL Part No: 910-0585, Pieces: 2

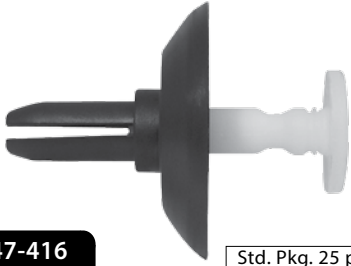
**247-416**

Std. Pkg. 25 pcs.

Head Dia. 34mm, Stem Length: 20mm

FORD Trucks 2005-on
Black & White Nylon Push-Type Retainer
Fits into 8mm Hole
#1L5Z-17K826AA

**247-418**

Std. Pkg. 25 pcs.

Head Dia. 16mm, Stem Length: 18mm

FORD Focus 2000-on
Black Nylon Push-Type Retainer
Fits into 6mm Hole
#YS4Z-16K262-AA

**247-421**

Std. Pkg. 25 pcs.

Head Dia. 18mm, Stem Length: 18mm

FORD Taurus & Sable 2000-on
Black Nylon & Santoprene Rubber Bumper
Push-Type Retainer
Fits into 8mm Hole
Not Available through O.E.M.

**247-422**

Std. Pkg. 15 pcs.

Width: 5/8", Length: 1"

GM Trucks & Vans 1999-on
Black Radiator Grille & Bumper Cover Fastener
Overall Height: 5/8"
#15078238

**247-426**

Std. Pkg. 25 pcs.

Head Dia. 18mm, Stem Length: 23mm

FORD Mustang/Capri 1985-on
Fascia Retainer
Fits into 7mm Hole
#N803716-S

CL Part No: 910-0940, Pieces: 3

**247-429**

Std. Pkg. 25 pcs.

Head Dia. 1", Stem Length: 29/32"

FORD 1987-on
Black Nylon Push-Type Retainer
Fits into 1/4" Hole
#N804837S

CL Part No: 910-0636, Pieces: 2

**247-433**

Std. Pkg. 25 pcs.

Head Dia. 1/2", Stem Length: 1-13/64"

FORD 1987-on
Black Nylon Push-Type Retainer
Fits into 9/32" Hole
#N805026S

**247-446**

Std. Pkg. 25 pcs.

Head Dia. 11/16", Stem Length: 11/16"

FORD 1987-on
Black Nylon Push-Type Retainer
Fits into 1/4" Hole
#N808147S

CL Part No: 910-0681, Pieces: 3

**247-448**

Std. Pkg. 25 pcs.

Trim Panel & Hood Insulation Retainer

FORD 1983-on
Trim Panel & Hood Insulation Retainer
#N802734-S

CL Part No: 910-0315, Pieces: 5



247-458 Std. Pkg. 25 pcs.
Head Dia. 25mm, Stem Length: 20mm
 FORD 2005-on
 Fender, Flare, Gas Tank & Panel Attach. Push-Type Retainer
 Fits into 10.5mm Hole, Panel Range: 3.0mm-6.0mm
 #W712665-S300
CL Part No: 910-0651, Pieces: 2



247-460 Std. Pkg. 25 pcs.
Head Dia. 3/4", Stem Length: 11/16"
 FORD Truck 1978-on
 Grille to Metal Stamping Retainer
 Shoulder Length: 1/4", Fits into 1/4" Slot
 #387944-S
CL Part No: 910-0795, Pieces: 2



247-462 Std. Pkg. 25 pcs.
Head Dia. 1", Stem Length: 7/8"
 FORD
 Splash Shield/Fascia Retainer
 Fits into 1/4" Hole
 #N802781-S
CL Part No: 910-0570, Pieces: 3



247-464 Std. Pkg. 25 pcs.
Head Dia. 5/8", Stem Length: 17/32"
 FORD Taurus, Topaz & Sable 1989-on
 Black Nylon Push-Type Retainer
 Fits into 1/4" Hole
 #N805231S
CL Part No: 910-0790, Pieces: 4



247-465 Std. Pkg. 25 pcs.
Head Dia. 19/32", Stem Length: 5/8"
 FORD 1978-on
 Fender Sheild Retainer
 Fits into 1/4" Hole
 #387843-S
CL Part No: 910-0790, Pieces: 4



247-466 Std. Pkg. 25 pcs.
Head Dia. 11/16", Stem Length: 7/8"
 FORD 1984-on
 Body Panel Retainer
 Fits into 1/4" Hole
 #N803362-S
CL Part No: 910-0550, Pieces: 4



247-467 Std. Pkg. 25 pcs.
Head Dia. 1", Stem Length: 7/8"
 FORD
 Fascia Retainer
 Shoulder Length: 1/8", Fits into 5/16" Hole
 #N803421-S
CL Part No: 910-0635, Pieces: 3



247-468 Std. Pkg. 25 pcs.
Stem Length: 21/32"
 FORD 1985-on
 Fascia/Trim/Grille Retainer
 Head Size: 15/32"x15/32", Fits into 1/4" Square Hole or Slot
 #N803494-S
CL Part No: 910-0691, Pieces: 2



247-470 Std. Pkg. 25 pcs.
Head Dia. 5/8", Stem Length: 7/16"
 FORD
 Grille/Headlight Bracket Retainer
 Fits into 1/4" Hole
 #383142-S



247-473 Std. Pkg. 25 pcs.
Head Dia. 15mm, Stem Length: 20mm
 FORD
 Black Nylon Push-Type Retainer
 Fits into 8mm Hole
 #F3LY-14570-B
CL Part No: 910-0590, Pieces: 3



247-494 Std. Pkg. 25 pcs.
Head Dia. 20mm, Stem Length: 18mm
 FORD Probe & Aspire 1995-on
 Push-Type Retainer
 Fits into 8mm Hole
 #MNA01-56145, NA01-56145
CL Part No: 910-0705, Pieces: 2



247-508 Std. Pkg. 25 pcs.
Head Dia. 20mm, Stem Length: 26mm
 FORD 1997-on
 Bumper Cover/Fender Shield
 Fits into 8mm Hole
 #W708530-S300



247-510

Std. Pkg. 25 pcs.

Head Dia. 20mm, Stem Length: 22mm

FORD 2006-on
Cowl Vent/Fender Retainer
Fits into 8.5mm Hole, Panel Range: 4.5mm-7.0 mm
#W712196-S300

CL Part No: 910-0620, Pieces: 2

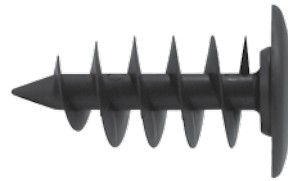

247-568

Std. Pkg. 25 pcs.

M14-34mm

FORD 2005-on
Black Nylon Bumper and Door Insulator Nylon Screw
Head O.D. 22mm, Fits into 12mm Hole, No. 3 Square Drive
Not Available through O.E.M.



247-730

Std. Pkg. 25 pcs.

Screw Size: No. 6

FORD 1978-on
Grille Attachment Nut
#N800503-S

CL Part No: 910-2050, Pieces: 5



247-810

Std. Pkg. 25 pcs.

Screw Size: No. 8

FORD 1986-on
Headlight Door, Grille & Mirror Nut
Fits into 1/4" Square Hole
#379830-S

CL Part No: 910-2030, Pieces: 7

EXTERIOR RETAINERS

GM

ATTACHES DE SOUTEIN EXTÉRIEUR



247-056

Std. Pkg. 25 pcs.

Front End Stone Shield Retainer

GM 1981-on
Front End Stone Shield Retainer
#22512276

CL Part No: 910-0270, Pieces: 3



247-057

Std. Pkg. 25 pcs.

Trim Panel Retainer

GM Saturn 1991-on
Trim Panel Retainer
#21094146

CL Part No: 910-0340, Pieces: 2



247-111

Std. Pkg. 25 pcs.

Head Dia. 20mm, Stem Length: 8mm

Pontiac Vibe 2003-on
Rocket Panel Retainer & Garnish Moulding
Fits into 7mm Hole
#88970494, 88973676



247-200

Std. Pkg. 25 pcs.

Remote Control Door Lock Receiver Retainer

Chevrolet Lumina & Monte Carlo, Olds mobile Cutlass
and Pontiac Bonneville & Grand Prix 1991-on
Remote Control Door Lock Receiver Retainer
#10063599

CL Part No: 910-0360, Pieces: 10



247-201

Std. Pkg. 25 pcs.

Wiring Harness & Headliner Retainer

GM C, E, K, S & T Trucks 1994-on
Wiring Harness & Headliner Retainer
Engine Wiring Harness, Tailgate, Headliner & Air Cleaner
#15975244

CL Part No: 910-0370, Pieces: 3



247-202

Std. Pkg. 25 pcs.

Trim Panel Retainer

GM
Trim Panel Retainer
(White version of 247-211)

CL Part No: 910-0365, Pieces: 5



247-211 Std. Pkg. 25 pcs.
Rad. Yoke Fender & Bumper Shield Retainer
 GM
 Rad. Yoke Fender & Bumper Shield Retainer
 #1595864, 1605396
CL Part No: 910-0225, Pieces: 6



247-212 Std. Pkg. 25 pcs.
Screen Shroud Vent Grille to Panel Retainer
 GM 1985-on
 Screen Shroud Vent Grille to Panel Retainer
 #20514862
CL Part No: 910-0305, Pieces: 5



247-215 Std. Pkg. 25 pcs.
Fender/Bumper Shield Retainer
 GM
 Fender/Bumper Shield Retainer
 #332364, 14093311, 20732399
CL Part No: 910-0215, Pieces: 5



247-216 Std. Pkg. 25 pcs.
Radiator Apron Panel Retainer
 GM 1977-on
 Radiator Apron Panel Retainer
 #1619321
CL Part No: 910-0260, Pieces: 3



247-220 Std. Pkg. 25 pcs.
Head Dia. 18mm, Stem Length: 23mm
 GM GEO Storm 1990-on
 Black Nylon Inner Fender Shield & Bumper Fascia Retainer
 Stem Dia. 7mm
 #94145515
CL Part No: 910-0345, Pieces: 1



247-221 Std. Pkg. 25 pcs.
Trim Panel Retainer
 GM 1989-on
 Shield Retainer, Battery Post Cable Shield,
 Engine Splash Shield Radiator Side Air Baffle
 #10121502
CL Part No: 910-0355, Pieces: 2



247-222 Std. Pkg. 25 pcs.
Bumper Fascia Retainer
 BUICK, CADILLACS & OLDS 1981-on
 Bumper Fascia Retainer
 #1631564
CL Part No: 910-0310, Pieces: 4



247-224 Std. Pkg. 25 pcs.
Engine Compartment & Front End Retainer
 GM 2000-on
 Engine Compartment & Front End Retainer
 #22189414



247-227 Std. Pkg. 25 pcs.
Stem Length: 14mm
 PONTIAC G6 2005-on
 Front Bumper Push Type Retainer
 Head Size: 14mmx26mm, Fits into 8mm Hole
 #12337831



247-230 Std. Pkg. 25 pcs.
Black Nylon Cowl Insulation Retainer
 GM
 Black Nylon Cowl Insulation Retainer
 #480534



247-233 Std. Pkg. 25 pcs.
Shroud Retainer
 GM
 Shroud Retainer
****High Retention Capability****
CL Part No: 910-0300, Pieces: 4



247-234 Std. Pkg. 25 pcs.
Hood Insulation & Door Weatherstrip Retainer
 GM Chevrolet Cobalt 2005-on
 Hood Insulation & Door Weatherstrip Retainer
 #10293193



247-235

Std. Pkg. 25 pcs.

Mud Shield Retainer

GM 1976-on
Mud Shield Retainer
#20032850

CL Part No: 910-0245, Pieces: 5



247-241

Std. Pkg. 25 pcs.

Hood Insulation Retainer

GM Corvette Equinox & Saturn 1992-on
Hood Insulation Retainer
#21039129



247-242

Std. Pkg. 25 pcs.

Hood Seal Retainer

GM 1989-on
Hood Seal Retainer
#22547243

CL Part No: 910-0320, Pieces: 3



247-243

Std. Pkg. 25 pcs.

Rear Hood Seal Retainer

GM 1983-on
Rear Hood Seal Retainer
#14074081

CL Part No: 910-0285, Pieces: 2



247-248

Std. Pkg. 25 pcs.

Hood Insulation Retainer

GM 1980-on
Hood Insulation Retainer
#20064875

CL Part No: 910-0505, Pieces: 3



247-249

Std. Pkg. 5 pcs.

Hood Insulation Retainer

GM 1964-on
Hood Insulation Retainer
#3977775, 3078511

CL Part No: 910-0500, Pieces: 4



247-250

Std. Pkg. 25 pcs.

Hood Insulation Retainer

GM 1980-on
Hood Insulation Retainer
2" Square
#389809



247-297

Std. Pkg. 25 pcs.

Head Dia. 28mm, Stem Length: 13mm

C & K Trucks 1999-on
Front Air Deflector Retainer ****Use with 247-298****
#15733970

CL Part No: 910-0965, Pieces: 2



247-298

Std. Pkg. 15 pcs.

Flange Dia. 30mm, Stem Length: 24mm

C & K Trucks 1999-on
Front Air Deflector Retainer ****Use with 247-297****
Small Head Dia. 18mm, Med. Head Dia. 26mm
#15733971

CL Part No: 910-0960, Pieces: 1



247-397

Std. Pkg. 25 pcs.

Head Dia. 27/32", Stem Length: 1"

GM 1987-on
Black Nylon Push-Type Retainer
Fits into 13/32" Hole
#15672330, 15956470

CL Part No: 910-0683, Pieces: 1



247-401

Std. Pkg. 15 pcs.

Head Dia. 1", Stem Length: 3/4"

GM 1979-on
Fascia Retainer
Shoulder Length: 1/8", Fits into 1/2" Hole
#5973400

CL Part No: 910-0805, Pieces: 2



247-402

Std. Pkg. 25 pcs.

Head Dia. 7/8", Stem Length: 25/32"

GM 1979-on
Blue Nylon Fascia Retainer
Shoulder Length: 5/32", Fits Into 1/2" Hole
#5973823

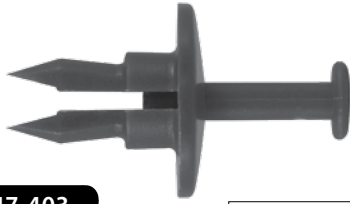

247-403 Std. Pkg. 25 pcs.
Head Dia. 1", Stem Length: 7/8"
 GM 1982-on
 Fascia Retainer
 Shoulder Length: 1/4", Fits into 1/2" Hole
 #5973996
CL Part No: 910-0560, Pieces: 4



247-404 Std. Pkg. 25 pcs.
Head Dia. 11/16", Stem Length: 7/8"
 GM 1984-on
 Exterior Body Panel Retainer
 Fits into 9/32" Hole
 #20590899, 20452072
CL Part No: 910-0560, Pieces: 4

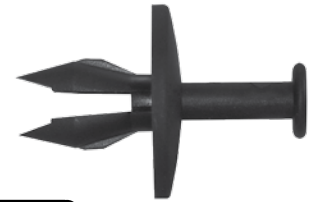

247-405 Std. Pkg. 20 pcs.
Head Dia. 1", Stem Length: 23/32"
 GM 1982-on
 Fascia Retainer
 Fits into 3/8" Hole
 #14045480
CL Part No: 910-0565, Pieces: 3



247-406 Std. Pkg. 25 pcs.
Head Dia. 11/16", Stem Length: 7/8"
 GM 1982-on
 Radiator Shroud/Trim Retainer
 Fits into 1/4" Hole
 #20664092, 20452072, 15773445
CL Part No: 910-0690, Pieces: 3



247-407 Std. Pkg. 25 pcs.
Head Dia. 11/16", Stem Length: 9/16"
 GM 1981-on
 Fender Liner Retainer
 Fits into 1/4" Hole
 #14019205, 16514113, 14019206
CL Part No: 910-0800, Pieces: 4



247-408 Std. Pkg. 25 pcs.
Head Size: 3/4"x19/32", Stem Length: 19/32"
 GM 1981-on
 Grille Attachment Retainer
 Fits into 5/16" Hole, Stem Length: 19/32"
 #14032200
CL Part No: 910-0815, Pieces: 3



247-409 Std. Pkg. 25 pcs.
Head Dia. 27/32", Stem Length: 1"
 GM APV Vans 1990-on
 Screw-in Type Retainer
 Fits into 1/2" Hole
 #10140480
CL Part No: 910-0700, Pieces: 2



247-411 Std. Pkg. 25 pcs.
Head Dia. 21/32", Stem Length: 9/16"
 GM 1981-on
 Radiator Overflow Windshield Washer Bottle Retainer
 Fits into 5/16" Hole
 #14019226, 14071289
CL Part No: 910-0810, Pieces: 3



247-412 Std. Pkg. 25 pcs.
Large Head Dia. 3/8", Stem Length: 7/16"
 GM
 Tail Light Retainer
 Fits into 3/16" Hole
 #16500308



247-413 Std. Pkg. 25 pcs.
Head Dia. 20mm, Stem Length: 20mm
 GM Saturn 2Dr & 4Dr 1991-on
 Air Baffle to Under Carriage Retainer
 Fits into 8mm Hole
 #21030249
CL Part No: 910-0585, Pieces: 2



247-417 Std. Pkg. 25 pcs.
Head Dia. 17mm, Stem Length: 16mm
 GM C&K Truck 1999-on
 Fender/Front Bumper Cover Retainer
 Fits into 6mm Hole
 #15149708
CL Part No: 910-0605, Pieces: 2



247-423 Std. Pkg. 25 pcs.
Head Dia. 19mm, Stem Length: 14mm
 BUICK Enclave & LaCrosse, Cadillac, CTS, SRX & STS Chevrolet Cobalt, Equinox & Malibu, GM Trucks & Pontiac G5, G6 & Torrent 2003-on
 Fender Apron Retainer
 Panel Ran: 2.7mm-5.3mm, Fits into 8.5mm Hole
 #11609417
CL Part No: 910-0610, Pieces: 4

**247-424**

Std. Pkg. 25 pcs.

Head Dia. 14mm, Stem Length: 16mm

Geo Storm 1990-on
Cowl Panel To Reinforcement Plate
& Engine Splash Shield Retainer
Fits into 6mm Hole
#94051993

CL Part No: 910-0710, Pieces: 3**247-428**

Std. Pkg. 25 pcs.

Head Dia. 1", Stem Length: 7/8"

GM 1984-on
Black Nylon Body Retainer
Fits into 1/4" Hole
#20547865

CL Part No: 910-0807, Pieces: 2**247-433**

Std. Pkg. 25 pcs.

Head Dia. 1/2", Stem Length: 1-13/64"

GM 1987-on
Black Nylon Push-Type Retainer
Fits into 9/32" Hole
#10195515

**247-436**

Std. Pkg. 15 pcs.

Top Head Size: 11 x 15mm, Stem Length: 10mm

GM Saturn Vue 2008-on
Fender, Wheel, Side & Bumper Moulding Clip With Sealer
Bottom Head Dia. 16mm, Fits into 8mm Hole
#94530742

**247-445**

Std. Pkg. 50 pcs.

Head Dia. 25mm, Stem Length: 23mm

GM Buick Enclave and GMC Acadia 2007-on
Panel Attachment & General Purpose
Push-Type Retainer
Fits into 10.5mm Hole, Panel Range: 6.0mm - 9.0mm
#11589296

CL Part No: 910-0655, Pieces: 2**247-446**

Std. Pkg. 25 pcs.

Head Dia. 11/16", Stem Length: 11/16"

GM 1987-on
Black Nylon Push-Type Retainer
Fits into 1/4" Hole
#10139822, 25680782

CL Part No: 910-0681, Pieces: 3**247-447**

Std. Pkg. 25 pcs.

Head Dia. 1", Stem Length: 7/8"

GM 1984-on
Splash Shield, Seat Cushion & Spare Tire Retainer
Fits into 5/16" Hole
#20570245, 20635065

CL Part No: 910-0555, Pieces: 2**247-448**

Std. Pkg. 25 pcs.

Trim Panel & Hood Insulation Retainer

GM 1997-on
Trim Panel & Hood Insulation Retainer
#22718305

CL Part No: 910-0315, Pieces: 5**247-450**

Std. Pkg. 25 pcs.

Head Dia. 7/16", Stem Length: 9/32"

GM 1979-on
A/C Vent Retainer
Fits into 3/16" Hole
#14005089

**247-452**

Std. Pkg. 50 pcs.

Head Dia. 18mm, Stem Length: 20mm

Buick Enclave, Cadillac CTS & STS, Chevrolet Cobalt, Equinox
& SSR, GM Trucks and Pontiac G5 & Torrent 2002-on
Push-Type Retainer
Fits into 6.5mm Hole, Panel Range: 4.5mm - 7.0mm
#11589290

CL Part No: 910-0611, Pieces: 3**247-455**

Std. Pkg. 25 pcs.

Trim Panel Retainer

GM
Trim Panel Retainer
#10017619

**247-456**

Std. Pkg. 25 pcs.

Head Dia. 20mm, Stem Length: 20mm

Chevrolet & GMC C & K Trucks 2007-on
Bumper Fascia, Flares & Air Dam
Push-Type Retainer
Fits into 8.5mm Hole, Panel Range: 2.0mm - 4.5mm
#11589292

CL Part No: 910-0650, Pieces: 2



247-457

Std. Pkg. 25 pcs.

Head Dia. 20mm , Stem Length: 24mm

Buick Enclave & LaCrosse, Chevrolet & GMC C & K Trucks, GMC Acadia, Hummer H3, Saturn Outlook 2005-on
Push-Type Retainer
Fits into 8.5mm Hole, Panel Range: 7.0mm - 10.0mm
#11589294

CL Part No: 910-0765, Pieces: 2



247-458

Std. Pkg. 25 pcs.

Head Dia. 25mm, Stem Length: 20mm

Chevrolet Cobalt & HHR, GM C & K Trucks and Pontiac G5 2005-on
Fender, Flare, Gas Tank & Panel Attach. Push-Type Retainer
Fits into 10.5mm Hole, Panel Range: 3.0mm-6.0mm
#11589295

CL Part No: 910-0651, Pieces: 2



247-462

Std. Pkg. 25 pcs.

Head Dia. 1", Stem Length: 7/8"

GM 1979-on
Splash Shield/Fascia Retainer
Fits into 1/4" Hole
#14093088

CL Part No: 910-0570, Pieces: 3



247-466

Std. Pkg. 25 pcs.

Head Dia. 11/16", Stem Length: 7/8"

GM 1984-on
Body Panel Retainer
Fits into 1/4" Hole
#20510029

CL Part No: 910-0550, Pieces: 4



247-468

Std. Pkg. 25 pcs.

Head Size: 15/32"x15/32", Stem Length: 21/32"

GM 1994-on
Fascia/Trim/Grille Retainer
Fits into 1/4" Square Hole or Slot
#15679091

CL Part No: 910-0691, Pieces: 2



247-473

Std. Pkg. 25 pcs.

Head Dia. 15mm, Stem Length: 20mm

GM Saturn (2 Door & 4 Door Models) 1991-on
Push-Type Retainer
Rocker Panel, Wheel Liner & Air Inlet Duct Applications
Fits into 8mm Hole
#11561878, 21075686

CL Part No: 910-0590, Pieces: 3



247-476

Std. Pkg. 25 pcs.

Top Head: 9/16"x13/16", Stem Length: 9/16"

GM 1992-on
Rocker Moulding & Grille Moulding Clip
Bottom Head: 5/8"x13/16", Fits into 3/8" Hole
#25724529



247-480

Std. Pkg. 25 pcs.

Head Dia. 11/16", Stem Length: 5/8"

GM 1970-on
Cowl Ledge Weatherstrip & Fender Liner
Fits into 1/4" Hole
#472434



247-493

Std. Pkg. 25 pcs.

Head Dia. 15mm, Stem Length: 12mm

GM
Push Type Retainer
Fits into 7mm Hole
#20426301

CL Part No: 910-0675, Pieces: 2



247-503

Std. Pkg. 15 pcs.

Head Dia. 18mm, Stem Length: 7.5mm

PONTIAC Vibe 1999-on
Front Fender Liner Retainer
Fits into 7mm Hole
#88970767



247-507

Std. Pkg. 25 pcs.

Head Dia. 18mm, Stem Length: 26mm

PONTIAC Grand Prix 2004-on
Front Bumper Cover Retainer
Fits into 10mm Hole
#11588988



247-508

Std. Pkg. 25 pcs.

Head Dia. 20mm, Stem Length: 26mm

GM 1997-on
Bumper Cover/Fender Shield
Fits into 8mm Hole
#11518017



247-509 Std. Pkg. 25 pcs.
Head Dia. 18mm, Stem Length: 20mm
 Buick Enclave, Cadillac CTS & STS, Chevrolet Cobalt, Equinox & SSR, GM Trucks & Pontiac G5 & Torrent 2002-on
 Grille/Bumper Fascia Retainer
 Fits into 6.5mm Hole, Panel Range: 4.5mm-7.0mm
 #11589290



247-510 Std. Pkg. 25 pcs.
Head Dia. 20mm, Stem Length: 22mm
 GM 1997-on
 Cowl Vent/Fender Retainer
 Fits into 8.5mm Hole, Panel Range: 4.5mm-7.0 mm
 #11589293

CL Part No: 910-0620, Pieces: 2



247-511 Std. Pkg. 25 pcs.
Head Dia. 18mm, Stem Length: 20mm
 Chevrolet Impala, Monte Carlo & Pontiac Solstice, Grand Prix, GM 2004-on
 Fender, Wheel & Bumper Retainer
 Fits into 9.5mm Hole, Panel Range: 3.0mm-5.8mm
 #11561368

CL Part No: 910-0615, Pieces: 2



247-514 Std. Pkg. 25 pcs.
Width: 11mm, Length: 14mm
 Buick Lacrosse & Regal, Cadillac, Chevrolet, GMC C&K Truck, GM 1997-on
 Front & Rear Bumper Moulding Clip
 #11561857

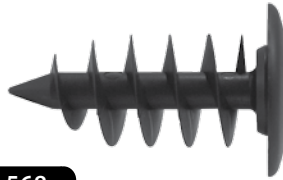

247-568 Std. Pkg. 25 pcs.
M14 – 34mm
 GM 2005-on
 Black Nylon Bumper and Door Insulator Nylon Screw
 Head O.D. 22mm, Fits into 12mm Hole,
 No. 3 Square Drive
 Not Available through O.E.M.

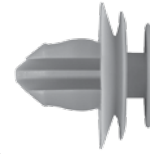

247-601 Std. Pkg. 25 pcs.
Top Head Dia. 13mm, Stem Length: 11mm
 PONTIAC Vibe 2000-on
 Garnish Moulding Retainer
 Middle Head Dia. 16mm, Bottom Head Dia. 18mm
 Stem Dia. 9mm x 9mm
 #88970345



247-716 Std. Pkg. 25 pcs.
Screw Size: No. 6 or 8
 GM 1971-on
 Valance Panel to Rear Bumper Bar Grommet
 #1377030

CL Part No: 910-2095, Pieces: 6



247-811 Std. Pkg. 25 pcs.
Screw Size: No. 6
 GM 1977-on
 Screw Grommet
 Panel Range .60" - .150"
 #1254815



247-812 Std. Pkg. 25 pcs.
Screw Size: No. 8
 GM 1980-on
 Side Marker Nut
 #9669486

CL Part No: 910-2065, Pieces: 3



247-815 Std. Pkg. 25 pcs.
Screw Size: No. 8
 GM 1967-on
 Front End & Instrument Panel Nut
 #3893980

CL Part No: 910-1925, Pieces: 6



247-816 Std. Pkg. 25 pcs.
Screw Size: No. 8
 GM 1974-on
 Headlight Bezel Nut
 #3919773

CL Part No: 910-2015, Pieces: 6



247-817 Std. Pkg. 25 pcs.
Screw Size: No. 6
 GM
 Black Nylon Nut
 3/8 Sq. Head, Fits into 1/4" Sq. Hole
 #16503329

CL Part No: 910-1900, Pieces: 10



247-819 Std. Pkg. 25 pcs.
Screw Size: No. 8
 GM 1967-on
 Headlight Bezel Nut
 Fits into 5/16" Square Hole
 #14013246
CL Part No: 910-2005, Pieces: 5



247-824 Std. Pkg. 50 pcs.
Screw Size: No. 8 or 10
 GM
 Grille Nut
 Head Size: 1/2"
CL Part No: 910-1935, Pieces: 10



247-826 Std. Pkg. 25 pcs.
Screw Size: No. 6 or 8
 GM Buick 1964-on
 Headlight Door to Radiator Grille Anchor Nut
 #1355003
CL Part No: 910-1915, Pieces: 4



247-830 Std. Pkg. 25 pcs.
Screw Size: No.6
 GM
 Headlight Bezel Nut
 Hole Size: 6.5mm x 7.5mm, Stem Length: 8.5mm
 #380382
CL Part No: 910-2000, Pieces: 5



247-831 Std. Pkg. 25 pcs.
Headlight Adjusting Nut
 Chevrolet
 Headlight Adjusting Nut
 Use With 1/4"-28 Screw
 #3921446
CL Part No: 910-2035, Pieces: 5



247-840 Std. Pkg. 25 pcs.
Screw Size: No.14
 GM
 License Plate Nut
 #3907444, 4755299
CL Part No: 910-2075, Pieces: 5



247-860 Std. Pkg. 10 pcs.
Screw Size: No.10
 GM Geo Prizm & Nova
 Fender/Wheel Housing Application Retainer 'U' Nut
 20mm Wide, 31mm Long; Ctr. of Hole to Edge: 11mm,
 Panel Range: Up to 1mm
 #94841226
CL Part No: 910-1340, Pieces: 3



247-865 Std. Pkg. 25 pcs.
Top Head Dia. 13mm, Stem Length: 14mm
 Buick Lucerne; Cadillac CTS, Escalade & SRX; Chevrolet Avalanche,
 Silverado, Tahoe & Traverse; GMC Acadia, Sierra, Suburban &
 Yukon; Hummer H3; Saturn Aura & Outlook 2006-on
 Cowl, Pillar, Trim Panel & Windshield Retainer
 Stem Dia. 10mm, Mid. Head Dia. 16.5mm, Bot. Head Dia. 18mm
 #11561654



247-869 Std. Pkg. 25 pcs.
Head Size: 11/16", Stem Length: 13/16"
 GM 1992-on
 Black Nylon Push-Type Retainer
 Fits Into 1/4" Hole
 #10134407
CL Part No: 910-0595, Pieces: 3



247-873 Std. Pkg. 25 pcs.
Head Dia. 20mm, Stem Length: 28mm
 GM Saturn 1996-on
 Bumper Fascia Push-Type Retainer
 Fits into 8mm Hole
 #21095797
CL Part No: 910-0600, Pieces: 1



247-874 Std. Pkg. 25 pcs.
Head Dia. 18mm, Stem Length: 17.5mm
 Buick Enclave, Chevrolet Equinox, Chevrolet & GMC S & T
 Trucks, GMC Acadia and Pontiac Torrent 2002-on
 Black Nylon Air Distributor & Windshield
 Defroster Push-Type Retainer
 Panel Range: 2.0mm - 4.5mm, Fits Into 6.5mm Hole
 #11589289
CL Part No: 910-0625, Pieces: 2



247-877 Std. Pkg. 25 pcs.
Head Dia. 14mm, Stem Length: 11mm
 GM
 Black Nylon Push-Type Retainer
 Fits into 7mm Hole
 #94198687
CL Part No: 910-0680, Pieces: 2



247-878

Std. Pkg. 25 pcs.

Head Dia. 1", Stem Length: 1-1/8"

GM 1982-on
Black Nylon Bumper Fascia Retainer
Shoulder Length: 1/4", Fits Into 1/2" Hole
#10077283

CL Part No: 910-0575, Pieces: 2



247-885

Std. Pkg. 25 pcs.

Head Dia. 1", Stem Length: 1"

GM 1987-on
Black Nylon Bumper Fascia Retainer
Shoulder Length: 1/8", Fits into 1/2" Hole
#22535007

CL Part No: 910-0580, Pieces: 2



247-890

Std. Pkg. 25 pcs.

Head Dia. 19mm, Stem Length: 16mm

GM 2007-on
Fascia & General Purpose Push-Type Retainer
Panel Range: 5.0mm - 7.0mm, Fits into 8mm Hole
#15296830

CL Part No: 910-0630, Pieces: 1

EXTERIOR RETAINERS

JEEP

ATTACHES DE SOUTEIN EXTÉRIEUR



247-417

Std. Pkg. 25 pcs.

Head Dia. 17mm, Stem Length: 16mm

JEEP Liberty 2002-on
Fender/Front Bumper Cover Retainer
Fits into 6mm Hole
#6506008AA

CL Part No: 910-0605, Pieces: 2



247-511

Std. Pkg. 25 pcs.

Head Dia. 18mm, Stem Length: 20mm

JEEP Wrangler 2000-on
Fender, Wheel & Bumper Retainer
Fits into 9.5mm Hole, Panel Range: 3.0mm-5.8mm
#6508712AA

CL Part No: 910-0615, Pieces: 2

BMW
HONDA
ISUZU
LEXUS

EXTERIOR RETAINERS

MAZDA
NISSAN
TOYOTA

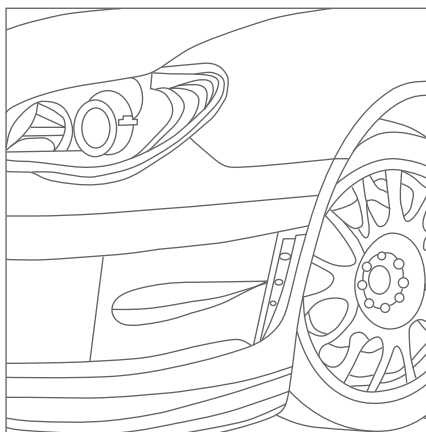
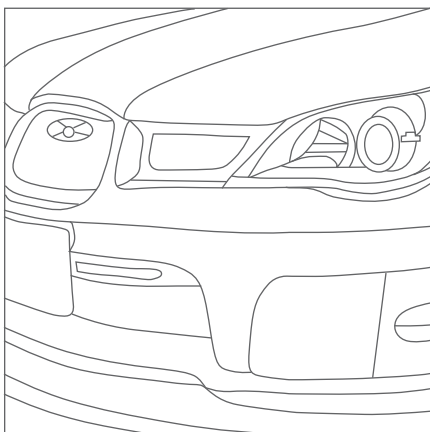
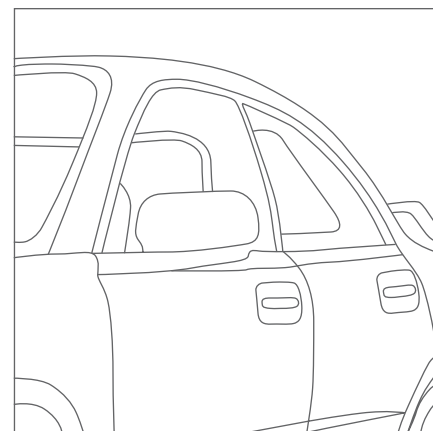
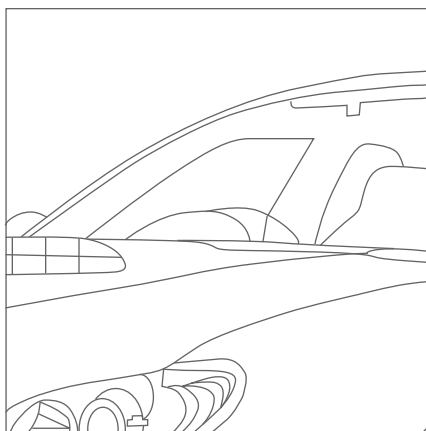

IMPORTS

IMPORTEES

ATTACHES DE SOUTIEN EXTERIEUR

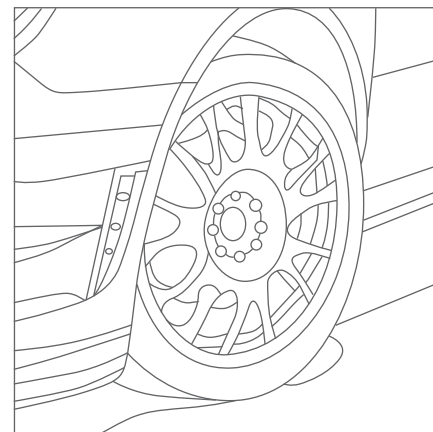



247-440 Std. Pkg. 25 pcs.
Head Dia. 20mm, Stem Length: 16mm
 BMW Series 5 1997-on
 Black Nylon Cowl Vent Push-Type Retainer
**** Use with #247-862****
 #51218-205-295



247-441 Std. Pkg. 25 pcs.
Bumper Trim Retainer
 BMW 1995-on
 Bumper Trim Retainer
 #51-11-8-174-185



247-442 Std. Pkg. 25 pcs.
Hood/Trunk Insulation Retainer
 BMW 1984-2001
 Hood/Trunk Insulation Retainer
 #51-48-1-938-725



247-444 Std. Pkg. 25 pcs.
Head Dia. 20mm, Stem Length: 15mm
 BMW Series 3, 5, 7 & X5 1989-on
 Black Nylon Bumper, Wheel Opening, Scuff
 Plate & Interior Trim Push-Type Retainer
 Fits into 6.3mm Hole
 #51-11-1-944-537



240-833 Std. Pkg. 25 pcs.
Screw Size: No.10
 HONDA
 Nylon Nut
 13mm Wide, 13mm Long, Snaps into 8.5 x 8.5mm Hole
 #75521-611-0000
CL Part No: 910-1940, Pieces: 5



247-067 Std. Pkg. 25 pcs.
Head Dia. 12mm, Stem Length: 9mm
 HONDA Civic, Acura Integra 1994-on
 Hood/Trunk Moulding Retainer
 Fits into 6mm Hole
 #91518-SM4-003
CL Part No: 910-0880, Pieces: 3



247-078 Std. Pkg. 25 pcs.
Head Dia. 10mm, Stem Length: 10mm
 HONDA Acura 1990-on
 Hood Insulation Retainer Clip
 Fits into 6mm Hole, Panel thickness: 4mm
 #91520-SM4-C010
CL Part No: 910-0515, Pieces: 3



247-086 Std. Pkg. 25 pcs.
Head Dia. 30mm, Stem Length: 14mm
 HONDA Civic & CRV, Acura 3.5 RL & RSX 2000-on
 Hood Insulation Retainer
 Stem Dia. 15mm x 20mm
 #91501-S1K-003



247-157 Std. Pkg. 25 pcs.
Grille Clip
 HONDA
 Grille Clip
 13mm Wide, 22mm Long
CL Part No: 910-0905, Pieces: 3



247-159 Std. Pkg. 15 pcs.
Body Side Moulding Clip
 HONDA Legend 1987-on
 Body Side Moulding Clip
 #91501-SG0-003
CL Part No: 910-0915, Pieces: 3



247-161 Std. Pkg. 10 pcs.
Belt Moulding Clip
 HONDA Civic 1992-on
 Belt Moulding Clip
 #91510-SR3-003
CL Part No: 910-0945, Pieces: 1



247-162 Std. Pkg. 25 pcs.
Body Side Moulding Clip
 HONDA Accord 1986-on
 Body Side Moulding Clip
 #91534-SE0-000
CL Part No: 910-0920, Pieces: 3



247-223 Std. Pkg. 15 pcs.
Head Dia. 20mm, Stem Length: 15mm
 HONDA Civic 2006-on
 Cowl/Garnish Retainer
 Stem Dia. 7mm
 #91501-SEA-003



247-275 Std. Pkg. 15 pcs.
Cowl Top Retaining Clip
 HONDA Accord 1990-on
 Cowl Top Retaining Clip
 #91501-SM4-003
CL Part No: 910-0895, Pieces: 3



247-474 Std. Pkg. 15 pcs.
Head Dia. 18mm, Stem Length: 12mm
 HONDA 1998-on
 Fender & Bumper Push Type Retainer
 Fits into 9mm Hole
 Not Available through O.E.M.
CL Part No: 910-0860, Pieces: 1

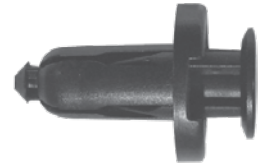

247-477 Std. Pkg. 25 pcs.
Bumper Retainer
 HONDA Acura 1996-on
 Bumper Retainer
 #91503-SZ5-003



247-479 Std. Pkg. 25 pcs.
Head Dia. 18mm, Stem Length: 15mm
 HONDA 1992-on
 Black Nylon Bumper Cover & Wheel Housing
 Push-Type Retainer
 Fits into 9mm Hole



247-482 Std. Pkg. 25 pcs.
Head Dia. 20mm, Stem Length: 13mm
 HONDA Acura 3.5RL Sedan 1996-on
 Front Bumper Retainer
 Fits into 10mm Hole
 #91503-SZ3-003
CL Part No: 910-0845, Pieces: 2



247-483 Std. Pkg. 25 pcs.
Head Dia. 20mm, Stem Length: 11mm
 HONDA Acura 3.5 RL, Accord, Prelude &
 Odyssey 1994-on
 Front Fender/Bumper Support Retainer
 Fits into 8mm Hole
 #91512-SX0-003
CL Part No: 910-0850, Pieces: 2



247-484 Std. Pkg. 25 pcs.
Head Dia. 17mm, Stem Length: 9mm
 HONDA 1990-on
 Black Nylon Cowl Panel Push-Type Retainer
 Fits into 8mm Hole
 #91508-SR3-000
CL Part No: 910-0760, Pieces: 1



247-486 Std. Pkg. 25 pcs.
Head Dia. 20mm, Stem Length: 10mm
 HONDA Civic & DEL SOL 1993-on
 Front Fender Retainer
 Fits into 8mm Hole
 #91501-S04-003
CL Part No: 910-0840, Pieces: 2

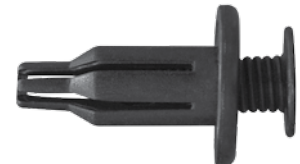

247-487 Std. Pkg. 25 pcs.
Head Dia. 20mm, Stem Length: 25mm
 HONDA 1990-on
 Front/Rear Bumper Retainer
 Fits into 10mm Hole
 #91502-SPO-003
CL Part No: 910-0755, Pieces: 1



247-488 Std. Pkg. 25 pcs.
Head Dia. 20mm, Stem Length: 9mm
 HONDA Accord 1990-on
 Fender Splash Shield Retainer
 Fits into 8mm Hole
 #91512-SM4-003
CL Part No: 910-0740, Pieces: 2



247-490 Std. Pkg. 25 pcs.
Head Dia. 20mm, Stem Length: 9mm
 HONDA
 Push Type Retainer
 Fits into 8mm Hole
 #90675-SB3-003
CL Part No: 910-0695, Pieces: 2



247-491 Std. Pkg. 25 pcs.
Head Dia. 15mm, Stem Length: 11mm
 HONDA
 Push Type Retainer
 Fits into 6mm Hole
 #90684-SA5-0030



247-492 Std. Pkg. 25 pcs.
Head Dia. 18mm, Stem Length: 11mm
 HONDA
 Push Type Retainer
 Fits into 6mm Hole
 #90688-SB0-003
CL Part No: 910-0685, Pieces: 2

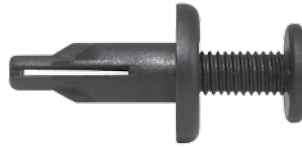

247-495 Std. Pkg. 25 pcs.
Head Dia. 18mm, Stem Length: 21mm
 HONDA Accord 1990-on
 Push Type Retainer
 Fits into 8mm Hole
 #90505-SM4-003
CL Part No: 910-0715, Pieces: 1



247-496 Std. Pkg. 25 pcs.
Head Dia. 20mm, Stem Length: 27mm
 HONDA Accord 1990-on
 Bumper Fascia Retainer
 Fits into 10mm Hole
 #91502-SM4-000
CL Part No: 910-0720, Pieces: 2



247-497 Std. Pkg. 25 pcs.
Head Dia. 20mm, Stem Length: 24mm
 HONDA Accord 1990-on
 Bumper Fascia Retainer
 Fits into 10mm Hole
 #91504-SM4-000
CL Part No: 910-0725, Pieces: 2



247-498 Std. Pkg. 15 pcs.
Flange Dia. 18mm, Stem Length: 21mm
 HONDA
 Black Nylon Push-Type Retainer
 Fits into 8mm Hole
 #90505-SM4-003



247-499 Std. Pkg. 25 pcs.
Head Dia. 13mm, Stem Length: 11mm
 HONDA Prelude 1983-on
 Cowl Vent Panel Retainer
 Fits into 6mm Hole
 #90687-SB0-003, 90687-SB0-013
CL Part No: 910-0730, Pieces: 2



247-500 Std. Pkg. 15 pcs.
Head Dia. 20mm, Stem Length: 13mm
 HONDA Civic 2006-on
 Black Nylon Front Bumper Push-Type
 Retainer With Internal Metal Insert
 Fits into 10mm Hole
 #91505-S9A-003



247-504 Std. Pkg. 15 pcs.
Stem Length: 6mm
 HONDA Accord 2003-on
 Blue Nylon with Sealer Cowl Vent Grommet
 Flange Size: 10mm x 24mm
 #90603-S75-003

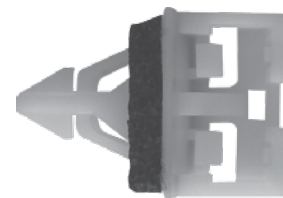

247-505 Std. Pkg. 15 pcs.
Stem Length: 22mm
 HONDA 2001-on
 Bumper Retainer w/Sealer
 Head Size: 20mm x 23mm x 15mm
 #71592-S5D-000



247-557

Std. Pkg. 25 pcs.

Natural Nylon Weatherstrip Retainer

HONDA Civic 1995-on
Natural Nylon Weatherstrip Retainer
#91530-ST5-003



247-559

Std. Pkg. 15 pcs.

Head Dia. 18mm, Stem Length: 15mm

HONDA Odyssey 1995-on
Push-Type Retainer
Fits into 8mm Hole
#90505-SX0-003

CL Part No: 910-0855, Pieces: 1



247-803

Std. Pkg. 25 pcs.

Head Dia. 20mm, Stem Length: 12mm

HONDA Civic & Odyssey, Acura TSX 2004-on
Fender Apron Grommet
Fits 9mm Square Hole
#90682-SEA-003



247-841

Std. Pkg. 15 pcs.

Screw Size: No. 6

HONDA
Natural Nylon Nut
9.5mm Wide, 9.5mm Long, Snaps into 6mm Sq. Hole
#90655-SA0-0030

CL Part No: 910-1905, Pieces: 6



247-842

Std. Pkg. 25 pcs.

Screw Size: No. 14

HONDA
Natural Nylon Nut
13mm Wide, 15mm Long, Snaps into 8.5mmx10.5mm Hole
#90656-671-6310M1

CL Part No: 910-1965, Pieces: 4



247-845

Std. Pkg. 25 pcs.

Stem Length: 14mm

HONDA Accord 1998-on
Body Side Moulding Retainer
Head Size: 14mm x 14mm
#75306-SV1-A01



247-846

Std. Pkg. 25 pcs.

Belt Moulding Retainer

HONDA Accord 1998-on
Belt Moulding Retainer
Length: 27mm, Width: 20mm
#91562-S84-A01



247-877

Std. Pkg. 25 pcs.

Head Dia. 14mm, Stem Length: 11mm

HONDA
Black Nylon Screw-in Type Retainer
Fits into 7mm Hole
#90657-SA6-0030

CL Part No: 910-0680, Pieces: 2



247-891

Std. Pkg. 25 pcs.

Head Dia. 18mm, Stem Length: 14mm

HONDA Accord 1990-on
Black Nylon Cowl Panel Push-Type Retainer
Fits into 8mm Hole
#91508-SM4-003

CL Part No: 910-0825, Pieces: 1



247-431

Std. Pkg. 15 pcs.

Screw Size: No. 8 (M4.2)

HYUNDAI Accent, Genesis, Santa Fe, Sonata, Tiburon & Veracruz 1995-on
Yellow Nylon Rocker Moulding Grommet With Sealer
Head Size: 17mm x 25mm,
Stem Length: 16mm, Hole Size: 8mm x 10mm
#87759-27000



247-432

Std. Pkg. 15 pcs.

Head Size: 8mm x 22mm

HYUNDAI Sonata
Body Side Moulding Clip With Sealer
Stem Length: 10mm
#87756-2G000



247-439

Std. Pkg. 15 pcs.

Top Head Size: 11mm x 15.5mm

HYUNDAI Genesis & Sonata 2009-on
Rocker Moulding Clip With Sealer
Bottom Head Dia. 16mm
Stem Length: 12mm
#87702-H1000

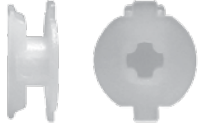

247-606 Std. Pkg. 15 pcs.
Base Dia. 14mm, Overall Height: 6mm
 HYUNDAI Elantra & Sonata 2004-on
 Natural Nylon Body Side Moulding Clip
 Small Head: 6mm x 14mm
 #87719-3D000

247-607 Std. Pkg. 15 pcs.
Screw Size: No. 12 (M5.5)
 HYUNDAI Accent, Santa Fe, Sonata & Tiburon 1995-on
 White Nylon Rocker Moulding Nylon Nut
 Head Size: 13mm x 13mm, Stem Length: 10mm,
 Fits Into 9mm Hole
 #87756-35000

EXTERIOR RETAINERS ISUZU ATTACHES DE SOUTEIN EXTÉRIEUR

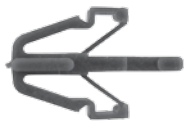

247-157 Std. Pkg. 25 pcs.
Grille Clip
 ISUZU
 Grille Clip
 13mm Wide, 22mm Long
 #8942180270
CL Part No: 910-0905, Pieces: 3

247-220 Std. Pkg. 25 pcs.
Inner Fender Shield & Bumper Fascia Retainer
 ISUZU 1990-on
 Black Nylon Inner Fender Shield & Bumper Fascia Retainer
 Head Dia. 18mm, Stem L. 23mm, Stem Dia. 7mm
 #8941455150
CL Part No: 910-0345, Pieces: 1

247-491 Std. Pkg. 25 pcs.
Head Dia. 15mm, Stem Length: 11mm
 ISUZU 1988-on
 Push Type Retainer
 Fits into 6mm Hole
 #8942981190



247-838 Std. Pkg. 25 pcs.
Screw Size: No. 6
 ISUZU
 Screw Grommet
 16mm Wide, 12mm Long, Snaps into 6mmx10mm Hole
 #8941340270
CL Part No: 910-1907, Pieces: 4

EXTERIOR RETAINERS KIA ATTACHES DE SOUTEIN EXTÉRIEUR

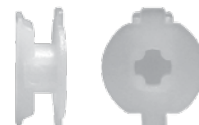

247-432 Std. Pkg. 15 pcs.
Head Size: 8mm x 22mm
 KIA Magnetis & Optima 2006-on
 Body Side Moulding Clip With Sealer
 Stem Length: 10mm

247-494 Std. Pkg. 25 pcs.
Head Dia. 20mm, Stem Length: 18mm
 KIA
 Push-Type Retainer
 Fits into 8mm Hole
 #MNA01-56-145
CL Part No: 910-0705, Pieces: 2

247-606 Std. Pkg. 15 pcs.
Base Dia. 14mm, Overall Height: 6mm
 KIA 2004-On
 Natural Nylon Body Side Moulding Clip
 Small Head: 6mm x 14mm
 #87719-3D000



247-111 Std. Pkg. 25 pcs.
Head Dia. 20mm, Stem Length: 8mm
 LEXUS 2000-on
 Rocket Panel & Garnish Moulding Retainer
 Fits into 7mm Hole
 #90467-07168



247-226 Std. Pkg. 15 pcs.
Splash Shield Retainer
 LEXUS 1997-on
 Splash Shield Retainer



247-228 Std. Pkg. 15 pcs.
Head Dia. 20mm, Stem Length: 10mm
 LEXUS ES300/330
 Engine Under Cover Push-Type Retainer
 Fits into 7mm Hole
 # 90467-07201



247-461 Std. Pkg. 25 pcs.
Bumper Cover Retainer
 LEXUS 1995-on
 Bumper Cover Retainer
 #90467-A0008



247-481 Std. Pkg. 25 pcs.
Head Dia. 15mm, Stem Length: 27mm
 LEXUS LX-400
 Bumper Cover Push-Type Retainer
 Fits into 9mm Hole
 #90467-09093
CL Part No: 910-0745, Pieces: 2



247-503 Std. Pkg. 15 pcs.
Head Dia. 18mm, Stem Length: 7.5mm
 LEXUS 1999-on
 Front Fender Liner Retainer
 Fits into 7mm Hole
 #90467-10183

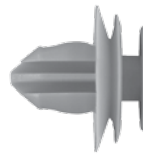

247-601 Std. Pkg. 25 pcs.
Head Dia. 13mm, Stem Length: 11mm
 LEXUS 2000-on
 Garnish Moulding Retainer
 Stem Dia. 9mmx9mm, Overall Length: 18mm
 Middle Head Dia. 16mm, Bottom Head Dia. 18mm
 #90467-10167



247-804 Std. Pkg. 25 pcs.
Black Nylon Headlight Bracket Clip
 LEXUS IS-300
 Black Nylon Headlight Bracket Clip
 25 mm Wide, 40.5 mm Long
 #53271-44010



247-844 Std. Pkg. 15 pcs.
Screw Size: No.12 (M5.5)
 LEXUS
 Black Nylon Bumper & Fender Apron Nylon "U" Nut
 Width: 20mm, Length: 36mm
 Center Of Hole to Edge: 14mm
 Panel Range: Up To 1mm
 #90467-05114



247-868 Std. Pkg. 25 pcs.
Head Dia. 20mm, Stem Length: 12mm
 LEXUS 1990-on
 Push-Type Retainer
 Fits into 7mm Hole
 #90467-07138
CL Part No: 910-0750, Pieces: 1



247-879 Std. Pkg. 25 pcs.
Head Dia. 18mm, Stem Length: 23mm
 LEXUS ES300 1993-on
 Black Nylon Bumper Cover Push-Type Retainer
 Fits 9mm Hole
 #90467-09101
CL Part No: 910-0835, Pieces: 2



240-833

Std. Pkg. 25 pcs.

Screw Size: No.10

MAZDA
Nylon Nut13mm Wide, 13mm Long, Snaps into 8.5 x 8.5mm Hole
#9991-00-601

CL Part No: 910-1940, Pieces: 5

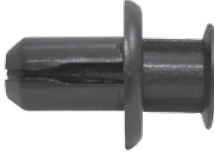

247-472

Std. Pkg. 25 pcs.

Head Dia. 19.5mm, Stem Length: 15mm

MAZDA 1999-on
Bumper Cover & Grille Push-Type Retainer
Fits into 10mm Hole
#GD7A-50-EA1

247-479

Std. Pkg. 25 pcs.

Head Dia. 18mm, Stem Length: 15mm

MAZDA 626 1992-on
Black Nylon Bumper Cover & Wheel Housing
Push-Type Retainer
Fits into 9mm Hole

247-490

Std. Pkg. 25 pcs.

Head Dia. 20mm, Stem Length: 9mm

MAZDA
Push Type Retainer
Fits into 8mm Hole
#FB01-56-964

CL Part No: 910-0695, Pieces: 2



247-493

Std. Pkg. 25 pcs.

Head Dia. 15mm, Stem Length: 12mm

MAZDA
Push Type Retainer
Fits into 7mm Hole
#9926-50-625

CL Part No: 910-0675, Pieces: 2



247-494

Std. Pkg. 25 pcs.

Head Dia. 20mm, Stem Length: 18mm

MAZDA
Push-Type Retainer
Fits into 8mm Hole
#NA01-56-145

CL Part No: 910-0705, Pieces: 2



247-603

Std. Pkg. 15 pcs.

Bottom Head Dia. 16mm, Stem Length: 33mm

MAZDA 3,5 & RX8 2004-on
White Nylon Windshield
Garnish Moulding Retainer
Top Head Size: 10mm x 13mm, Fits into 10mm Hole
#GJ6A-68-162

247-802

Std. Pkg. 25 pcs.

Screw Size: No. 8

MAZDA
Rod End Clip
Holds 4mm Rods, Snaps into 6mm Hole
#9927-80-404

CL Part No: 910-1335, Pieces: 2



247-847

Std. Pkg. 25 pcs.

Screw Size: No. 8

MAZDA
Anchor Nut
9.5mm Wide, 9.5mm Long, Snaps into 7mm Sq. Hole
#9991-00-412

CL Part No: 910-1930, Pieces: 12



247-864

Std. Pkg. 15 pcs.

Bumper Cover Screw Grommet

MAZDA 2000-on
Bumper Cover Screw Grommet
Screw Size: M4.2 (#8) • Head Size: 23mm x 24mm
Stem Length: 14mm
#G6JA-50-0Z5

247-877

Std. Pkg. 25 pcs.

Head Dia. 14mm, Stem Length: 11mm

MAZDA
Black Nylon Push-Type Retainer
Fits into 7mm Hole
#N304-13-356-A

CL Part No: 910-0680, Pieces: 2



247-858

Std. Pkg. 50 pcs.

Red Nylon Moulding Insert

MERCEDES-BENZ
Red Nylon Moulding Insert
#000-988-15-81

EXTERIOR RETAINERS

MITSUBISHI

ATTACHES DE SOUTEIN EXTÉRIEUR

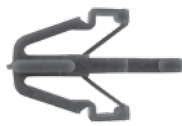

247-157

Std. Pkg. 25 pcs.

Grille Clip

MITSUBISHI & Plymouth Laser
Grille Clip
13mm Wide, 22mm Long

CL Part No: 910-0905, Pieces: 3



247-474

Std. Pkg. 15 pcs.

Head Dia. 18mm, Stem Length: 12mm

MITSUBISHI 1998-on
Fender & Bumper Push-Type Retainer
Fits into 9mm Hole
#MR200300

CL Part No: 910-0860, Pieces: 1



247-483

Std. Pkg. 25 pcs.

Head Dia. 20mm, Stem Length: 11mm

MITSUBISHI Lancer 2002-on
Front Fender/Bumper Support Retainer
Fits into 8mm Hole
#MU000319

CL Part No: 910-0850, Pieces: 2



247-843

Std. Pkg. 15 pcs.

Head Dia. 18mm, Stem Length: 17mm

MITSUBISHI
Screw Grommet
Screw Size No. 10, Fits into 8.5mm Sq. Hole
#MB-098145

CL Part No: 910-1950, Pieces: 5



247-888

Std. Pkg. 15 pcs.

Head Dia. 20mm, Stem Length: 20mm

MITSUBISHI
Front Bumper Fascia Push-Type Retainer
Fits into 8mm Hole
#MB547806

EXTERIOR RETAINERS

NISSAN

ATTACHES DE SOUTEIN EXTÉRIEUR



240-833

Std. Pkg. 25 pcs.

Screw Size: No.10

NISSAN
Nylon Nut
13mm Wide, 13mm Long,
Snaps into 8.5 x 8.5mm Hole
#96706-P0105

CL Part No: 910-1940, Pieces: 5



247-424

Std. Pkg. 25 pcs.

Head Dia. 14mm, Stem Length: 16mm

NISSAN 1980-on
Cowl Panel To Reinforcement Plate & Engine
Splash Shield Retainer
Fits into 6mm Hole
#66860-01W01

CL Part No: 910-0710, Pieces: 3



247-438

Std. Pkg. 25 pcs.

Head Dia. 10mm, Stem Length: 8mm

NISSAN Altima 2009-on
Weatherstrip Retaining Clip
Stem Dia. 6mm
#01553-08961

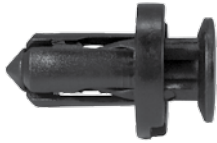

247-453

Std. Pkg. 15 pcs.

Head Dia. 18mm, Stem Length: 15mm

NISSAN 240SX & Maxima 1994-on
Black Nylon Bumper Push-Type Retainer
Fits into 10mm Hole
#01553-09241

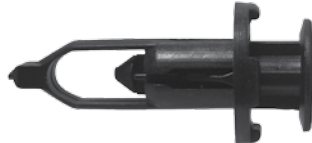

247-454

Std. Pkg. 6 pcs.

Head Dia. 18mm, Stem Length: 28mm

TOYOTA Tercel 1988-on
Rear Bumper Cover Push-Type Retainer
Fits into 9mm Hole
#52161-16010, 52161-02020



247-471

Std. Pkg. 25 pcs.

Head Dia: 22mm, Stem Length: 21mm

NISSAN 1982-on
Black Nylon Front & Rear Bumper Push-Type Retainer
Fits into 8mm Hole
#01553-03201

CL Part No: 910-0595, Pieces: 3



247-490

Std. Pkg. 25 pcs.

Head Dia. 20mm, Stem Length: 9mm

NISSAN
Push-Type Retainer
Fits into 8mm Hole
#63876-95596

CL Part No: 910-0695, Pieces: 2



247-491

Std. Pkg. 25 pcs.

Head Dia. 15mm, Stem Length: 11mm

NISSAN
Push-Type Retainer
Fits into 6mm Hole
#10998-30880



247-494

Std. Pkg. 25 pcs.

Head Dia. 20mm, Stem Length: 18mm

NISSAN 1980-on
Push-Type Retainer
Fits into 8mm Hole
#63844-01A00

CL Part No: 910-0705, Pieces: 2



247-506

Std. Pkg. 25 pcs.

Head Dia.: 20mm, Stem Length: 13mm

NISSAN Altima, Maxima & Quest 2002-on, Infiniti FX 35/45
Black Nylon Front Bumper And Radiator
Support Push-Type Retainer
Fits into 8mm Hole
#11296-AG000



247-527

Std. Pkg. 25 pcs.

Head Size: 8mmx12mm, Stem Length: 8mm

NISSAN Pick-up 1986-on
Black Nylon Cowl Grille Retainer
Fits into 6mm Sq. Hole
#66814-01G00

CL Part No: 910-0820, Pieces: 4

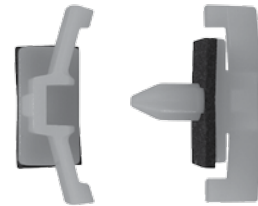

247-608

Std. Pkg. 15 pcs.

Top Width: 25mm, Overall Height: 16mm

NISSAN Infiniti M45, I30 & G35 2005-on,
Altima, Maxima & 350Z 2002-on
White Nylon Drip Moulding Clip With Sealer
Fits into 5mm Hole
Not Available through O.E.M.



247-843

Std. Pkg. 15 pcs.

Screw Size: No.10

NISSAN
Screw Grommet
Head Dia. 18mm, Stem Length: 17mm,
Fits into 8.5mm Sq. Hole
#01281-00023

CL Part No: 910-1950, Pieces: 5



247-847

Std. Pkg. 25 pcs.

Screw Size: No. 8

NISSAN
Anchor Nut
9.5mm Wide, 9.5mm Long,
#96706-B0700

CL Part No: 910-1930, Pieces: 12



247-883

Std. Pkg. 15 pcs.

Head Dia. 22mm, Stem Length: 14mm

NISSAN 1986-on
Black Nylon Bumper & Fascia Push-Type Retainer
Fits into 11mm Hole
#01553-03101

CL Part No: 910-0735, Pieces: 2



247-888

Std. Pkg. 15 pcs.

Head Dia. 20mm, Stem Length: 20mm

NISSAN
Front Bumper Fascia Push-Type Retainer
Fits into 8mm Hole
#63854-01A00



247-889

Std. Pkg. 15 pcs.

Head Dia. 20mm, Stem Length: 9mm

NISSAN Maxima & 300ZX 1994-on
Push-Type Retainer
Fits into 8mm Hole
#01553-09321

EXTERIOR RETAINERS

TOYOTA

ATTACHES DE SOUTEIN EXTÉRIEUR



240-832

Std. Pkg. 25 pcs.

Screw Size: No.10

TOYOTA
Black Nylon Nut
14 mm Wide, 14 mm Long, Snaps into 9mm x 9mm Hole
90189-06018

CL Part No: 910-1960, Pieces: 5



240-833

Std. Pkg. 25 pcs.

Screw Size: No.10

TOYOTA
Nylon Nut
13mm Wide, 13mm Long, Snaps into 8.5 x 8.5mm Hole
#90189-06010

CL Part No: 910-1940, Pieces: 5



247-069

Std. Pkg. 25 pcs.

Retaining Clip

TOYOTA
Head Dia. 30mm, Stem Length: 17mm
Fits into 7mm Hole, Panel Thickness: 6mm
#90467-09008

CL Part No: 910-0891, Pcs: 4



247-111

Std. Pkg. 25 pcs.

Head Dia. 20mm, Stem Length: 8mm

TOYOTA 2000-on
Rocket Panel Garnish Moulding Retainer
Fits into 7mm Hole
#90467-07168



247-156

Std. Pkg. 25 pcs.

Grille Clip

TOYOTA
Grille Clip
13mm Wide, 23mm Long
#90467-13005

CL Part No: 910-0900, Pieces: 3



247-158

Std. Pkg. 10 pcs.

Radiator Grille Clip

TOYOTA Cressida 1987-84-on
Radiator Grille Clip
#90467-17004

CL Part No: 910-0910, Pieces: 3



247-209

Std. Pkg. 25 pcs.

Head Dia. 20mm, Stem Length: 9mm

TOYOTA Camry 2007-on
Radiator Splash Shield Push-Type Retainer
Fits into 7mm Hole
#90467-07214



247-226

Std. Pkg. 15 pcs.

Splash Shield Retainer

TOYOTA 1997-on
Splash Shield Retainer
#90467-07164



247-228

Std. Pkg. 15 pcs.

Head Dia. 20mm, Stem Length: 10mm

TOYOTA Avalon, Camry & Solara 2002-on
Engine Under Cover Push-Type Retainer
Fits into 7mm Hole
#90467-07201



247-461

Std. Pkg. 25 pcs.

Bumper Cover Retainer

TOYOTA 1995-on
Bumper Cover Retainer
#90467-A0008



247-643

Std. Pkg. 15 pcs.

Head Dia. 18mm, Stem Length: 31mm

TOYOTA 2000-on
Bumper Cover & Grille Push-Type Retainer
Fits into 9mm Hole
#52161-20010



247-479

Std. Pkg. 25 pcs.

Head Dia. 18mm, Stem Length: 15mm

TOYOTA Corolla 1992-on
Black Nylon Bumper Cover & Wheel Housing
Push-Type Retainer
Fits into 9mm Hole
#90467-09139



247-493

Std. Pkg. 25 pcs.

Head Dia. 15mm, Stem Length: 12mm

TOYOTA
Screw Type Retainer
Fits into 7mm Hole
#90467-06017

CL Part No: 910-0675, Pieces: 2



247-501

Std. Pkg. 15 pcs.

Head Dia. 20mm, Stem Length: 9mm

TOYOTA Camry 2006-on
Black Nylon Push-Type Retainer
Fits into 9mm Square Hole
#90467-09166



247-503

Std. Pkg. 15 pcs.

Head Dia. 18mm, Stem Length: 7.5mm

TOYOTA Celica, Corolla Matrix & Solara 1999-on
Front Fender Liner Retainer
Fits into 7mm Hole
#90467-10183



247-515

Std. Pkg. 15 pcs.

Head Dia. 20mm, Stem Length: 8mm

TOYOTA Tercel 1994-on
Front Fender Liner Push-Type Retainer
Fits into 7mm Hole
#90467-07166

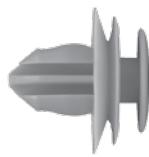

247-601

Std. Pkg. 25 pcs.

Top Head Dia. 13mm, Stem Length: 11mm

TOYOTA 2000-on
Garnish Moulding Retainer
Middle Head Dia. 16mm, Bottom Head Dia. 18mm
Stem Dia. 9mm x 9mm
#90467-10167



247-804

Std. Pkg. 25 pcs.

Black Nylon Headlight Bracket Clip

TOYOTA Camry & RAV 2001-on
Black Nylon Headlight Bracket Clip
25 mm Wide, 40.5 mm Long
#53271-44010



247-838

Std. Pkg. 25 pcs.

Screw Size: No. 6

TOYOTA
Screw Grommet
16mm Wide, 12mm Long, Snaps into 6mm x 10mm Hole
#90189-05012

CL Part No: 910-1907, Pieces: 4



247-843

Std. Pkg. 15 pcs.

Screw Size: No. 10

TOYOTA
Screw Grommet
Head Dia. 18mm, Stem Length: 17mm,
Fits into 8.5mm Sq. Hole
#90189-06001

CL Part No: 910-1950, Pieces: 5



247-844

Std. Pkg. 15 pcs.

Screw Size: No. 12 (M5.5)

TOYOTA
Black Nylon Bumper & Fender Apron Nylon "U" Nut
Width: 20mm, Length: 36mm
Center Of Hole to Edge: 14mm
Panel Range: Up To 1mm
#90467-05114



247-860 Std. Pkg. 10 pcs.

Screw Size: No.10

TOYOTA
 Fender/Wheel Housing Retainer 'U' Nut
 20mm Wide, 31mm Long; Ctr. of Hole to Edge: 11mm
 Panel Range: up to 1mm
 #53879-14020, 53879-22030, 53879-14010-A

CL Part No: 910-1340, Pieces: 3



247-870 Std. Pkg. 10 pcs.

Head Dia.17mm, Stem Length: 17mm

TOYOTA Highlander, Land Cruiser
 Tacoma & Tundra 2001-on
 Fender Moulding Clip
 #90904-67036

CL Part No: 910-0925, Pieces: 2



247-871 Std. Pkg. 10 pcs.

Head Dia.17mm, Stem Length: 13mm

TOYOTA Highlander, Land Cruiser
 Tacoma & Tundra 2001-on
 Fender Moulding Clip
 #90904-67037

CL Part No: 910-0930, Pieces: 2



247-211 Std. Pkg. 25 pcs.

Rad. Yoke Fender & Bumper Shield Retainer

VW
 Rad. Yoke Fender & Bumper Shield Retainer
 #705589-S300

CL Part No: 910-0225, Pieces: 6

DOOR PINS BUSHINGS

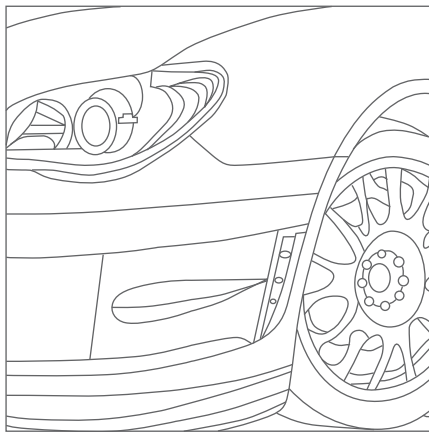
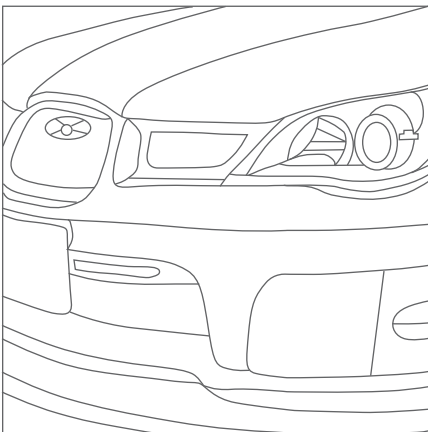
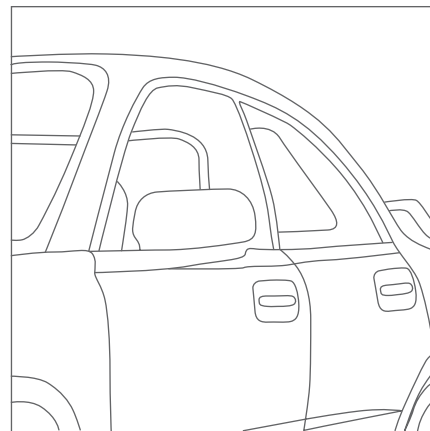
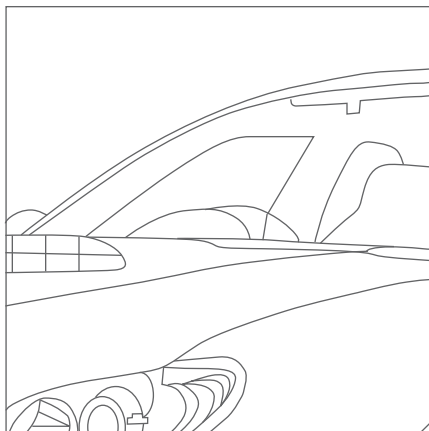

BAGUES DE PORTE GOUPILLES

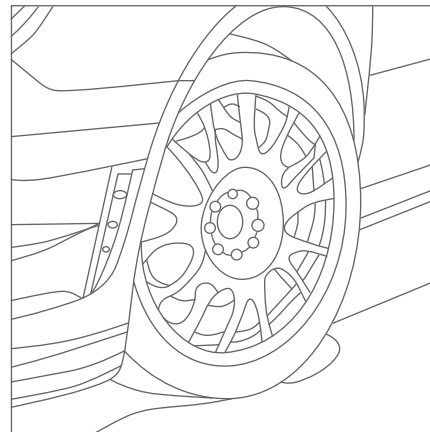

NOT ACTUAL SIZE

**250-561**

Dia. 11/32", Length: 5-1/4"

GM C & K Trucks 1988-2000
Stainless Steel Door Hinge Pin
Shoulder O.D. 3/8", Head O.D. 9/16"
#15591860; 15691595; 15967691; 88891731
CL Part No: 910-1630, Pieces: 1

NOT ACTUAL SIZE

**250-563**

Dia. 9/16", Length: 5-1/2"

GM C & K Trucks 1988-2000
Door Roller Pin Assembly
Knuri Dia. 19/32", Roller Overall Dia. 3/4",
Roller Groove Dia. 5/8"
Not Available through O.E.M.

NOT ACTUAL SIZE

**250-564**

Dia. 25/64", Length: 5-1/16"

GM S & T Trucks 1994-on
Door Roller Pin Assembly
Roller Overall Dia. 3/4",
Roller Groove Dia. 5/8"
#15672183

NOT ACTUAL SIZE

**250-565**

Dia. 11/32", Length: 4-1/8"

S&T Trucks 1994-on
Door Hinge Pin
Overall Head Dia. 1/2", Overall Shoulder Dia. 3/8"
#15653790
CL Part No: 910-1635, Pieces: 1

NOT ACTUAL SIZE

**250-566**

Dia. 11/32", Length: 3-1/2"

RANGER, F150, F250, F350 1998-80
Door Hinge Pin
Knuri Dia. .358", Overall Head Dia. 9/16"

NOT ACTUAL SIZE

**250-567**

Door Hinge Repair Kit

Chevrolet Suburban 1500/2500 & Tahoe 2006-2000, GMC
Yukon 2006-2001, Cadillac Escalade 2006-2000, Chevrolet
Silverado & GMC Sierra 1500/2500, HD/3500, HD 2007-1999
Door Hinge Repair Kit
#89025539

NOT ACTUAL SIZE

**250-568**

Door Hinge Repair Kit

Dodge Ram 1500, 2500 & 3500
pick-up truck 1994-2003
Door Hinge Repair Kit

NOT ACTUAL SIZE

**250-559**

Pin Dia. 11/32", Length: 4-1/16"

BUICK, Cadillac, Chevrolet, Oldsmobile, Pontiac 1992-1973
Door Hinge Pin
Overall Head Dia. 9/16"
#6271989, 20046147
CL Part No: 910-1620, Pieces: 1

**250-545**

Std. Pkg. 25 pcs.

Side Door Upper Hinge

GM Trucks C-K Models 1988-on
Splined O.D. Side Door Upper Hinge
#12338074, 15691493, 15964971, 16632193
CL Part No: 910-1615, Pieces: 2

**250-546**

Std. Pkg. 25 pcs.

Side Door Lower Hinge

GM Trucks C-K Models 1988-on
Splined O.D. Side Door Lower Hinge
#15562609, 15964972, 16632192
CL Part No: 910-1616, Pieces: 2

**250-549**

Std. Pkg. 25 pcs.

Thick Bushing

Chevrolet 1976-on, Corvette 1982-73, Olds Exc.
Starfire: 1980-on, Pontiac Exc. Astre & Sunbird
1980-on, Buick 1976-on, Cadillac 1980-on
Thick Bushing
#9716926, 20345137
CL Part No: 910-1600, Pieces: 3



250-550

Std. Pkg. 25 pcs.

Door Hinge Bushing

BUICK (Exc. Skyhawk) 1967-on, Cadillac 1946-on, Chevrolet (Exc. Monza & Vega) 1962-on, GM C&K Truck 1993-79, Olds (Exc. Starfire) 1949-on, Pontiac (Exc. Astre & Sunbird) 1932-on
GM #9721917, FORD #D1AZ-652284A

CL Part No: 910-1601, Pieces: 2



250-551

Std. Pkg. 25 pcs.

Head Dia. 20mm, Stem Length: 9mm

FORD 1973-on
Door Hinge Bushing
O.D. 31/64, I.D. 11/32, Flange O.D. 19/32
#D90Z-6522841A

CL Part No: 910-1602, Pieces: 2



250-552

Std. Pkg. 25 pcs.

O.D. 5/16", I.D. 17/64"

Dodge & Chrysler 1970-on
Door Hinge Bushing
Length: 23/64", Flange O.D. 33/64"
#4033711

CL Part No: 910-1603, Pieces: 3

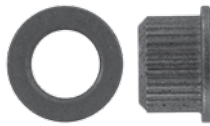

250-553

Std. Pkg. 25 pcs.

O.D. 31/64", I.D. 11/32"

GM (Including Pick-Ups & Vans) 1968-on
Door Hinge Bushing
Length: 23/64", Flange O.D. 19/32" Splined O.D.
#20429500

CL Part No: 910-1610, Pieces: 2



250-560

Pin Dia. 11/32", Length: 4"

BUICK, Chevrolet, Oldsmobile, Pontiac 1978-1995
Overall Head Dia. 7/16"
#20043351

CL Part No: 910-1625, Pieces: 1



250-562

Pin Dia. 17/64", Length: 2-3/4"

Dodge & Plymouth vans, Ramcharger and Trailduster 1970-on
Door Hinge Pin
Cargo doors, lift gates, rear doors and fold-up rear seat floor hinges
Head O. D. 9/16"
#6028993, 6032975



NOT ACTUAL SIZE

250-600

Std. Pkg. 25 pcs.

Hinge Pin & Bushing Kit

GM Savana Van & Express Van 2008-1996
Side Cargo Door Greaseable Stainless Steel
Hinge Pin & Bushing Kit
****Use with Hinge 250-601****
#89025546

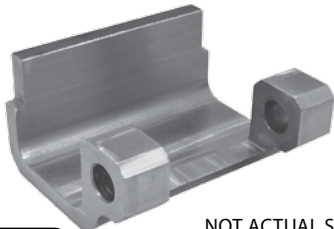

NOT ACTUAL SIZE

250-601

Std. Pkg. 25 pcs.

Side Cargo Door Hinge

GM Savana Van & Express Van 2006-1996
Side Cargo Door Hinge
****Use with Pin & Bushing Kit 250-600****
Not Available through O.E.M.

RIVETS MISCELLANEOUS

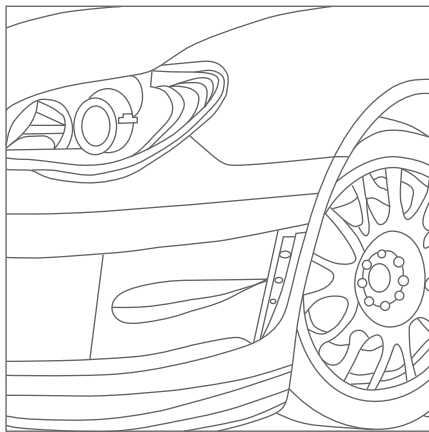
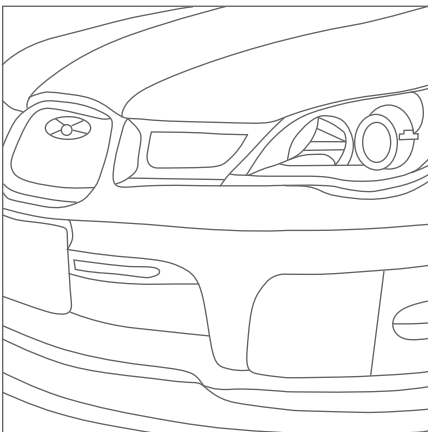
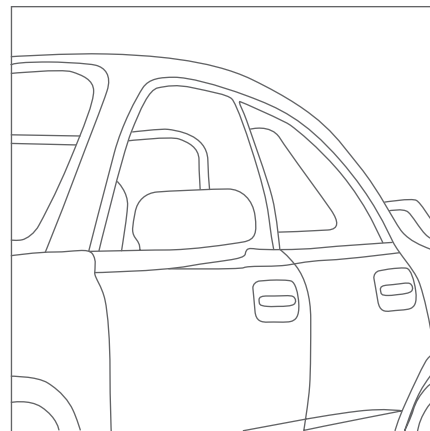
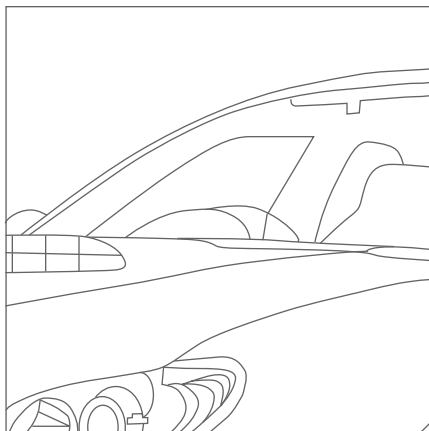

RIVETS DIVERS

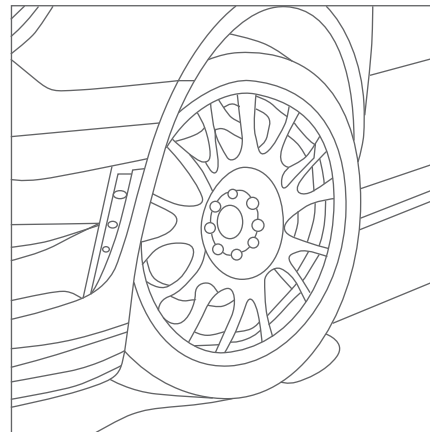



239-900

Pac No. 006-490-30 pcs.

Copper Plated Steel Weld Pin

2 mm (0.080") x 2"
Copper Plated Steel Weld Pin
For pulling out dents



239-901

Pac No. 006-491-30 pcs.

Copper Plated Steel Weld Pin

2.5 mm (0.098") x 2"
Copper Plated Steel Weld Pin
For pulling out dents

RIVETS

RIVETS



239-438

Std. Pkg. 25 pcs.

Hole Dia. 5/32"

VW, JETTA/ RABBIT & GOLF
Black Aluminum Rivet Steel Mandrel
Grip: 1/4" - 3/8", Flange Dia: 15/32"
VW #N900-845-01

CL Part No: 910-1880, Pieces: 3



246-451

Std. Pkg. 10 pcs.

Dia. 1/4" (6.3mm), Flange Dia. 1/2" (13mm)

TOYOTA 2007-on
Fuel Door & General Purpose Specialty Rivet
Grip Range: 1/16"-3/16" (1.6mm - 4.8mm)
#90269-A0005



246-600

Std. Pkg. 25 pcs.

Dia. 1/4", Flange Dia. 1/2"

GM, FORD, CHRYSLER 1971-on
Window Regulator Rivet
Grip Range 1/32-9/64
GM #9436175, FORD #385189-S100, CHRY #6031115

CL Part No: 910-1810, Pieces: 4



246-605

Std. Pkg. 25 pcs.

Flange Dia. 1/2"

GM & FORD 1979-on
Window Regulator Rivet
Grip Range 11/16-3/4
GM #12338153, 20184399, FORD #389268-S100

CL Part No: 910-1825, Pieces: 2



246-610

Std. Pkg. 25 pcs.

Dia. 1/4", Flange Dia. 1/2"

GM, FORD, CHRYSLER 1976-on
Window Regulator Rivet
Grip Range 33/64"-19/32"
GM #9437938, FORD #385323-S100, CHRY #6031091

CL Part No: 910-1820, Pieces: 3



246-612

Std. Pkg. 25 pcs.

Dia. 1/4", Flange Dia. 1/2"

FORD 1978-on, GM
Peel-Type Rivet
Grip Range 5/64"-7/64"; Recess Under Head, Aluminum
Rivet Steel Mandrel Attaches Outside Door Handle
Heat Shield Attachment
FORD #388047-S100, GM #14078435

CL Part No: 910-1805, Pieces: 2



246-614

Std. Pkg. 25 pcs.

Dia. 1/4", Flange Dia. 3/4"

ESCORT & LYNX 1981-on
Black Steel Rivet
Steel Mandrel Bumper Assembly
Grip Range 1/8"-1/4"
#388442-S100

CL Part No: 910-1815, Pieces: 2



246-616

Std. Pkg. 25 pcs.

Dia. 1/4", Flange Dia. 1/2"

FORD 1981-on
Black Peel-Type Aluminum Rivet
Steel Mandrel Door Handle Assembly
Grip Range 3/32"-1/8"
#388047-S102

CL Part No: 910-1800, Pieces: 2



247-300

Std. Pkg. 25 pcs.

Hole Dia. 13/64"

GM, VW, CHRYSLER, FORD
Plastic Rivet, 1/8-15/64 Grip
GM #20432975, VW #175-853-57701C,
CHRY #6503800, FORD #N804343S

CL Part No: 910-1850, Pieces: 3



247-301 Std. Pkg. 25 pcs.
Hole Dia. 1/4"
 GM, FORD, CHRYSLER
 Plastic Rivet, 5/32-13/32 Grip
 GM #14063981,
 FORD #N803043-S, CHRY #65600911
CL Part No: 910-1860, Pieces: 3



247-302 Std. Pkg. 25 pcs.
Hole Dia. 1/4"
 GM
 Plastic Rivet, 5/32-15/64 Grip
 GM #14070914



247-303 Std. Pkg. 25 pcs.
Hole Dia. 1/4"
 GM, FORD, CHRYSLER
 Plastic Rivet 5/32-13/32 Grip
 GM #10184895, FORD #N803862-S,
 CHRY #6501559, 6506007-AA



247-304 Std. Pkg. 25 pcs.
Hole Dia. 17/64"
 GM, VW
 Plastic Rivet 3/32-3/16 Grip
 GM #20433026
 VW #175-853-577A
CL Part No: 910-1870, Pieces: 3



247-305 Std. Pkg. 25 pcs.
Hole Dia. 17/64"
 GM
 Plastic Rivet 3/32-3/16 Grip
 #20421672, 15955172



247-306 Std. Pkg. 25 pcs.
Hole Dia. 13/64"
 GM, FORD
 Plastic Rivet 1/16-11/64 Grip
 GM #20423647, FORD #N804189-S
CL Part No: 910-1845, Pieces: 3



247-307 Std. Pkg. 25 pcs.
Hole Dia. 13/64"
 CHRYSLER
 Plastic Rivet 15/64-25/64 Grip
 #6500898
CL Part No: 910-1840, Pieces: 3



247-308 Std. Pkg. 25 pcs.
Dia. 3/16", Flange Dia. 9/16"
 FORD 1882-on
 Fascia Bumper Rivet
 Grip Range 3/8"-1/2"
 #388664-S100
CL Part No: 910-1890, Pieces: 3



247-310 Std. Pkg. 25 pcs.
Dia. 1/4", Flange Dia. 1/2"
 CHRYSLER, FORD, GM
 Black Nylon Blind Rivet
 Grip Range 5/32"-13/32"
 CHRY #6501559, 6506007-AA;
 FORD #N803862-S, GM #10184895
CL Part No: 910-1865, Pieces: 3



247-311 Std. Pkg. 25 pcs.
Dia. 3/16", Flange Dia. 7/16"
 FORD, GM
 Black Split-Type Aluminum Rivet
 Grip: 5/64"-15/64"
 FORD #N805592-S100, GM #25618730
CL Part No: 910-1885, Pieces: 2



247-312 Std. Pkg. 25 pcs.
Dia. 17/64", Flange Dia. 1/2"
 GM
 Black Nylon Blind Rivet
 Grip Range 3/32"-3/16"
 #15955172, 20421672
CL Part No: 910-1875, Pieces: 3



247-313 Std. Pkg. 25 pcs.
Dia. 5/32", Flange Size: 11/32"x5/8"
 FORD AEROSTAR 1986-on
 Cowl Vent Grille Retainer Rivet
 Grip Range 5/64"-13/32"
 #N804583-S
CL Part No: 910-1835, Pieces: 3



247-314

Std. Pkg. 25 pcs.

Dia. 1/4", Flange Dia. 21/32"

CHRYSLER
Black Nylon Blind Rivet
Grip Range 1/32"-3/16"
#4630660

CL Part No: 910-1855, Pieces: 2

239-494

Std. Pkg. 100 pcs.

Dia. 3/16"

Back-up Plate for 3/16 Rivets
Plated Steel

ALUMINUM RIVETS

RIVET OBTURATEUR ALUMINUM

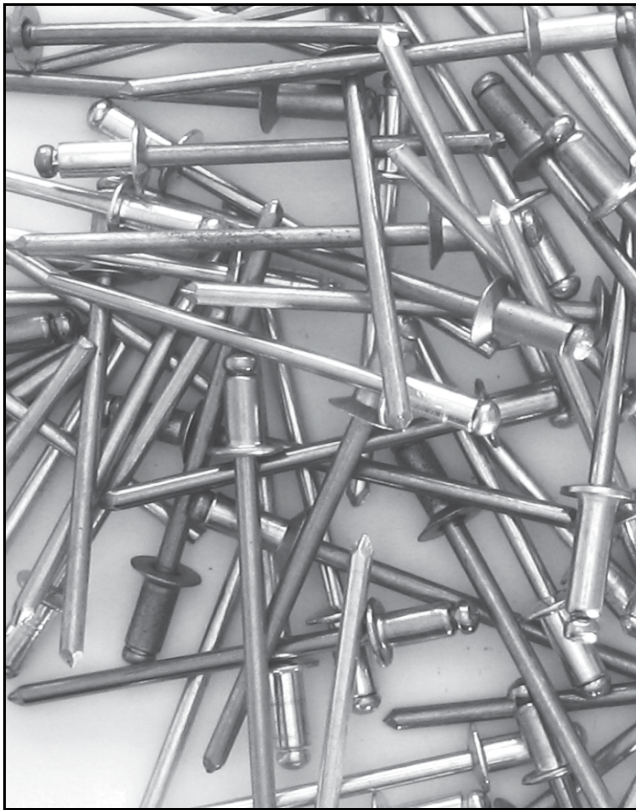

HOW TO MEASURE RIVETS

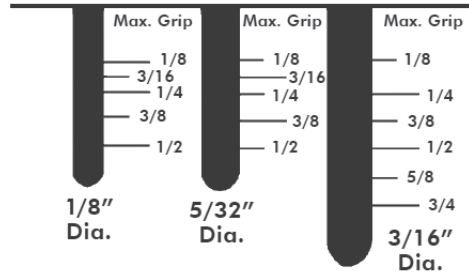

Rivet Length
measure to end
of rivet body.

Rivet Diameter		Drill	
Inch	Metric	Number	Size
3/32	2.4mm	#41	.096 - .100
1/8	3.2mm	#30	.129 - .133
5/32	4.0mm	#20	.160 - .164
3/16	4.8mm	#11	.192 - .196

Recommended
Hole
Sizes

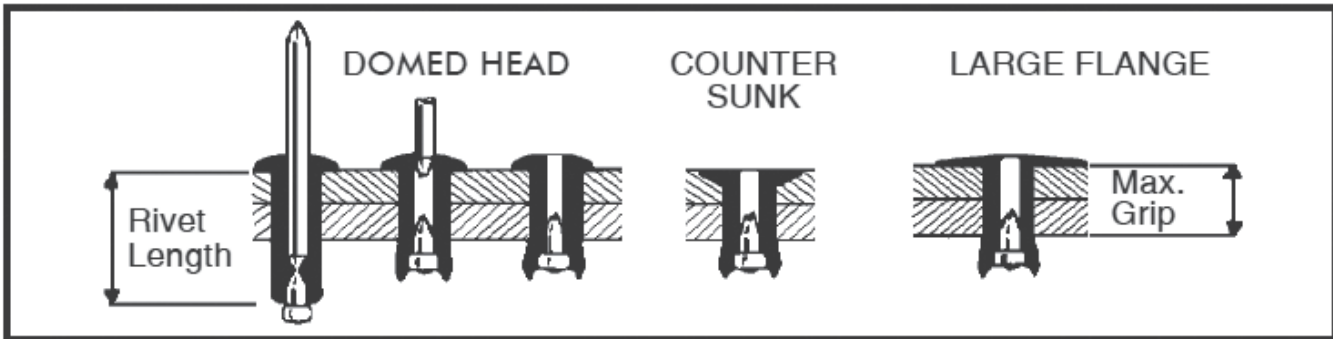

ALUMINUM RIVETS

RIVET OBTURATEUR ALUMINIUM

81

ALUMINUM RIVET - ALUMINUM MANDREL

RIVET EN ALUMINIUM - MANCHON DE RIVET EN ALUMINIUM

Stock	Other No.	Hang-up Box No.	Rivet Dia.	Grip Range	Head Type	Rivet Length
239-011	AA42D	239-611	1/8 (.125)	1/16 - 1/8	Domed	0.232
239-014	AA43D	239-614	1/8 (.125)	1/8 - 3/16	Domed	0.294
239-017	AA44D	239-617	1/8 (.125)	3/16 - 1/4	Domed	0.357
239-018	AA4LF	239-617	1/8 (.125)	3/16 - 1/4	L. Flange	0.357
239-023	AA46D	239-617	1/8 (.125)	5/16 - 3/8	Domed	0.481
239-026	AA48D	239-617	1/8 (.125)	3/8 - 1/2	Domed	0.625
239-038	AA56D	239-617	5/32(.156)	1/4 - 3/8	Domed	0.504
239-047	AA62D	239-647	3/16 (.188)	1/16 - 1/8	Domed	0.277
239-053	AA64LF	239-653	3/16 (.188)	1/8 - 1/4	Domed	0.402
239-056	AA66D	239-653	3/16 (.188)	1/4 - 3/8	Domed	0.527
239-057	AA66LF	239-653	3/16 (.188)	1/4 - 3/8	L. Flange	0.527
239-059	AA68D	239-653	3/16 (.188)	3/8 - 1/2	Domed	0.652
239-060	AA68LF	239-653	3/16 (.188)	3/8 - 1/2	L. Flange	0.652

ALUMINUM RIVET - STEEL MANDREL

RIVET EN ALUMINIUM - MANCHON DE RIVET EN ACIER

Stock	Other No.	Hang-up Box No.	Rivet Dia.	Grip Range	Head Type	Rivet Length
239-111	AS42D	239-711	1/8 (.125)	1/16 - 1/8	Domed	0.232
239-114	AS43D	239-714	1/8 (.125)	1/8 - 3/16	Domed	0.294
239-117	AS44D	239-717	1/8 (.125)	3/16 - 1/4	Domed	0.357
239-150	AS62D	239-750	3/16 (.188)	1/16 - 1/8	Domed	0.277
239-153	AS64D	239-753	3/16 (.188)	1/8 - 1/4	Domed	0.402
239-156	AS66D	239-753	3/16 (.188)	1/4 - 3/8	Domed	0.527
239-159	AS68D	239-753	3/16 (.188)	3/8 - 1/2	Domed	0.652
239-160	AS68LF	239-753	3/16 (.188)	3/8 - 1/2	L. Flange	0.652

STEEL RIVETS

RIVET OBTURATEUR ACIER

STEEL RIVET - STEEL MANDREL

RIVETS EN ACIER - MANCHON DE RIVET EN ACIER

Stock	Other No.	Hang-up Box No.	Rivet Dia.	Grip Range	Head Type	Rivet Length
239-210	SS42C	239-810	1/8 (.125)	1/16 - 1/8	Csk.	0.276
239-211	SS42D	239-811	1/8 (.125)	1/16 - 1/8	Domed	0.232
239-213	SS43C	239-813	1/8 (.125)	1/8 - 3/16	Csk.	0.316
239-214	SS43D	239-814	1/8 (.125)	1/8 - 3/16	Domed	0.294
239-216	SS44C	239-816	1/8 (.125)	3/16 - 1/4	Csk.	0.362
239-217	SS44D	239-817	1/8 (.125)	3/16 - 1/4	Domed	0.357
239-218	SS44LF	239-817	1/8 (.125)	3/16 - 1/4	L. Flange	0.357
239-223	SS46D	239-817	1/8 (.125)	5/16 - 3/8	Domed	0.481
239-226	SS48D	239-817	5/32(.156)	3/8 - 1/2	Domed	0.625
239-229	SS52D	239-817	5/32(.156)	1/16 - 1/8	Domed	0.254
239-235	SS54D	239-817	5/32(.156)	3/16 - 1/4	Domed	0.397
239-238	SS56D	239-817	5/32(.156)	1/4 - 3/8	Domed	0.504
239-250	SS62D	239-850	3/16 (.188)	1/16 - 1/8	Domed	0.277
239-253	SS64D	239-853	3/16 (.188)	1/8 - 1/4	Domed	0.402

STEEL RIVETS - STEEL MANDREL

RIVETS EN ACIER - MANCHON DE RIVET EN ACIER

Stock	Other No.	Hang-up Box No.	Rivet Dia.	Grip Range	Head Type	Rivet Length
239-256	SS66D	239-853	3/16 (.188)	1/4 - 3/8	Domed	0.527
239-257	SS66LF	239-853	3/16 (.188)	1/4 - 3/8	L. Flange	0.527
239-259	SS68D	239-853	3/16 (.188)	3/8 - 1/2	Domed	0.652
239-260	SS68LF	239-853	3/16 (.188)	3/8 - 1/2	L. Flange	0.652
239-262	SS610D	239-853	3/16 (.188)	1/2 - 5/8	Domed	0.777
239-263	SS610LF	239-853	3/16 (.188)	1/2 - 5/8	L. Flange	0.777
239-265	SS612D	239-853	3/16 (.188)	5/8 - 3/4	Domed	0.902
239-266	SS612LF	239-853	3/16 (.188)	5/8 - 3/4	L. Flange	0.902

STAINLESS RIVETS - STEEL MANDREL

RIVETS EN ACIER - MANCHON DE RIVET EN ACIER

Stock	Other No.	Hang-up Box No.	Rivet Dia.	Grip Range	Head Type	Rivet Length
5195-111	STS42D	239-853	1/8 (.125)	1/16 - 1/8	Domed	0.232
5195-114	STS43D	239-853	1/8 (.125)	1/8 - 3/16	Domed	0.294
5195-117	STS44D	239-853	1/8 (.125)	3/16 - 1/4	Domed	0.357
5195-123	STS46D	239-853	1/8 (.125)	5/16 - 3/8	Domed	0.481
5195-126	STS48D	239-853	1/8 (.125)	3/8 - 1/2	Domed	0.625
5195-150	STS62D	239-853	3/16 (.188)	1/16 - 1/8	Domed	0.277
5195-153	STS64D	239-853	3/16 (.188)	1/8 - 1/4	Domed	0.402
5195-156	STS66D	239-853	3/16 (.188)	1/4 - 3/8	Domed	0.527
5195-159	STS68D	239-853	3/16 (.188)	3/8 - 1/2	Domed	0.652

STAINLESS RIVETS - STAINLESS MANDREL

RIVETS EN ACIER - MANCHON DE RIVET EN ACIER INOXYDABLE

Stock	Other No.	Hang-up Box No.	Rivet Dia.	Grip Range	Head Type	Rivet Length
5195-211	STST42D	239-853	1/8 (.125)	1/16 - 1/8	Domed	0.232
5195-214	STST43D	239-853	1/8 (.125)	1/8 - 3/16	Domed	0.294
5195-217	STST44D	239-853	1/8 (.125)	3/16 - 1/4	Domed	0.357
5195-223	STST46D	239-853	1/8 (.125)	5/16 - 3/8	Domed	0.481
5195-226	STST48D	239-853	1/8 (.125)	3/8 - 1/2	Domed	0.625
5195-250	STST62D	239-853	3/16 (.188)	1/16 - 1/8	Domed	0.277
5195-253	STST64D	239-853	3/16 (.188)	1/8 - 1/4	Domed	0.402
5195-256	STST66D	239-853	3/16 (.188)	1/4 - 3/8	Domed	0.527
5195-259	STST68D	239-853	3/16 (.188)	3/8-1/2	Domed	0.627



247-145

Std. Pkg. 40 pcs. (One size)

Hog Rings

Hog Rings
To attach seat covers to cushions and seat bottoms - also cushion spring clips
Medium .80" Wire Dia.

CL Part No: 910-1320, Pieces: 20

247-887

Std. Pkg. 25 pcs.

Lock Washer

Lock Washer
O.D. 29/32", Bolt size: 9/16"

NOT ACTUAL SIZE



247-899

Std. Pkg. 25 pcs.

8" Releasable Cable Strap

HONDA, MAZDA, TOYOTA
8" Releasable Cable Strap
UNIVERSAL

CL Part No: 910-0950, Pieces: 2



247-900

Std. Pkg. 25 pcs.

5-3/4" Releasable Cable Strap

HONDA, MAZDA
5-3/4" Releasable Cable Strap
HONDA #90672-SA0-0030, MAZDA #9928-91-053

CL Part No: 910-0955, Pieces: 4

TOOLS

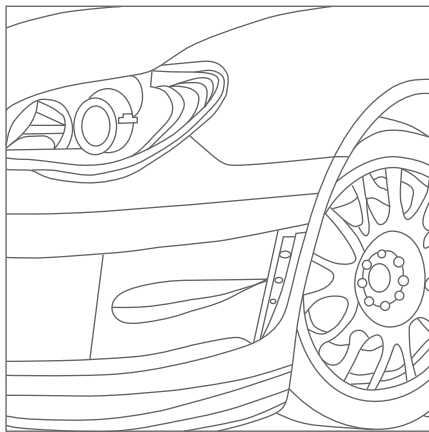
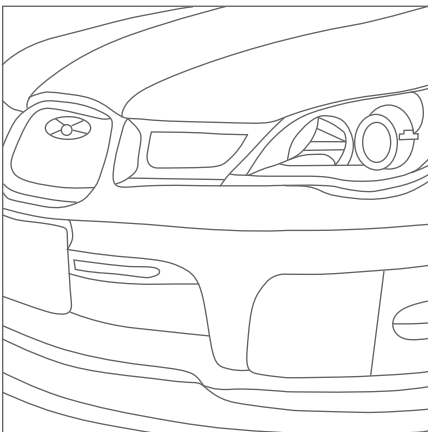
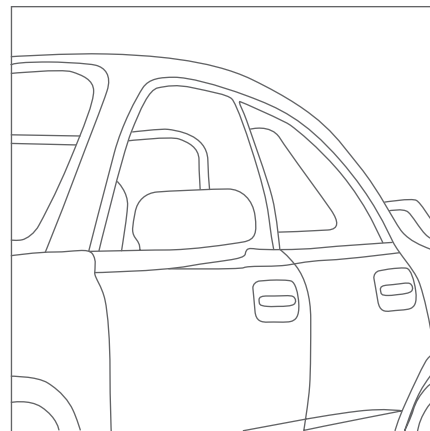
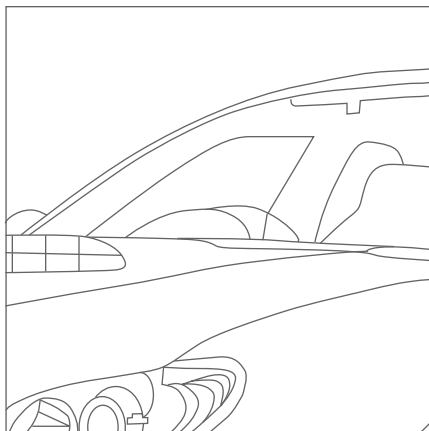

OUTILS

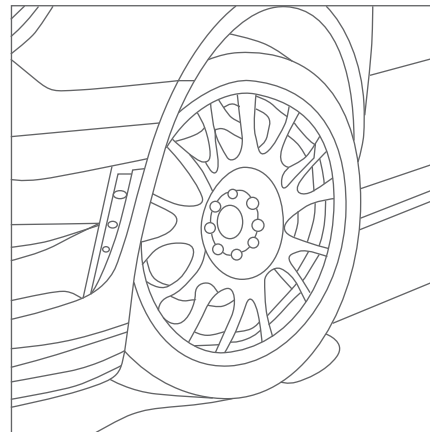

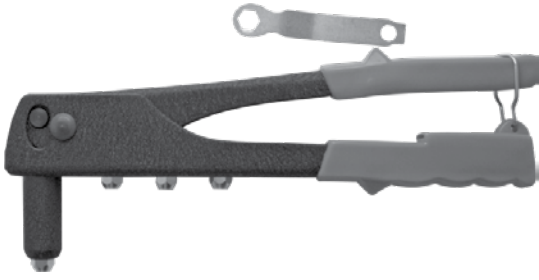

239-500

Individually Packaged

Medium Duty Riveter

Medium Duty Riveter
Sets 3/32, 1/8, 5/32 and 3/16 diameter rivets.



239-501

Individually Packaged

Professional Blind Riveter

Professional Blind Riveter
Sets 3/32, 1/8 and 5/32 and 3/16 diameter rivets.



246-500

Individually Packaged

Windshield Moulding Release Tool

Windshield Moulding Release Tool
For removing all windshield mouldings.
Features angled shaft and beveled front edges
for easy entry.



246-895

Individually Packaged

Window Handle Removing Tool

Window Handle Removing Tool
For removing inside door and window handles.



247-299

Individually Packaged

Trim Pad Release Tool

Trim Pad Release Tool
Designed to remove plastic trim pad fasteners
without damaging the fastener or backboard.



249-120

Individually Packaged

Utility Scissors

Utility Scissors
Professional quality features stainless steel blades with long-lasting
edges and high-impact, man-size plastic handles.
Available while quantities last until September 15, 2018



249-124

Individually Packaged

Angled Head Utility Scraper

Angled Head Utility Scraper
Ideal for trimming, cutting, splicing, scraping
paint or stickers.



249-125

Individually Packaged

Safety Scraper

Safety Scraper
Ideal for trimming, cutting, splicing, scraping
paint or stickers.

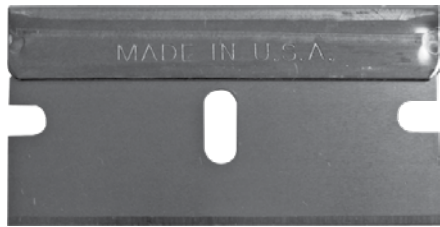

249-126

Standard Package 10 Blades

Replacement Blades

Replacement Blades
Single edge, industrial duty replacement blades
for No. 249-125 scraper.



249-127

Quantity: 100 Blades per Pack

Plastic Scraper Blades

Plastic Scraper Blades
For cleaning windows coated with sun film
or laminated glass.
Fits all standard razor blade scrapers.



249-130

Individually Packaged

Utility Shears

Utility Shears
Professional quality, stainless steel blades with long-lasting edges
High-impact handles with safety lock.
Available while quantities last until September 15, 2018



997-594

Standard Package 5

Double-Ended Panel Drill Bit

Double-Ended Panel Drill Bits
Dia. 1/8", Length: 2"

NUTS
BOLTS
WASHERS
GROMMETS

RIVETS
FASTENERS
MOULDINGS
CLIPS

STORAGE & ASSORTMENTS

GM
FORD
CHRYSLER

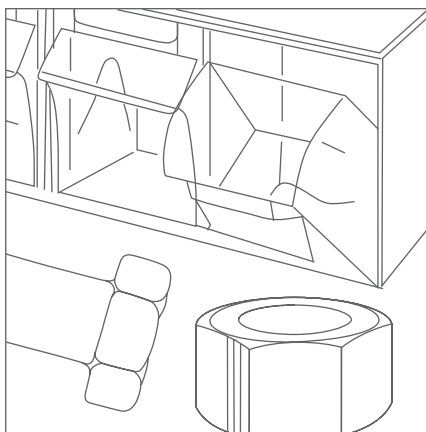
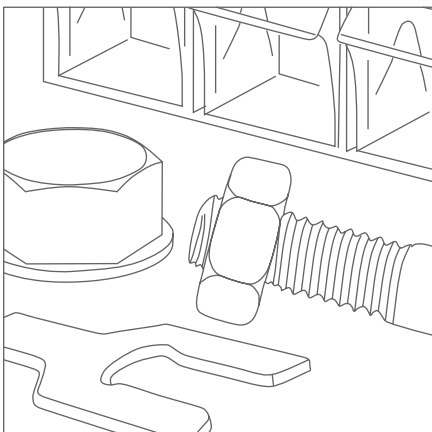
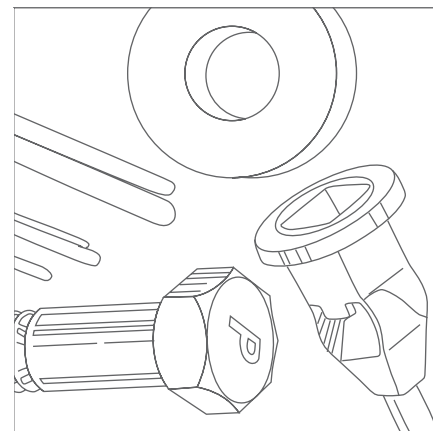
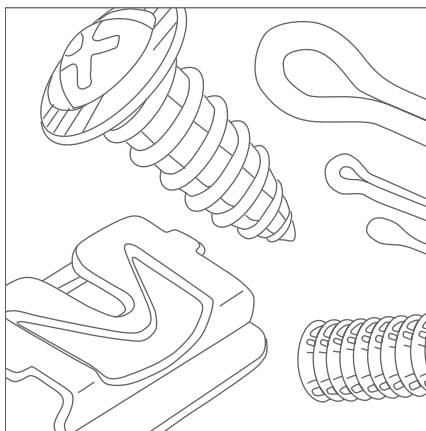

ECROUS
BOULONS
RONDELLES
OUILLETS

RIVETS
ATTACHES
MOULURES
PINCES

CABINETS ET ASSORTIMENTS

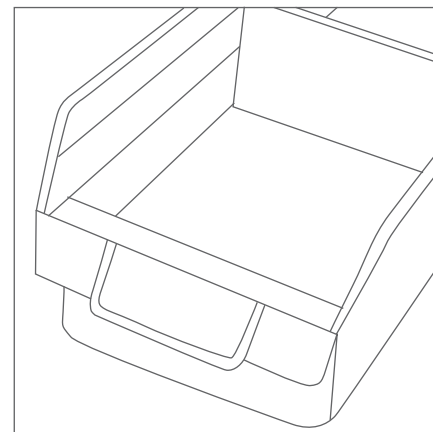



STAX-SIX CABINET

The modern method of stocking Master Assortments. Each steel STAX-SIX Cabinet holds six Master Assortments in its own rigid drawer slides.



STAX-RAX No. 022-091

- Heavy gauge steel construction.
- Baked black enamel finish.
- Rigid drawer slide.
- No-spill feature.

Stax-Six Cabinet No. 022-091

Size: 15-1/4" W x 15-1/2" H x 11-3/4" D

MASTER ASSORTMENTS

(Assortments or Assortment Drawers NOT included.)

020-605		
Contains 138 pcs.		
VACUUM CONNECTORS		
Stock #.	Size	Qty.
904-901	1/8 STR.	5
904-902	3/16 STR.	5
904-920	3/16 RESTRICTOR	2
904-922	1/8 TEE	5
904-923	3/16 TEE	5
904-924	1/4 TEE	5
904-932	3/16x1/4x3/16 TEE	2
904-939	3/8x3/8x1/4 TEE	2
904-941	3 WAY 3/16	5
904-960	4 WAY 3/16	2
904-965	5 WAY 3/16	2
904-975	UNIVERSAL TEE	3
904-976	UNIVERSAL STR.	5
904-990	1/8 CAP	25
904-991	3/16 CAP	25
904-992	1/4 CAP	25
904-993	5/16 CAP	10
904-994	3/8 CAP	5

020-611		
Contains 68 Bolts & 68 Nuts		
BUMPER BAR BOLTS		
Stock #.	Size	Qty.
245-154	5/16-18 x 1-1/4	4
245-160	3/8-16 x 3/4	6
245-161	3/8-16 x 3/4	6
245-164	3/8-16 x 1	6
245-165	3/8-16 x 1	6
245-167	3/8-16 x 1-1/4	6
245-172	7/16-14 x 1-1/4	4
245-173	7/16-14 x 1-1/2	8
245-175	7/16-14 x 2	3
245-182	1/2-13 x 1-1/4	3
245-183	1/2-13 x 1-1/2	3
245-184	1/2-13 x 1-3/4	2
245-916	5/16-18	4
245-918	3/8-16	30
245-920	7/16-14	14
245-922	1/2-13	8
245-220	M8 x 25mm	6
245-221	M8 x 30mm	6
700-008	M8	12

020-612				
Contains 937 Screws				
TAPPING SCREWS Pan, Oval and Hex - Slot				
	Stock #.	Size	Qty.	
Pan	205-085	6 x 3/8	125	
	205-087	6 x 1/2	100	
	205-089	6 x 3/4	75	
	205-091	6 x 1	50	
	205-135	8 x 3/8	75	
	205-137	8 x 1/2	50	
	205-139	8 x 3/4	50	
	205-141	8 x 1	25	
	205-189	10 x 1/2	50	
	205-191	10 x 3/4	25	
Oval	205-193	10 x 1	25	
	205-280	14 x 1	7	
	206-089	6 x 3/4	75	
	206-091	6 x 1	50	
	206-139	8 x 3/4	50	
	206-141	8 x 1	25	
	206-191	10 x 3/4	40	
	Hex	213-137	8 x 1/2	20
		213-191	10 x 3/4	15
		213-280	14 x 1	5

020-615		
Contains 280 Screws - 125 Washers		
TAPPING SCREWS Hexagon Head - Fender Washers		
Stock #.	Size	Qty.
162-394	3/4 O.D. x 3/16 B.S.	25
162-395	1-1/4 O.D. x 1/4 B.S.	25
162-396	1 O.D. x 5/16 B.S.	25
162-397	1-1/4 O.D. x 5/16 B.S.	25
162-398	1-1/2 O.D. x 3/8 B.S.	25
213-137	8 x 1/2	25
213-187	10 x 3/8	20
213-189	10 x 1/2	25
213-190	10 x 5/8	20
213-191	10 x 3/4	20
213-276	14 x 1/2	25
213-277	14 x 5/8	20
213-278	14 x 3/4	25
213-280	14 x 1	20
213-282	14 x 1-1/4	15
213-442	5/16 x 3/4	15
213-444	5/16 x 1	20
213-448	5/16 x 1-1/2	10
213-489	3/8 x 1	10
213-493	3/8 x 1-1/2	10

020-617		
Contains 1000 Screws		
SPEE-DRILL SCREWS		
Stock #.	Size	Qty.
222-085	6 x 3/8	150
222-111	7 x 1/2	250
222-137	8 x 1/2	300
222-189	10 - 24 x 1/2	200
222-191	10 - 24 x 3/4	100

Also includes Magnetic Chuck (1/4Hx1-7/8)

020-619		
Contains 1200 Washers		
S.A.E. WASHERS		
Stock #.	Size	Qty.
154-006	1/8	100
154-010	3/16	200
154-014	1/4	200
154-016	5/16	200
154-018	3/8	200
154-020	7/16	100
154-022	1/2	100
154-023	9/16	50
154-024	5/8	25
154-026	3/4	10
154-028	7/8	10
154-030	1	5

020-618 Contains 1230 Pins

COTTER PINS

Stock #.	Size	Qty.
165-043	1/16 x 1/2	75
165-045	1/16 x 3/4	100
165-047	1/16 x 1	100
165-049	1/16 x 1-1/4	75
165-051	1/16 x 1-1/2	75
165-089	3/32 x 3/4	75
165-091	3/32 x 1	125
165-093	3/32 x 1-1/4	125
165-095	3/32 x 1-1/2	75
165-098	3/32 x 2	50
165-139	1/8 x 3/4	35
165-141	1/8 x 1	50
165-143	1/8 x 1-1/4	75
165-145	1/8 x 1-1/2	50
165-147	1/8 x 1-3/4	20
165-148	1/8 x 2	25
165-171	5/32 x 1-1/2	40
165-174	5/32 x 2	30
165-197	3/16 x 1-1/2	15
165-200	3/16 x 2	15

020-622 Contains 155 Screws,
288 Nuts, 924 Washers, 145 Bolts.

BOLTS, NUTS, SCREWS

Cap Screws (U.N. C.), Nuts (U.N.C.), Lock Washers,
S.A.E. Washers, Machine Screws (Round Head).

	Stock #.	Size	Qty.
Cap Screws	075-307	1/4 x 3/4	38
	075-309	1/4 x 1	35
	075-442	5/16 x 3/4	25
	075-444	5/16 x 1	25
	075-489	3/8 x 1	17
	075-493	3/8 x 1-1/2	15
Nuts	083-014	1/4-20	61
	083-016	5/16-18	46
	083-018	3/8-16	36
	184-010	10-24	60
	184-014	1/4-20	85
Lock Washers	157-014	1/4	210
	157-016	5/16	200
	157-018	3/8	139
S.A.E. Washers	154-014	1/4	159
	154-016	5/16	133
	154-018	3/8	83
Machine Screws	1741-193	10-24 x 1	60
	1741-307	1/4-20 x 3/4	44
	1741-309	1/4-20 x 1	41

020-623 Contains 816 Screws, 816 Nuts

MACHINE SCREWS Round & Oval Head - Phillips

	Stock #.	Size	Qty.
Round	173-085	6-32 x 3/8	30
	173-135	8-32 x 3/8	30
	173-137	8-32 x 1/2	30
	173-139	8-32 x 3/4	30
	173-141	8-32 x 1	30
	173-217	10-32 x 1/2	30
	173-219	10-32 x 3/4	30
	173-189	10-24 x 1/2	23
	173-305	1/4-20 x 1/2	23
	173-307	1/4-20 x 3/4	12
	173-309	1/4-20 x 1	23
	175-137	8-32 x 1/2	30
Oval	175-139	8-32 x 3/4	30
	175-217	10-32 1/2	30
	175-191	10-24 x 3/4	12
	184-006	6-32	60
Nuts	184-008	8-32	180
	184-011	10-32	90
	184-010	10-24	35
	184-014	1/4-20	58

020-644 Contains 421
Formed and Flat Types

SPEED NUTS

Stock #.	Size	Qty.
240-089	6/32	25
240-091	6/32	35
240-100	8/32	25
240-101	8/32	25
240-108	No.8	32
240-120	10-24	50
240-127	N.10	40
240-159	1/4-20	25
240-226	No.8	15
240-228	No.8	18
240-232	No.8	15
240-242	No.8	20
240-243	10-24	15
240-247	No.10	14
240-250	No.10	23
240-263	1/4-20	10
240-266	No.12 U	14
240-267	No.14	10
240-268	No.14	10

020-646 Contains 208
U.N.F. Fine Thread

CAP SCREWS

Stock #.	Size	Qty.
076-305	1/4 x 1/2	13
076-307	1/4 x 3/4	17
076-309	1/4 x 1	20
076-313	1/4 x 1-1/2	17
076-316	1/4 x 2	7
076-442	5/16 x 3/4	17
076-444	5/16 x 1	20
076-446	5/16 x 1-1/4	17
076-448	5/16 x 1-1/2	15
076-451	5/16 x 2	7
076-489	3/8 x 1	13
076-493	3/8 x 1-1/2	13
076-496	3/8 x 2	7
076-534	7/16 x 1	5
076-538	7/16 x 1-1/2	5
076-541	7/16 x 2	4
076-583	1/2 x 1-1/2	4
076-586	1/2 x 2	3
076-672	5/8 x 1-1/2	2
076-675	5/8 x 2	2

020-661 Contains 350 Screws

CHROME TRIM SCREWS

Stock #.	Size	Qty.
229-806	6 x 3/4	15
229-811	8 x 3/4	40
229-815	8 x 1	40
229-819	8 x 1-1/4	20
229-833	10 x 3/4	30
229-837	10 x 1	30
229-985	8 x 3/4	20
229-986	8 x 1	20
230-203	4.2 x 13 MM	5
230-205	4.2 x 20 MM	5
230-206	4.2 x 20 MM	10
230-207	4.2 x 20 MM	10
230-301	4.2 x 8 MM	30
230-302	4.2 x 12 MM	30
230-304	4.2 x 16 MM	30
230-305	4.2 x 20 MM	15

020-662 Contains 350 Screws

BLACK TRIM SCREWS

Stock #.	Size	Qty.
229-401	8 x 1/2	10
229-402	8 x 5/8	10
229-403	8 x 3/4	25
229-405	8 x 1	25
229-407	8 x 1-1/4	10
229-414	10 x 3/4	10
229-416	10 x 1	10
229-849	8 x 5/8	12
229-851	8 x 3/4	25
229-855	8 x 1	25
229-883	10 x 3/4	12
229-887	10 x 1	12
229-911	8 x 3/4	25
229-915	8 x 1	25
229-919	8 x 1-1/4	15
229-933	10 x 3/4	12
229-937	10 x 1	12
229-945	10 x 1-1/2	10
229-962	8 x 1/2	10
229-968	8 x 3/4	15
229-972	8 x 1	10
229-980	10 x 3/4	5
229-982	10 x 1	5
229-987	8 x 3/4	5
229-988	8 x 1	5
229-303	4.2 x 12	5
229-306	4.2 x 20	5

020-667 Contains 1200 Pieces

BLIND RIVETS

Stock #.	Size	Qty.
239-492	3/16	50
239-493	1/8	100
239-494	3/16	50
239-611	1/8 x 1/8	75
239-617	1/8 x 1/4	135
239-653	3/16 x 1/4	35
239-714	1/8 x 3/16	75
239-717	1/8 x 1/4	75
239-750	3/16 x 1/8	35
239-753	3/16 x 1/4	35
239-811	1/8 x 1/8	135
239-814	1/8 x 1/16	200
239-817	1/8 x 1/4	200

020-668 Contains 395 Screws

'DRILL-X' SELF-TAPPING SCREWS

Stock #.	Size	Qty.
232-035	8 x 1	30
232-038	10 x 5/8	10
232-039	10 x 3/4	25
232-071	8 x 1/2	12
232-073	8 x 3/4	25
232-074	8 x 1	35
232-078	10 x 1/2	13
232-080	10 x 3/4	20
232-082	10 x 1	25
232-084	10 x 1-1/2	35
232-086	12 x 3/4	10
232-088	12 x 1-1/2	15
232-089	12 x 2	10
232-092	14 x 3/4	20
232-093	14 x 1	15
232-095	14 x 1-1/2	15
232-097	14 x 2	15

020-669

Contains 240 Screws

6-LOBE TRIM SCREWS

Stock #.	Size	Qty.
231-205	4.2 x 20mm	40
231-206	4.2 x 20mm	40
231-209	4.2 x 30mm	20
231-210	4.2 x 30mm	20
231-213	4.2 x 40mm	10
231-219	4.2 x 55mm	10
231-251	4.2 x 20mm	35
231-252	4.2 x 20mm	35
231-257	4.2 x 35mm	15
231-264	4.2 x 50mm	15

020-674

Contains 325 Pieces

'PALNUT' FASTENERS

Stock #.	Size	Qty.
242-016	5/16-24	13
242-018	3/8-24	10
242-108	8-32	13
242-110	10-24	20
242-114	1/4-20	20
242-116	5/16-18	10
242-206	1/8	8
242-208	5/32	8
242-210	3/16	15
242-214	1/4	13
242-216	5/16	10
242-314	1/4	15
242-316	5/16	15
242-318	3/8	15
242-406	1/8	10
242-408	5/32	10
242-410	3/16	15
242-413	.240	10
243-004	M4	10
243-106	M6	13
243-204	M4 SELF-THRDG.	13
243-306	M6	13
243-308	M8	13
243-310	M10	10
243-404	4mm	13
243-405	5mm	10

020-675

Contains 50 Screws & Nuts

HEADLAMP SCREWS General Motors

Stock #.	Make	Qty.
248-010	GM	2
248-015	GM	2
248-016	GM	2
248-020	GM	6
248-025	GM	3
248-026	GM	2
248-030	GM	6
248-031	GM	2
248-032	GM	3
248-033	GM	3
248-035	GM	2
248-040	GM	2
248-045	GM	3
248-050	GM	6
248-055	GM	2
248-060	GM	3

020-676

Contains 45 Screws & Nuts

HEADLAMP SCREWS Chrysler and Ford

Stock #.	Make	Qty.
248-110	FORD	4
248-115	FORD	5
248-116	FORD	4
248-120	FORD	4
248-121	FORD	4
248-125	FORD	6
248-210	CHRYSLER	6
248-215	CHRYSLER	2
248-220	CHRYSLER	5
248-225	CHRYSLER	5

020-678

Contains 295 Grommets & Nuts

ANCHOR GROMMETS AND NUTS

Stock #.	Make	Qty.
247-610	CHRYSLER	10
247-611	CHRYSLER	10
247-620	GM	10
247-625	FORD	10
247-630	GM	10
247-650	GM	20
247-660	GM	20
247-665	GM	10
247-670	GM	10
247-710	GM	20
247-715	GM	20
247-720	GM	10
247-730	FORD	10
247-735	GM	10
247-811	GM	15
247-812	GM	10
247-815	GM	20
247-820	GM	15
247-826	GM	20
247-830	GM	20
247-840	LIC. PLATE	15

020-679

Contains 150 Fasteners

TRIM FASTENERS General Motors

Stock #.	Make	Qty.
247-012	GM	5
247-053	GM	5
247-056	GM	5
247-061	GM	5
247-080	GM	10
247-082	GM	5
247-085	GMC TRUCK	5
247-095	GM	5
247-101	CHRY, VW	5
247-150	GM	10
247-210	GM	10
247-211	GM, FORD	20
247-212	GM	10
247-215	GM/CHRY/FORD	15
247-216	GM	10
247-222	GM/FORD	5
247-235	GM/FORD	5
247-248	GM	5
247-249	GM	5
247-250	GM	5

020-680

Contains 150 Fasteners

TRIM FASTENERS Chrysler and Ford

Stock #.	Make	Qty.
247-025	CHRYSLER	5
247-038	FORD	5
247-052	FORD	5
247-055	FORD	15
247-062	FORD	10
247-065	FORD	5
247-110	FORD	5
247-136	CHRYSLER	5
247-165	FORD	10
247-211	GM, FORD	20
247-215	GM, CHRY, FORD	20
247-230	GM, FORD	5
247-231	FORD	5
247-232	FORD	5
247-236	CHRYSLER	5
247-237	CHRYSLER	5
247-238	CHRYSLER	5
247-245	FORD, CHRY	5
247-252	FORD	5
247-253	FORD	5

020-681

Contains 125 Clips

REVEAL WINDSHIELD CLIPS

Stock #.	Make	Qty.
246-409	GM	5
246-410	GM	6
246-411	GM	6
246-412	FORD, DATSUN	6
246-413	CHRYSLER	6
246-414	FORD	6
246-415	FORD	6
246-416	CHRYSLER	5
246-417	GM	6
246-418	GM	6
246-419	GM	6
246-420	GM	6
246-425	GM	15
246-426	FORD	6
246-427	FORD	6
246-428	FORD	5
246-429	FORD	5
246-435	CHRYSLER	6
246-436	CHRYSLER	6
246-438	CHRYSLER	6

020-682

Contains 100 Pieces

TRIM FASTENERS IMPORT

Stock #.	Make	Qty.	Stock #.	Make	Qty.
246-350	VOLVO	2	247-491	IMPORTS	5
246-351	VW	2	247-493	TOYOTA	3
246-352	AUDI/VW	2	247-494	NISSAN	3
246-353	BMW	1	247-850	HONDA/TOYOTA	5
246-354	VOLVO	2	247-851	HONDA/NISS/TOYOYA	5
246-355	VOLVO	1	247-852	NISSAN/TOYOTA	5
246-356	VOLVO	1	247-853	HONDA	3
246-357	VOLVO	1	247-854	HONDA	3
246-358	TOYOTA	3	247-855	TOYOTA	3
246-359	TOYOTA	1	247-856	HONDA/MAZDA/NISSAN	5
246-360	HONDA	2	247-857	HONDA	3
247-069	TOYOTA	3	247-858	MERC.	3
247-073	HONDA	3	247-859	BMW	1
247-074	TOYOTA	3	247-860	TOYOTA	2
247-075	NISSAN	3			
247-076	VOLVO	3			
247-077	HONDA	3			
247-308	FORD	5			
247-490	IMPORTS	10			

020-691 Contains 150 Bolts

BODY BOLTS

Stock #.	Size	Qty.
245-322	M6 x 22mm	8
245-325	M6 x 1.0 x 30	8
245-400	M4.2 x 20	15
245-405	M6.1.0 x 20	8
245-407	M6 x 1.0 x 25	8
245-420	M6.3 x 20mm	8
245-424	M6.3 X 1.0 x 25	8
245-425	M6.3 x 25mm	8
245-440	M8 x 1.25 x 30	8
245-450	M10 x 1.5 x 40mm	5
245-505	M6 x 1.0 x 20	7
245-507	M6 x 1.0 x 25	8
245-510	M6 x 1.0 x 35	5
245-525	M8 x 25mm	8
245-527	M8 x 1.25 x 30	8
245-610	1/4-20 x 1	10
245-615	5/16-18 x 7/8	5
245-616	5/16-18 x 1	5
245-620	3/8-16 x 1	5
245-630	3/8-16 x 1-1/2	5

020-692 Contains 100 Nuts

'U' NUTS'

Stock #.	Size	Qty.
240-614	1/4-20	5
240-615	1/4-20	5
240-616	5/16-18	10
240-617	5/16-18	5
240-618	3/8-16	5
240-619	3/8-16	10
240-706	# 6	2
240-708	# 8	2
240-709	# 8	3
240-710	# 10	3
240-714	# 14	3
240-715	# 14	2
241-604	M4 x .7	2
241-605	M4 x .7	3
241-606	M6 x 1.0	5
241-607	M6 x 1.0	5
241-608	M8 x 1.25	10
241-609	M8 x 1.25	10
241-610	M10 x 1.5	5
241-612	M6.3 x 1.0	5

020-693 Contains 150 Rivets

'PLASTI-RIVETS'

Stock #.	Size	Qty.
247-300	5mm x 6mm	10
247-301	6.3 mm x 10mm	10
247-302	6.3mm x 6mm	10
247-303	6.3mm x 10mm	10
247-304	6.6mm x 5mm	10
247-305	6.6mm x 5mm	10
247-306	5mm x 4.5mm	10
247-307	5mm x 10mm	10
247-401	GM	5
247-402	GM	5
247-403	GM	5
247-405	GM	5
247-406	GM, FORD	5
247-407	GM	5
247-411	GM	5
247-462	FORD	10
247-464	FORD	5
247-466	FORD	10
247-467	FORD	5
247-468	FORD	5

020-725 Contains 562 Cap Screws and Nuts

METRIC CAP SCREWS and NUTS

Stock #.	Size	Qty.
608-139	M4 x 16	25
608-198	M5 x 12	25
608-201	M5 x 16	30
608-203	M5 x 20	30
608-205	M5 x 25	25
608-267	M6 x 12	20
608-270	M6 x 16	25
608-272	M6 x 20	25
608-274	M6 x 25	25
608-276	M6 x 30	15
608-277	M6 x 35	5
608-279	M6 x 45	5
670-004	M4	25
670-005	M5	110
670-006	M6	112
700-004	M4	20
700-005	M5	20
700-006	M6	20

020-726 Contains 186 Cap Screws and Nuts

METRIC CAP SCREWS and NUTS

Stock #.	Size	Qty.
608-311	M8 x 12	8
608-314	M8 x 16	9
608-316	M8 x 20	10
608-318	M8 x 25	10
608-320	M8 x 30	8
608-322	M8 x 40	6
608-324	M8 x 50	4
608-326	M8 x 60	3
608-328	M8 x 70	3
608-370	M10 x 30	6
608-372	M10 x 40	6
608-374	M10 x 50	4
608-376	M10 x 60	3
608-378	M10 x 70	3
670-008	M8	61
670-010	M10	22
700-008	M8	10
700-010	M10	10

020-730 Contains 130 Cap Screws and Nuts

METRIC CAP SCREWS and NUTS
Fine and Extra Fine Thread

Stock #.	Size	Qty.
610-366	M10 x 1.0 x 20mm	4
610-368	M10 x 1.0 x 25mm	4
610-372	M10 x 1.0 x 40mm	4
610-374	M10 x 1.0 x 50mm	4
610-414	M12 x 1.25 x 30mm	3
610-416	M12 x 1.25 x 40	3
610-418	M12 x 1.25 x 50mm	3
670-750	M10 x 1	16
670-765	M12 x 1.25	9
609-320	M8 x 1.0 x 30mm	5
609-324	M8 x 1.0 x 50mm	5
609-368	M10 x 1.25 x 25mm	5
609-370	M10 x 1.25 x 30mm	5
609-372	M10 x 1.25 x 40mm	5
609-374	M10 x 1.25 x 50mm	5
609-416	M12 x 1.5 x 40mm	5
609-418	M12 x 1.5 x 50mm	5
670-208	M8 x 1	10
670-210	M10 x 1.25	20
670-212	M12 x 1.5	10

020-688 Contains 100 Clips

MOUDLING CLIPS

Stock #.	Make	Qty.
246-112	UNIVERT	6
246-120	UNIVERT	6
246-122	UNIVERT	6
246-124	UNIVERT	6
246-126	UNIVERT	6
246-218	GM	6
246-222	FORD	6
246-226	FORD	6
246-228	FORD	6
246-230	CHRY	6
246-324	UNIVER	6
246-400	UNIVER	6
246-403	FORD	10
246-405	CHRY	6
246-407	FORD	6

020-727 Contains 1000 Flat, Lock and Spring Washers

METRIC WASHERS

Stock #.	Size	Qty.
730-004	4mm	100
730-005	5mm	100
730-006	6mm	100
730-008	8mm	75
730-010	10mm	50
SPC002246	M4	25
SPC002245	M5	25
SPC002247	M6	25
SPC002244	M8	25
SPC002248	M10	25
740-004	4mm	100
740-005	5mm	100
740-006	6mm	125
740-008	8mm	75
740-010	10mm	50

BOLT BINS

Store your Cap Screws, Nuts and other fasteners in these modern, all-steel 'Papco' Bolt Bins. Every item is easy to see - your stock is kept clean, neat and always available.

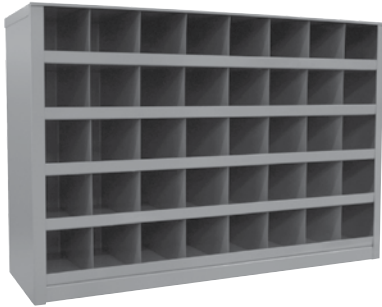

022-017

40 Bins

BOLT BINS (EMPTY)

Bolt Bins (empty)
36" Wide x 24" High x 12" Deep
Size: 4-1/2 x 4-1/2 x 12

022-018

42 Bins

BOLT BINS (EMPTY)

Bolt Bins (empty)
36" Wide x 42" High x 12" Deep
Size: 5-3/8 x 5-7/16 x 12

022-019

(Base not included) 72 Bins

BOLT BINS (EMPTY)

Bolt Bins (empty)
36" Wide x 42" High x 12" Deep
Size: 4-1/2 x 4-1/2 x 12

OPTIONAL STEEL DOORS

with Chrome Handles and Magnetic Catches.
No. 022-023 for Bolt Bin No. 022-017
No. 022-025 for Bolt Bin No. 022-018 and 019

HEAVY GAUGE STEEL

Welded Construction.

'SAFETY' BIN LIPS

Avoid Spillage.

BAKED FINISH

OPTIONAL STEEL BASE

4 Inches High, Black Finish.

022-027 Base fits either model.

BULK BINS

Durable Polypropylene, coloured bins are stackable and can be divided to hold more than one part.

Clear, plastic tilt-out bins in a stackable plastic cabinet.

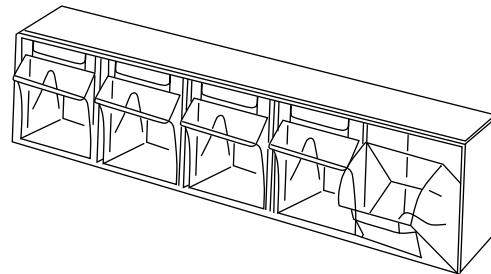
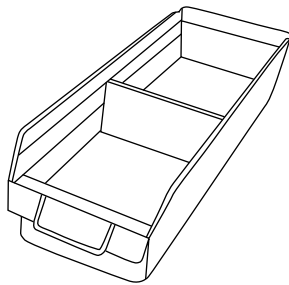

022-263 to 022-271

Standard Package 12 Bins

BULK BINS

Stock #.	Colour	W	D	W
022-263	Blue	6-5/8"	18"	4"
022-264	Red	6-5/8"	18"	4"
022-265	Yellow	6-5/8"	18"	4"
022-266	Green	6-5/8"	18"	4"
022-267	Orange	6-5/8"	18"	4"
022-268	Blue	6-5/8"	11-5/8"	4"
022-269	Red	6-5/8"	11-5/8"	4"
022-270	Yellow	6-5/8"	11-5/8"	4"
022-271	Black	6-5/8"	11-5/8"	4"

022-253, 254, 255, 256, 259

Pac No. 006-491-30 pcs.

CLEAR PLASTIC BINS

Stock #.	Description	W	D	W
022-259	9 Compartment Tilt-Bin	23-5/8"	2-1/2"	3-5/16"
022-256	6 Compartment Tilt-Bin	23-5/8"	3-5/8"	4-1/2"
022-255	5 Compartment Tilt-Bin	23-5/8"	5-1/4"	6-1/2"
022-254	4 Compartment Tilt-Bin	23-5/8"	6-5/8"	8-1/8"
022-253	3 Compartment Tilt-Bin	23-5/8"	7-3/4"	9-1/2"

COLOUR-CODED
POPULAR
ITEMS

MERCHANDISERS

COMPACT
SPACING
ONE PRICE
PACKS

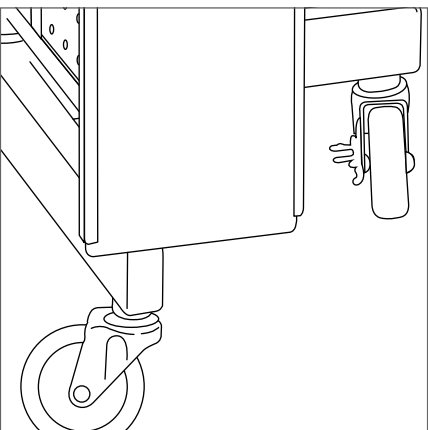
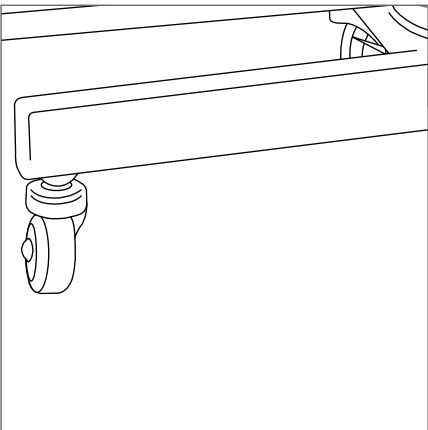
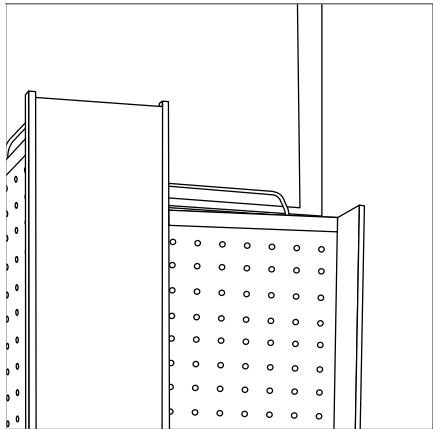
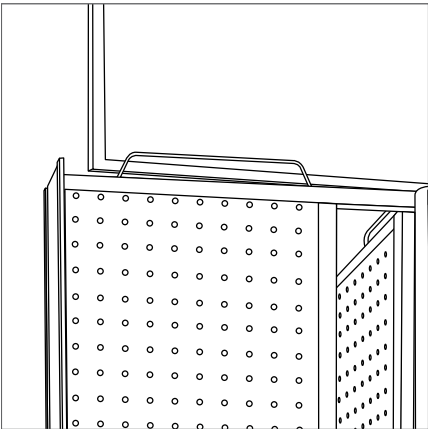

CODIFICATION
EN COULEUR
ITEMS
POPULAIRES
ESPACE RESTREINT
PRIX AU PAQUET

CARROUSEL DE FIXATION

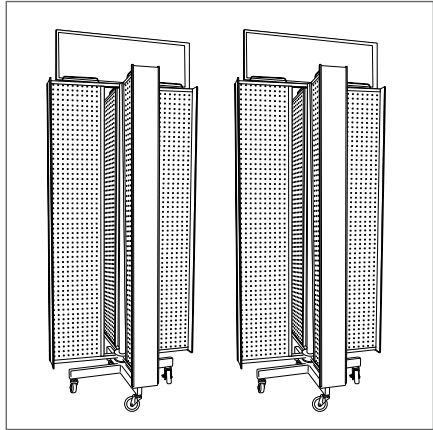

022-158

COLLISION REPAIR MERCHANDISER CONTENT

CL Part No.	Part No.	Pcs/Clam	Clamshells per Merchandiser	Page No.	CL Part No.	Part No.	Pcs/Clam	Clamshells per Merchandiser	Page No.
910-0005	245-903	4	2	21	910-0370	247-201	3	3*	50
910-0009	245-600	5	2	7	910-0375	247-058	3	3*	42
910-0015	245-617	3	5*	19	910-0380	247-002	5	3*	42, 46
910-0020	245-621	4	5*	16	910-0400	247-080	5	2	30
910-0025	245-630	2	5*	16	910-0405	247-065	3	2	28
910-0030	245-400	5	3*	17	910-0410	247-110	3	2	28
910-0035	245-326	5	2	17	910-0415	247-050	3	2	26, 30
910-0040	245-505	4	3*	19	910-0420	247-100	3	2	26, 31, 40
910-0043	245-405	3	5*	17	910-0425	247-101	2	2	26, 40
910-0046	245-322	4	2	17	910-0430	247-085	4	3*	30
910-0050	245-407	5	5*	17	910-0435	247-055	4	2	28
910-0053	245-408	4	2	18	910-0440	247-062	3	2	28
910-0057	245-323	3	2	17	910-0445	247-097	4	3*	31
910-0060	245-315	4	3*	17	910-0450	247-061	5	2	30
910-0065	245-510	3	2	19	910-0455	247-068	3	3*	30
910-0070	245-420	4	5*	18	910-0460	247-095	2	2	31
910-0075	245-526	2	5*	19	910-0465	247-082	3	2	30
910-0080	245-527	2	5*	19	910-0470	247-012	6	2	30
910-0085	245-441	3	3*	18	910-0475	247-872	2	3*	35
910-0090	245-440	2	5*	18	910-0480	247-103	5	2	31
910-0100	245-450	2	2	18	910-0485	247-104	3	2	26
910-0120	244-970	3	3*	14	910-0490	247-604	1	5*	36
910-0125	244-956	4	3*	14	910-0500	247-249	4	2	52
910-0130	244-955	4	3*	13	910-0505	247-248	3	2	52
910-0135	244-987	4	3*	14	910-0510	247-238	3	2	43
910-0140	244-997	3	5*	14	910-0515	247-078	3	2	60
910-0145	244-998	2	5*	14	910-0520	247-252	6	2	47
910-0150	244-988	3	5*	14	910-0550	247-466	4	2	45, 49, 55
910-0160	244-310	4	3*	13	910-0555	247-447	2	3*	29, 54
910-0165	244-985	6	3*	14	910-0560	247-404	4	3*	53
910-0170	244-957	2	5*	14	910-0565	247-405	3	2	53
910-0175	244-958	3	5*	14	910-0570	247-462	3	3*	48, 55
910-0180	244-959	4	3*	14	910-0575	247-878	2	2	58
910-0200	247-165	4	2	29	910-0580	247-885	2	3*	58
910-0205	247-236	3	2	43	910-0585	247-413	2	3*	44, 47, 53
910-0210	247-155	8	2	31	910-0590	247-473	3	2	49, 55
910-0215	247-215	5	2	42, 43, 46, 51	910-0595	247-869	3	3*	46, 57
910-0220	247-160	3	2	27	910-0600	247-873	1	2	57
910-0225	247-211	6	3*	42, 46, 51, 71	910-0605	247-417	2	2	44, 53, 58
910-0230	247-025	3	2	26, 28, 40,	910-0610	247-423	4	2	53
910-0235	247-026	5	2	26, 30	910-0611	247-452	3	3*	54
910-0240	247-020	4	2	26, 30	910-0615	247-511	2	2	45, 56, 58
910-0245	247-235	5	2	43, 47, 52	910-0620	247-510	2	2	50, 56
910-0250	247-210	4	2	32	910-0625	247-874	2	3*	46, 57
910-0255	247-010	5	2	30	910-0630	247-890	1	3*	46, 58
910-0260	247-216	3	3*	51	910-0635	247-467	3	3*	45, 49
910-0265	247-024	4	3*	46	910-0636	247-429	2	- †	48
910-0270	247-056	3	3*	50	910-0645	247-400	2	2	44
910-0275	247-038	4	3*	28	910-0650	247-456	2	3*	54
910-0280	247-232	3	3*	47	910-0651	247-458	2	3*	49, 55
910-0285	247-243	2	3*	52	910-0655	247-445	2	3*	54
910-0290	247-077	4	2	34	910-0675	247-493	2	2	55, 66, 70
910-0300	247-233	4	2	43, 47, 51	910-0680	247-877	2	2	57, 63, 66
910-0305	247-212	5	2	51	910-0681	247-446	3	- †	48, 54
910-0310	247-222	4	3*	46, 51	910-0682	247-396	2	- †	44, 48
910-0315	247-448	5	3*	48, 54	910-0683	247-397	1	- †	52
910-0320	247-242	3	3*	43, 52	910-0685	247-492	2	2	62
910-0325	247-884	2	2	29	910-0690	247-406	3	3*	44, 47, 53
910-0330	245-218	3	3*	34, 38	910-0691	247-468	2	2	49, 55
910-0335	245-219	3	3*	34, 38	910-0695	247-490	2	2	62, 66, 68
910-0340	247-057	2	2	42, 50	910-0700	247-409	2	3*	44, 53
910-0345	247-220	1	3*	51, 64	910-0705	247-494	2	3*	49, 64, 66, 68
910-0350	247-214	4	2	27, 29	910-0710	247-424	3	3*	54, 67
910-0355	247-221	2	3*	43, 47, 51	910-0715	247-495	1	2	62
910-0356	247-229	1	3*	43	910-0720	247-496	2	3*	62
910-0360	247-200	10	3*	50	910-0725	247-497	2	3*	62
910-0365	247-202	5	3*	50	910-0730	247-499	2	3*	62

* Includes 1 free pack

† Not presently included in 022-158 Merchandiser.

RÉPARATION DE COLLISION CARROUSEL DE FIXATION

No. 022-158

CL Part No.	Part No.	Pcs/Clam	Clamshells per Merchandiser	Page No.	CL Part No.	Part No.	Pcs/Clam	Clamshells per Merchandiser	Page No.
910-0735	247-883	2	3*	68	910-1190	230-616	4	3*	21
910-0740	247-488	2	2	62	910-1200	245-618	12	3*	7
910-0745	247-481	2	3*	65	910-1210	229-864	8	3*	5
910-0750	247-868	1	3*	65	910-1220	229-401	12	3*	4
910-0755	247-487	1	2	61	910-1225	229-403	10	3*	4
910-0760	247-484	1	3*	35, 61	910-1226	230-403	10	3*	7
910-0765	247-457	2	3*	55	910-1230	229-405	10	2	4
910-0785	247-475	2	2	45	910-1235	229-414	6	3*	4
910-0790	247-465	4	2	49	910-1237	229-416	5	3*	4
910-0795	247-460	2	2	49	910-1260	229-851	8	3*	5
910-0800	247-407	4	2	44, 53	910-1262	229-855	8	3*	5
910-0805	247-401	2	2	52	910-1263	229-856	6	3*	5
910-0807	247-428	2	- †	54	910-1270	230-623	3	3*	20
910-0810	247-411	3	2	53	910-1275	230-619	3	3*	20
910-0815	247-408	3	2	53	910-1280	229-575	2	3*	4
910-0820	247-527	4	3*	68	910-1285	245-310	6	2	17
910-0825	247-891	1	3*	63	910-1290	230-502	8	2	7
910-0830	247-102	3	2	31	910-1291	230-504	5	3*	7
910-0835	247-879	2	3*	65	910-1295	230-620	4	3*	7
910-0840	247-486	2	3*	61	910-1296	230-621	5	3*	7
910-0845	247-482	2	2	61	910-1297	230-622	4	3*	7
910-0850	247-483	2	3*	61, 67	910-1300	314-314	10	5*	24
910-0855	247-559	1	2	63	910-1302	314-316	10	5*	24
910-0860	247-474	1	3*	61, 67	910-1305	314-322	10	5*	24
910-0880	247-067	3	2	60	910-1306	314-326	6	5*	24
910-0885	247-151	6	2	38	910-1320	247-145	20	2	83
910-0889	247-075	10	3*	39	910-1325	246-411	4	2	23
910-0890	247-074	2	2	39	910-1330	246-418	6	3*	23
910-0891	247-069	4	3*	27, 31	910-1335	247-802	2	2	66
910-0895	247-275	3	3*	61	910-1340	247-860	3	3*	57, 71
910-0900	247-156	3	3*	69	910-1345	246-425	4	2	23
910-0905	247-157	3	3*	42,46,60,64,67	910-1350	246-413	6	2	23
910-0910	247-158	3	3*	69	910-1360	245-146	2	2	15
910-0915	247-159	3	3*	60	910-1370	245-150	2	2	15
910-0920	247-162	3	3*	61	910-1375	245-167	1	2	15
910-0925	247-870	2	3*	71	910-1380	245-172	1	2	15
910-0930	247-871	2	3*	71	910-1381	245-173	1	2	15
910-0935	247-149	4	2	27, 29	910-1385	245-183	1	2	15
910-0940	247-426	3	3*	48	910-1390	245-220	2	2	16
910-0945	247-161	1	3*	61	910-1405	240-614	3	3*	9
910-0950	247-899	2	3*	83	910-1406	240-615	3	3*	9
910-0955	247-900	4	3*	83	910-1407	240-616	3	5*	9
910-0960	247-298	1	3*	52	910-1408	240-617	2	3*	10
910-0965	247-297	2	3*	52	910-1409	240-619	2	3*	10
910-1005	229-120	15	2	3	910-1410	240-618	2	3*	10
910-1010	229-122	12	3*	3	910-1420	241-606	3	2	10
910-1020	229-142	12	2	3	910-1421	241-607	2	2	10
910-1030	229-320	15	2	3	910-1425	241-612	3	3*	11
910-1035	229-022	15	2	3	910-1427	241-609	3	3*	11
910-1040	229-024	15	2	3	910-1430	241-608	2	3*	11
910-1045	229-026	12	2	3	910-1435	241-610	2	3*	11
910-1050	229-044	12	2	3	910-1450	240-335	10	2	9
910-1070	229-224	10	2	5	910-1455	240-350	10	2	9
910-1080	213-137	12	2	3	910-1460	240-127	6	3*	8
910-1090	213-191	12	2	3	910-1465	240-101	7	2	8
910-1100	245-915	4	3*	21	910-1480	240-226	6	2	8
910-1105	213-278	6	3*	3	910-1481	240-228	6	2	8
910-1110	230-260	20	2	7	910-1482	240-230	4	2	8
910-1111	229-421	10	3*	4	910-1483	240-717	5	2	10
910-1113	229-423	10	3*	4	910-1490	240-250	6	2	8
910-1120	230-602	10	3*	7	910-1491	240-242	6	2	8
910-1140	232-071	15	2	7	910-1495	240-267	3	3*	9
910-1142	232-073	15	3*	7	910-1500	240-243	5	3*	8
910-1147	232-080	12	2	7	910-1505	240-263	6	2	9
910-1155	230-501	8	2	4	910-1515	240-706	5	2	10
910-1165	229-811	7	3*	5	910-1520	240-709	6	2	10
910-1167	229-815	6	3*	5	910-1525	240-710	3	3*	10
910-1170	229-837	5	2	5	910-1530	240-714	3	2	10
910-1180	229-862	6	2	5	910-1531	240-269	3	2	9
910-1185	245-914	8	3*	21	910-1555	240-613	3	3*	11

* Includes 1 free pack

† Not presently included in 022-158 Merchandiser.

CL Part No.	Part No.	Pcs/ Clam	Clamshells per Merchandiser	Page No.
910-1575	240-432	8	2	9
910-1600	250-549	3	2	74
910-1601	250-550	2	2	75
910-1602	250-551	2	3*	75
910-1603	250-552	3	3*	75
910-1605	242-206	12	2	11
910-1606	242-208	10	2	11
910-1607	242-210	12	3*	11
910-1608	242-214	10	2	12
910-1610	250-553	2	2	75
910-1615	250-545	2	3*	74
910-1616	250-546	2	3*	74
910-1620	250-559	1	2	74
910-1625	250-560	1	2	75
910-1630	250-561	1	5*	74
910-1635	250-565	1	3*	74
910-1660	239-960	1	2	8
910-1665	239-991	2	2	8
910-1670	246-122	2	3*	20
910-1675	246-124	2	2	20
910-1676	246-112	2	3*	20
910-1680	246-212	2	3*	22
910-1700	162-394	12	2	3
910-1703	162-395	8	3*	3
910-1706	162-397	9	2	3
910-1707	162-399	6	2	3
910-1710	250-371	7	2	24
910-1711	250-372	6	2	24
910-1715	250-082	5	2	24
910-1720	250-083	4	2	24
910-1725	250-363	4	2	24
910-1728	184-010	20	2	8
910-1740	242-308	12	2	12
910-1742	242-314	12	2	12
910-1743	242-316	12	2	12
910-1744	242-318	12	2	12
910-1745	242-320	12	3*	12
910-1746	242-322	10	3*	12
910-1755	243-305	10	3*	13
910-1756	243-306	10	2	13
910-1757	243-308	8	2	13
910-1759	243-312	8	3*	13
910-1800	246-616	2	3*	78
910-1805	246-612	2	3*	78
910-1810	246-600	4	2	78
910-1815	246-614	2	2	78
910-1820	246-610	3	2	78
910-1825	246-605	2	2	78
910-1835	247-313	3	3*	80
910-1840	247-307	3	3*	79
910-1845	247-306	3	3*	79
910-1850	247-300	3	2	79
910-1855	247-314	2	3*	80
910-1860	247-301	3	2	79
910-1865	247-310	3	3*	79
910-1870	247-304	3	2	79
910-1875	247-312	3	3*	79
910-1880	239-438	3	3*	78
910-1885	247-311	2	2	79
910-1890	247-308	3	2	79
910-1900	247-817	10	2	56
910-1905	247-841	6	3*	63
910-1907	247-838	4	3*	64, 70
910-1908	247-850	2	3*	35, 39
910-1915	247-826	4	3*	57
910-1920	247-821	8	3*	42, 46
910-1925	247-815	6	3*	56
910-1930	247-847	12	3*	66, 68
910-1935	247-824	10	3*	57

CL Part No.	Part No.	Pcs/ Clam	Clamshells per Merchandiser	Page No.
910-1940	240-833	5	3*	60, 66, 67, 69
910-1950	247-843	5	3*	67, 68, 70
910-1955	247-855	12	3*	37, 39
910-1945	247-856	6	3*	35, 37, 38
910-1960	240-832	5	3*	69
910-1965	247-842	4	3*	63
910-2000	247-830	5	2	57
910-2005	247-819	5	2	57
910-2010	240-800	10	2	19
910-2015	247-816	6	2	56
910-2020	247-849	5	3*	42
910-2025	247-825	5	2	46
910-2030	247-810	7	2	50
910-2035	247-831	5	2	57
910-2050	247-730	5	2	50
910-2055	247-726	3	2	45
910-2065	247-812	3	2	42, 56
910-2070	240-841	6	2	19
910-2075	247-840	5	2	57
910-2080	240-842	4	3*	19
910-2085	245-906	4	2	20
910-2095	247-716	6	2	56

WALL CHARTS

CHARTES MURALES



No. 022-035 SCREW AND BOLT WALL CHART

No. 022-036 CLIP, RIVET & ANCHOR WALL CHART

NEW

papeo[®]

Collision Repair Merchandiser

No. 022-158

LIST OF CONTENT

Plastic Plug Buttons

'U' Nuts

- Nylon 'U' Nuts
- Single Thread 'U' Nuts
- Speed Nuts

Grommets

- Headlamp Bezels
- License Plate Nuts
- Grille Fasteners
- Headlamp Door Nut

Windshield Mouldings

- Hog Ring
- Glass Shop Fasteners

Bumper Bolts

Washers & Shims

- Machine Screw Nuts
- Fender Washers
- Body Shims

Multi-Thread 'U' Nuts

Plastic Retainers

- 'Push' Type
- Trim Fasteners
- Plastic Shield
- Screw In
- Weather Strip Fasteners
- Cable Straps

Body Bolts

- Body Bolts
- Metal Screws
- License Plate Bolts
- Metric Flange Nuts

Self-Threading Palnuts

Rivets

- Blind Rivets
- Regulator Rivets
- Plastic Rivets

Tubular Type Speed Clips

Hinge Pins & Bushings

Mounting Nuts

- 'Jack' Nuts
- Blind Well Nuts

Moulding Fasteners

Pushnuts Bolt Retainers

Metal Screws

- Trim Screws
- Metal Screws



***BONUS OFFER**

Includes 187 free packs with every merchandiser purchase

953
CLAMSHELLS

Please contact your local Sales Representative for more information

H. Paulin & Co., Limited

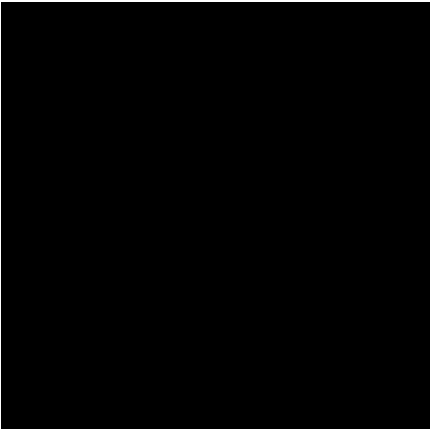

Distributed by/Distribué par:

