



CARBORUNDUM

**ABRASIVES FOR THE
INDUSTRIAL MARKET**

**EFFECTIVE
2015**



THIN WHEELS

COATED ABRASIVES

NON-WOVEN ABRASIVES

BONDED ABRASIVES

NON-ABRASIVE PRODUCTS

GENERAL INFORMATION





















products. pricing. experience.

the definition of
DIFFERENT™









Thin Wheels

	Depressed Center Wheels 4 – 9		Circular Saw Reinforced Cut-off Wheels 13		Chop Saw Reinforced Cut-off Wheels 17
	Precision Toolroom Cut-off Wheels 11		Right Angle Grinder Reinforced Cut-off Wheels 14 – 15		High-Speed Saw Reinforced Cut-off Wheels 18
	Small Diameter Reinforced Cut-off Wheels 12		Stationary Saw Reinforced Cut-off Wheels 16		Foundry Reinforced Cut-off Wheels 19

Coated Abrasives

	Fiber Discs 20 – 22		Stick-On Cloth Discs 47 – 48		Cloth Sheets 74 – 75
	E-ZView Flex-Loc Fiber Discs 23		Quick-Change Cloth Discs 49 – 56		Sandscreen Sheets 75
	Flap Discs 24 – 28		Cloth Belts 57 – 64		Marine File Strips 76 – 79
	Stick-On Paper Discs 29 – 36		FastTrack Belts 65 – 66		Abrasive Sponges 80
	Grip-On Paper Discs 37 – 44		Cloth Rolls 67		Flap Wheels 81 – 87
	Clean-Air Plus Vacuum Grip-On Paper Discs 45		Paper Rolls 68 – 69		Specialties 88 – 104
	Glue-On Paper Discs 46		Paper Sheets 70 – 74		Coated Abrasive Basics 105 – 106

Non-Woven Abrasives

	Non-Woven Depressed Center Wheels 107 – 109		Non-Woven Surface Prep Discs 113 – 114		Non-Woven Flap Wheels 125 – 127
	Non-Woven Surface Strip Discs 110 – 111		Non-Woven Quick-Change Discs 115 – 122		Non-Woven Belts 128
	Non-Woven E-ZView Flex-Loc Surface Prep Discs 112		Non-Woven Hand Pads and Rolls 123 – 124		Non-Woven Abrasive Basics 129 – 130

Bonded Abrasives



Portable Snagging Wheels,
Cones and Plugs
131 – 135



Toolroom Wheels
137 – 147



Mounted Points
151 – 154



Foundry Floorstand
Snagging Wheels
136



Bench and
Pedestal Wheels
148 – 149



Sharpening and
Dressing Products
155 – 157



Tool Post Wheels
136



Surface Grinding Segments
150



Bonded
Abrasive Basics
158 – 159

Non-Abrasives



Wire Brushes
160 – 163

General Information and Cross Reference



Part Number-to-Page
Cross Reference
164 – 172



Safety
173 – 177





No Risk Test Policy and
Contact Information
178

CARBORUNDUM *PRODUCT TIERING AND COLOR CODING*
Carborundum uses product performance tiering, color-coded for easy product selection.

BEST	<i>Highest Productivity – Lowest Total Cost</i>
BETTER	<i>Excellent Blend Of Performance And Price</i>
GOOD	<i>Consistent Performance – Low Initial Price</i>
STANDARD	<i>Standard Quality “White” – Opening Price Point</i>

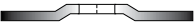

TYPE-TO-APPLICATION RECOMMENDATION GUIDE

WHEEL TYPE	APPLICATIONS
TYPE 27  .045", 1/16" and 3/32" Thick (Type 27/42) .125" Thick 1/8" Thick 1/4" Thick Z24 Long Life, 1/4" Thick	Cutting only, where fast cutting and low kerf loss are desired Ideal for pipe cutting Cutting and cleaning root pass welds Cutting-off, notching and light side grinding Grinding with low horsepower air and electric grinders or where low pressure is used Grinding with high horsepower machines (3 hp or higher) and heavy pressure; flame cut and other severe applications
TYPE 28  Saucers	Smooth, gouge-free grinding at shallow angles
TYPE 29  Gold Flexible	Polishing and blending applications

COMPETITIVE CROSS REFERENCE

CARBORUNDUM	3M	BRILLIANT	BULLARD	CAMEL	DEWALT	FLEXOVIT	METABO	PEARL	PFERD	SAIT	TYROLIT	WALTER
Carbo Premier Red	CUII, Green Corps	Brill-Max Z24R	TA24S, ZA24R	-	XP Ceramic, XP	Flexon ZA20Q, Flexon ZA30T	ZA24T	Z24T	ZA R SGP, Z-SG	Saitech Attacker, Pipeline, Ultimate Performance, Ztech	ZA24N-BFX, P, R	Allsteel XX, Xcavator, Double-X
Carbo Gold	High Performance	Brill-Tex A24UHPXL, A30T	A24T, A24R	A24T, A24R	HP	A24/30T, A30S, Metalhog	A24T, A24R	Redline Max A/WA24S, Premium Metal A24S, A24R	A-SG	A24T, A24R, A24 Turbo	A30S & Q-BFX	HP/Allsteel
Carbo Gold - Stainless Steel INOX	-	Brill-Tex A30P	A46Q	WA24S	HP INOX	Free Grind A30Q A360	WA24R, SRT24	A-PS INOX	XA24Q		A30-BF INOX	Stainless
Carbo Gold - Aluminum	-	Brill-Tex 30ALU	AL36N	A30N, Fast Cut	HP Aluminum	Specialist A24ALU	A36M	D.A. Series AL24M	A-SG ALU	A46N - Aluminum	A36N-BFX WA46-BF	Aluminum
Carbo White	General Purpose	Hornet Metal, Brill-Tex A24R	A24N, A24R Competitor	A24N, R&T Fast Cut	HP	Specialist A30R, A24N A30Q		Silver Line A24R & S	A-PS	A24N	A30R-BFX	-

STARTING RECOMMENDATIONS BY MATERIAL/APPLICATION

MATERIALS	HEAVY-DUTY GRINDING BEST PERFORMANCE	GENERAL-DUTY GRINDING	BLENDING AND FINISHING	CUTTING	SURFACE PREPARATION
Angle / Channel Iron Bar Stock / I-Beams Carbon / High Tensile Steel Metal Studs / Tubing	Premier Red Type 27	Gold Stainless Type 27 Gold Type 27	Gold Flexible Type 27, 29	Gold Type 27	Fibratex Surface Strip Fibratex Surface Blend
Cast Iron / Pipe	Premier Red Type 27	Gold Stainless Type 27 Gold Type 27	Gold Flexible Type 27, 29	Gold Type 27	Fibratex Surface Strip Fibratex Surface Blend
Aluminum / Brass / Bronze	Premier Red Type 27	Gold Stainless Type 27 Gold ALU Type 27	Gold Flexible Type 27, 29	Gold ALU Type 27	Fibratex Surface Strip Fibratex Surface Blend
Fiberglass / Plastic	-	Gold Flexible Type 27	Gold Flexible Type 27, 29	Gold Type 27	Fibratex Surface Strip Fibratex Surface Blend
Paint / Rust	-	Gold Type 27	-	-	-

techtip

Unique, patented mini-mount hub used on 4-1/2" and 5" depressed center wheels provides up to 30% more wheel life because the hub covers just a small surface area, providing maximum grinding area exposure and usage.

For best results, hold your right angle grinder at a:

- 30° angle with 1/4" and 1/8" thick Type 27 wheels
- 90° angle with .045", 1/16", 3/32", .125" and 1/8" thick Type 27 wheels
- 15° angle with saucers (Type 28) and Gold Flexible (Type 29) wheels



It is the user's responsibility to refer to and comply with ANSI B7.1



90°



30°



15°

PREMIER RED DEPRESSED CENTER WHEELS

Better Tier / Zirconia Alumina



Z24 Outstanding results grinding stainless steel, high alloy steel, and all ferrous metals.

Z24 Long Life Extended life when grinding stainless steel, high alloy steel and all ferrous metals. Best used on high frequency grinders or air grinders with appropriate air supply.

FEATURES	BENEFITS
• High-performance zirconia alumina abrasive	• 60% faster stock removal and a minimum of 3X the life over aluminum oxide wheels
• High-performance resin bond	• Enhanced life; exceptional cut rate
• Exceptional balance	• No vibration or bouncing on workpiece
	• Less grinder maintenance
	• Less operator fatigue
• Unique glass cloth reinforcement design	• No fraying or spalling of abrasive grit
	• Smaller glass on the grinding surface to allow for immediate fast cutting
• Better performing wheel	• Highest productivity; lowest total grinding cost

FOR GRINDING

PART #	WHEEL SIZE	GRADING	MAX. RPM	WHEELS/ BOX
FOR METAL/STAINLESS STEEL				
TYPE 27 – FOR RIGHT ANGLE GRINDERS				
05539502864	3 x 1/4 x 3/8	Z24	18,000	20
05539502867	4 x 1/4 x 3/8	Z24	15,280	20
05539502868	4 x 1/4 x 5/8	Z24	15,280	20
05539502873	4-1/2 x 1/4 x 5/8-11	Z24	13,580	20
05539502872	4-1/2 x 1/4 x 7/8	Z24	13,580	20
05539502877	5 x 1/4 x 5/8-11	Z24	12,225	20
05539502876	5 x 1/4 x 7/8	Z24	12,225	20
66252844359	6 x 1/4 x 5/8-11	Z24	10,185	10
66252844358	6 x 1/4 x 7/8	Z24	10,185	20
05539502883	7 x 1/4 x 5/8-11	Z24	8,600	10
05539502884	7 x 1/4 x 5/8-11	Z24 Long Life	8,600	10
05539502881	7 x 1/4 x 7/8	Z24	8,600	20
05539502882	7 x 1/4 x 7/8	Z24 Long Life	8,600	20
05539502889	9 x 1/4 x 5/8-11	Z24	6,600	10
05539502890	9 x 1/4 x 5/8-11	Z24 Long Life	6,600	10
66252844378	9 x 1/4 x 7/8	Z24	6,600	20
TYPE 28 – FOR RIGHT ANGLE GRINDERS				
05539502892	7 x 1/4 x 5/8-11	Z24	8,600	10
66252844362	9 x 1/4 x 5/8-11	Z24	6,600	10

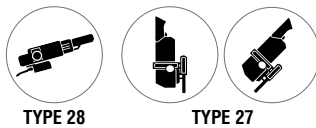

FOR LIGHT GRINDING AND CUTTING

PART #	WHEEL SIZE	GRADING	MAX. RPM	WHEELS/ BOX
FOR METAL/STAINLESS STEEL				
TYPE 27 – FOR RIGHT ANGLE GRINDERS				
05539507349	4 x 1/8 x 3/8	Z24	15,280	20
66252844354	4 x 1/8 x 5/8	Z24	15,280	20
05539504702	4-1/2 x 1/8 x 5/8-11	Z24	13,580	20
05539504701	4-1/2 x 1/8 x 7/8	Z24	13,580	20
66252844377	5 x 1/8 x 5/8-11	Z24	12,225	20
05539504703	5 x 1/8 x 7/8	Z24	12,225	20
66252844357	6 x 1/8 x 5/8-11	Z24	10,185	10
66252844356	6 x 1/8 x 7/8	Z24	10,185	20
05539504706	7 x 1/8 x 5/8-11	Z24	8,600	10
66252844360	7 x 1/8 x 7/8	Z24	8,600	20
05539504708	9 x 1/8 x 5/8-11	Z24	6,600	10
66252844361	9 x 1/8 x 7/8	Z24	6,600	20

FOR CUTTING

PART #	WHEEL SIZE	GRADING	MAX. RPM	WHEELS/ BOX
FOR METAL/STAINLESS STEEL				
TYPE 27 – FOR RIGHT ANGLE GRINDERS				
05539502863	3 x .125 x 3/8	Z24	18,000	20
05539502865	4 x .125 x 3/8	Z24	15,280	20
05539502871	4-1/2 x .125 x 5/8-11	Z24	13,580	20
05539502870	4-1/2 x .125 x 7/8	Z24	13,580	20
05539502874	5 x .125 x 7/8	Z24	12,225	20
66252842466	5 x .125 x 5/8-11	Z24	12,225	20
05539502879	7 x .125 x 5/8-11	Z24	8,600	10
05539502878	7 x .125 x 7/8	Z24	8,600	20

techtip

- 1 For maximum performance, run the grinder at the "Maximum Operating Speed", which is marked on the wheel.
- 2 Carbo Gold wheels for Metal/Steel also grind stainless steel very well. It is important to remember though that contamination, such as iron, can happen if an operator grinds with the same wheel on carbon steel then moves to a workpiece of stainless steel to grind.
- 3 Carbo Gold wheels formulated for stainless can be used as an extra fast cutting wheel for any grinding application.
- 4 Remember to keep your wheels used to grind carbon steel away from stainless steel if you need to avoid contamination of the stainless steel.



It is the user's responsibility to refer to and comply with ANSI B7.1

PREMIER REDCUT DEPRESSED CENTER WHEELS

Better Tier / Zirconia Alumina



Engineered for cutting pipe, plate and all types of carbon and stainless steel and various hard alloys.



FEATURES	BENEFITS
• Zirconia alumina abrasive	• Burn-free cutting, fast cut rate
• Advanced resin bond	• Long life
• Extra thin	• Quick cutting action
	• Minimal kerf loss
• Specially reinforced	• Added safety, strength and straight cuts

FOR CUTTING

PART #	WHEEL SIZE	GRADING	MAX. RPM	WHEELS/ BOX
FOR METAL/STAINLESS STEEL				
TYPE 27/42 – FOR RIGHT ANGLE GRINDERS				
66252844369	4-1/2 x .045 x 7/8	ZA60	13,580	25
66252844370	5 x .045 x 7/8	ZA60	12,225	25
66252844371	6 x .045 x 7/8	ZA60	10,185	25



TYPE 27/42

CARBO GOLD DEPRESSED CENTER WHEELS

Good Tier / Aluminum Oxide



A24 Aluminum Oxide Abrasive – For Steel/Metal The choice for grinding all types of ferrous metals and various alloy steels.

ZA30 Aluminum Oxide Abrasive – For Stainless Steel Ideal for grinding all types of stainless steel and various hard alloys. Clean bond is formulated to meet nuclear industry standards; no iron, sulphur or chlorine in bond specification to contaminant workpieces.



A46 Aluminum Oxide Abrasive – For Aluminum Engineered for grinding aluminum weld beads and fabricated parts. Special filler in the bond mixture to enhance metal removal without loading.

FEATURES	BENEFITS
• Premium aluminum oxide abrasive	• Fast stock removal due to extra grain sharpness
• Advanced resin bond	• Free cutting without a reduction in wheel life
• Exceptional balance	• No vibration
	• No burning of workpiece
	• Less grinder maintenance
	• Less operator fatigue
• Unique glass cloth reinforcement design	• No fraying or spalling of abrasive grit

FOR GRINDING

PART #	WHEEL SIZE	GRADING	MAX. RPM	WHEELS/ BOX
FOR STEEL/METAL/STAINLESS STEEL				
TYPE 27 – FOR RIGHT ANGLE GRINDERS				
66252844381	3 x 1/4 x 3/8	A24	18,000	20
05539502836	4 x 1/4 x 3/8	A24	15,280	20
05539502837	4 x 1/4 x 5/8	A24	15,280	20
05539502843	4-1/2 x 1/4 x 5/8-11	A24	13,580	20
05539502842	4-1/2 x 1/4 x 7/8	A24	13,580	20
05539502847	5 x 1/4 x 5/8-11	A24	12,225	20
05539502846	5 x 1/4 x 7/8	A24	12,225	20
66252844374	6 x 1/4 x 5/8-11	A24	10,185	10
05539502849	6 x 1/4 x 7/8	A24	10,185	20
05539502854	7 x 1/4 x 5/8-11	A24	8,600	10
05539502853	7 x 1/4 x 7/8	A24	8,600	20
05539502858	9 x 1/4 x 5/8-11	A24	6,600	10
05539502857	9 x 1/4 x 7/8	A24	6,600	20

FOR GRINDING

PART #	WHEEL SIZE	GRADING	MAX. RPM	WHEELS/ BOX
FOR STEEL/METAL/STAINLESS STEEL				
TYPE 28 – FOR RIGHT ANGLE GRINDERS				
05539502860	7 x 1/4 x 5/8-11	A24	8,600	10
05539502859	7 x 1/4 x 7/8	A24	8,600	20
05539502862	9 x 1/4 x 5/8-11	A24	6,600	10
05539502861	9 x 1/4 x 7/8	A24	6,600	20

Continued on next page.



TYPE 28



TYPE 27



FOR GRINDING

PART #	WHEEL SIZE	GRADING	MAX. RPM	WHEELS/ BOX
FOR STAINLESS STEEL				
TYPE 27 – FOR RIGHT ANGLE GRINDERS				
05539570192	4-1/2 x 1/4 x 5/8-11	ZA30	13,580	20 ●
05539570191	4-1/2 x 1/4 x 7/8	ZA30	13,580	20 ●
66252842468	5 x 1/4 x 5/8-11	ZA30	12,225	20 ●
05539570193	5 x 1/4 x 7/8	ZA30	12,225	20 ●
66252830562	6 x 1/4 x 7/8	ZA30	10,185	20 ●
05539570195	7 x 1/4 x 5/8-11	ZA30	8,600	10 ●
05539570194	7 x 1/4 x 7/8	ZA30	8,600	20 ●
05539570197	9 x 1/4 x 5/8-11	ZA30	6,600	10 ●
05539570196	9 x 1/4 x 7/8	ZA30	6,600	20 ●

FOR ALUMINUM

PART #	WHEEL SIZE	GRADING	MAX. RPM	WHEELS/ BOX
TYPE 27 – FOR RIGHT ANGLE GRINDERS				
05539508158	4-1/2 x 1/4 x 5/8-11	A46	13,580	20
05539503588	4-1/2 x 1/4 x 7/8	A46	13,580	20
66252844363	5 x 1/4 x 5/8-11	A46	12,225	20
05539503589	5 x 1/4 x 7/8	A46	12,225	20
66252844379	6 x 1/4 x 7/8	A46	10,185	20
05539503594	7 x 1/4 x 5/8-11	A46	8,600	10
66252844364	7 x 1/4 x 7/8	A46	8,600	20

FOR CUTTING

PART #	WHEEL SIZE	GRADING	MAX. RPM	WHEELS/ BOX
FOR STEEL/METAL/STAINLESS STEEL				
TYPE 27 – FOR RIGHT ANGLE GRINDERS				
05539502833	4 x .125 x 3/8	A24	15,280	20
05539502834	4 x .125 x 5/8	A24	15,280	20
05539502839	4-1/2 x .125 x 5/8-11	A24	13,580	20
05539502838	4-1/2 x .125 x 7/8	A24	13,580	20
66252844349	5 x .125 x 5/8-11	A24	12,225	20
05539502844	5 x .125 x 7/8	A24	12,225	20
05539502848	6 x .125 x 7/8	A24	10,185	20
05539502851	7 x .125 x 5/8-11	A24	8,600	10
05539502850	7 x .125 x 7/8	A24	8,600	20
05539502856	9 x .125 x 5/8-11	A24	6,600	10
05539502855	9 x .125 x 7/8	A24	6,600	20

FOR LIGHT GRINDING AND CUTTING

PART #	WHEEL SIZE	GRADING	MAX. RPM	WHEELS/ BOX
FOR STEEL/METAL/STAINLESS STEEL				
TYPE 27 – FOR RIGHT ANGLE GRINDERS				
66252844373	3 x 1/8 x 3/8	A24	18,000	20
05539504709	4 x 1/8 x 5/8	A24	15,280	20
05539504711	4-1/2 x 1/8 x 5/8-11	A24	13,580	20
05539504710	4-1/2 x 1/8 x 7/8	A24	13,580	20
66252844350	5 x 1/8 x 5/8-11	A24	12,225	20
05539504712	5 x 1/8 x 7/8	A24	12,225	20
66252844353	6 x 1/8 x 5/8-11	A24	10,185	10
05539504714	6 x 1/8 x 7/8	A24	10,185	20
05539504716	7 x 1/8 x 5/8-11	A24	8,600	10
66252844376	7 x 1/8 x 7/8	A24	8,600	20
05539504718	9 x 1/8 x 5/8-11	A24	6,600	10
05539504717	9 x 1/8 x 7/8	A24	6,600	20
FOR STAINLESS STEEL				
TYPE 27 – FOR RIGHT ANGLE GRINDERS				
66252832395	4-1/2 x 1/8 x 5/8-11	ZA30	13,580	20 ●
66252832507	4-1/2 x 1/8 x 7/8	ZA30	13,580	20 ●
66252842467	5 x 1/8 x 5/8-11	ZA30	12,225	20 ●
66252832508	5 x 1/8 x 7/8	ZA30	12,225	20 ●
66252830561	6 x 1/8 x 7/8	ZA30	10,185	20 ●
66252832396	7 x 1/8 x 5/8-11	ZA30	8,600	10 ●
66252832509	7 x 1/8 x 7/8	ZA30	8,600	20 ●
66252830879	9 x 1/8 x 5/8-11	ZA30	6,600	10 ●

● = Free of FE + S + CL



TYPE 28



TYPE 27



techtip

- 1 Carbo Gold wheels for Metal/Steel also grind stainless steel very well. It is important to remember though that contamination, such as iron, can happen if an operator grinds with the same wheel on carbon steel then moves to a workpiece of stainless steel to grind.
- 2 Carbo Gold wheels formulated for stainless can be used as an extra fast cutting wheel for any grinding application.
- 3 Remember to keep your wheels used to grind carbon steel away from stainless steel if you need to avoid contamination of the stainless steel.

CARBO GOLD[™] DEPRESSED CENTER WHEELS

Good Tier / Aluminum Oxide

CARBO[™]
GOLDCUT[™]



Engineered for cutting pipe, plate and all types of carbon and stainless steel and various hard alloys.

FEATURES	BENEFITS
• Premium aluminum oxide abrasive	• Burn-free cutting
• Advanced resin bond	• Long life
• Extra thin	• Quick cutting action
	• Minimal kerf loss
• Specially reinforced	• Added safety, strength and straight cuts
• Hubbed wheels	• Quick, tool-free changes increase productivity

FOR CUTTING

PART #	WHEEL SIZE	GRADING	MAX. RPM	WHEELS/ BOX
FOR STEEL/METAL/STAINLESS STEEL				
TYPE 27/42 – FOR RIGHT ANGLE GRINDERS				
66252844347	4-1/2 x 3/32 x 5/8-11	A30	13,580	20
05539563817	4-1/2 x 3/32 x 7/8	A30	13,580	20
66252844348	5 x 3/32 x 5/8-11	A30	12,225	20
05539563819	5 x 3/32 x 7/8	A30	12,225	20
66252844352	6 x 3/32 x 5/8-11	A30	10,185	10
66252844351	6 x 3/32 x 7/8	A30	10,185	20
66252844375	7 x 3/32 x 5/8-11	A30	8,600	10
05539563821	7 x 3/32 x 7/8	A30	8,600	20



TYPE 27/42

FOR CUTTING

PART #	WHEEL SIZE	GRADING	MAX. RPM	WHEELS/ BOX
FOR STEEL/METAL				
TYPE 27/42 – FOR RIGHT ANGLE GRINDERS				
66252844537	4 x .045 x 5/8	A30	13,580	20
66252830584	4-1/2 x .045 x 5/8-11	A30	13,580	20
05539561551	4-1/2 x .045 x 7/8	A30	13,580	20
66252844367	5 x .045 x 5/8-11	A30	12,225	20
05539561553	5 x .045 x 7/8	A30	12,225	20
66252844368	6 x .045 x 5/8-11	A30	10,185	20
05539561554	6 x .045 x 7/8	A30	10,185	20
05539561555	7 x 1/16 x 7/8	A30	8,600	20
66252830585	9 x 1/16 x 5/8-11	A30	6,600	10

CARBO WHITE[™] DEPRESSED CENTER WHEELS

Standard Tier / Aluminum Oxide

CARBO[™]
WHITE[™]



Standard choice for steel/metal applications with low initial price.

FEATURES	BENEFITS
• Aluminum oxide abrasive	• Engineered for all steel/ferrous metals
• Low initial price point	• Best starting specification for end-user unable to measure performance

FOR CUTTING

PART #	WHEEL SIZE	GRADING	MAX. RPM	WHEELS/ BOX
FOR STEEL/METAL/STAINLESS STEEL				
TYPE 27/42 – FOR RIGHT ANGLE GRINDERS				
66252836280	4-1/2 x .045 x 7/8	A60	13,580	20
66252836281	5 x .045 x 7/8	A60	12,225	20
66252836282	6 x .045 x 7/8	A60	10,185	20

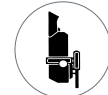

TYPE 27/42



TYPE 27

FOR GRINDING

PART #	WHEEL SIZE	GRADING	MAX. RPM	WHEELS/ BOX
FOR STEEL/METAL				
TYPE 27 – FOR RIGHT ANGLE GRINDERS				
05539561568	4-1/2 x 1/4 x 5/8-11	A24	13,580	20
05539561567	4-1/2 x 1/4 x 7/8	A24	13,580	20
05539561571	5 x 1/4 x 7/8	A24	12,225	20
05539561576	7 x 1/4 x 5/8-11	A24	8,600	10
05539561575	7 x 1/4 x 7/8	A24	8,600	20
05539561580	9 x 1/4 x 5/8-11	A24	6,600	10
05539561579	9 x 1/4 x 7/8	A24	6,600	20

FOR LIGHT GRINDING AND CUTTING

PART #	WHEEL SIZE	GRADING	MAX. RPM	WHEELS/ BOX
FOR STEEL/METAL				
TYPE 27 – FOR RIGHT ANGLE GRINDERS				
05539561566	4-1/2 x 1/8 x 5/8-11	A24	13,580	20
05539561565	4-1/2 x 1/8 x 7/8	A24	13,580	20
05539561569	5 x 1/8 x 7/8	A24	12,225	20
05539561574	7 x 1/8 x 5/8-11	A24	8,600	10
05539561573	7 x 1/8 x 7/8	A24	8,600	20
05539561578	9 x 1/8 x 5/8-11	A24	6,600	10
05539561577	9 x 1/8 x 7/8	A24	6,600	20

CARBO GOLD FLEXIBLE DEPRESSED CENTER WHEELS

Good Tier / Aluminum Oxide



Blending, finishing and polishing of stainless steel, aluminum, structural steel, carbon steel, cast iron welds and burrs.

FEATURES	BENEFITS
<ul style="list-style-type: none"> Aluminum oxide grain 	<ul style="list-style-type: none"> Cool cutting; leaves no burn marks Prevents loading
<ul style="list-style-type: none"> Flexible 	<ul style="list-style-type: none"> Excellent control of finish quality and removal rate in light stock removal applications
<ul style="list-style-type: none"> Type 29 conical has nubs on the face; (use at a 15° angle) Type 27 has concentric grooves 	<ul style="list-style-type: none"> Shallow grinding angle permits larger contact area with less gouging of workpiece Nubs/grooves allow more air to circulate in grinding zone, promoting cooler cutting (reducing heat and loading) and better swarf removal Ideal for getting into tight spaces, smoothing corners and curves, and polishing and blending welds on flat surfaces

FOR BLENDING AND POLISHING

PART #	WHEEL SIZE	GRADING	MAX. RPM	WHEELS/BOX
FOR STEEL/METAL/STAINLESS STEEL				
TYPE 27 – FOR RIGHT ANGLE GRINDERS				
05539567289	4-1/2 x 1/8 x 7/8	A60-Medium	13,580	20
05539567287	7 x 1/8 x 5/8-11	A60-Medium	8,600	10
FOR STEEL/METAL				
TYPE 29 – FOR RIGHT ANGLE GRINDERS				
66252833457	4-1/2 x 1/8 x 7/8	A36	13,580	20
66252833458	5 x 1/8 x 7/8	A36	12,225	20

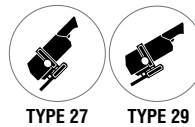

METAL ADAPTER KIT

Accessory



This adapter kit contains the items necessary to mount depressed center wheels with 7/8" center holes on to standard portable right angle or vertical shaft grinders. Adapter hubs are threaded for mounting on to standard 5/8"-11 NCRH spindles. This adapter kit may be used with wheel thicknesses of 1/8" or 1/4". All depressed center wheels must use the proper adapters to securely mount to the spindle.

PART #	DESCRIPTION	KITS/BOX
FOR DEPRESSED CENTER WHEELS		
07660789275	Adapter Kit	1

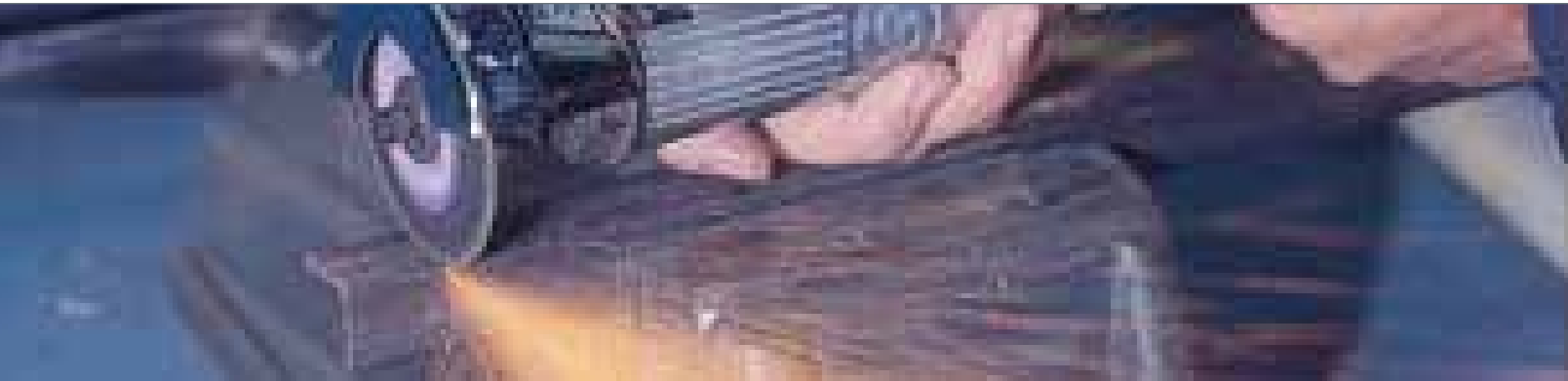

COMPETITIVE CROSS REFERENCE

CARBORUNDUM	3M	BRILLIANT	BULLARD	CAMEL	DEWALT	FLEXOVIT	METABO	PEARL	PFERD	SAIT	TYROLIT	WALTER
Carbo Premier Red	CUII	–	ZA60T	ZA Quickie Cut	XP	–	Super Slicer	Redline Max Slimcut	SGP-ZA-INOX	Saittech .045, Sait Z-Tech .045, Saittech Steel Worker	Premium	A30-Zip, A30-Chopcut II
Carbo Gold	HP	Brill-Blade Extra FC	A60T	Super Quickie Cut	HP	Razorblade A24T, A30V, A30RB, A24SB	Slicer Plus, A30R, A30S	Slimcut	SG	Sait A60S, Ultimate Cut, Sait MX, EZ Chop, Iron Worker	Standard	A30-Zip, A60-Zip, A30-HC Chopcut
Carbo Gold - Stainless Steel INOX	–	–	–	–	HP SS	WA60R Quickie Cut	RazorBlade A60SST	–	SG-INOX	XA46R	–	A60-ZIP SS
Carbo Gold - Aluminum	–	AL46N	–	A46 Quickie Cut	HP Aluminum	Razorblade A30Q	–	–	SG-ALU	A46N	–	A60-ZIP ALU
Carbo White	–	Hornet Stinger	–	Quickie Cut	HP	Razorblade A30Q	Slicer	Slimcut Pro-V, Silverline	–	–	Basic	–

STARTING RECOMMENDATIONS BY MATERIAL

MATERIAL	IN-LINE GRINDERS	RIGHT ANGLE GRINDERS	PORTABLE GAS / ELECTRIC SAWS	STATIONARY SAWS	CHOP SAWS
Angle / Channel Iron / Bar / Sheet Stock	Premier Red, Gold	Premier RedCut	Gold Metal	Premier Red, Gold Long Life	Premier Red Long Life, Gold Long Life
Metal Studs / Tubing	–	GoldCut	Gold Metal	Gold Long Life	Gold Long Life
Cast Iron / Pipe	Gold	GoldCut	Gold Metal	Gold Fast Cut	Gold Fast Cut
Stainless / Alloys	Premier Red	Premier RedCut	Gold Metal	Premier Red	Premier Red Fast Cut
Aluminum / Brass / Bronze	Gold	GoldCut	Gold Metal	Gold Fast Cut	Gold Fast Cut
Concrete / Brick / Block / Asphalt / Green Concrete	–	–	Gold Concrete	–	–
Ductile	–	–	Gold Ductile	–	–
Paint / Rust / Fiberglass / Plastic	Gold	GoldCut	–	Gold Fast Cut	Gold Fast Cut

TROUBLESHOOTING GUIDE

PROBLEM	POSSIBLE CAUSES	CORRECTION
Non-square cuts	Work not clamped properly Misaligned spindle bearings Poor coolant distribution Wheel is too hard	Check clamp and clean to remove swarf Check for bearing truth and alignment Ensure equal volume of coolant to each wheel side Use softer acting wheel - softer grade/finer grit
Workpiece burn	Insufficient feed rate Poor coolant flow Wheel is too coarse Wheel is too hard Wheel is running out Wheel speed is too slow	Work machine to maximum power available Increase volume and direct at cutting point Use finer wheel or more machine power Use softer grade wheel Check spindle and flanges Ensure tight flanges and maximum speed marked on wheel being used
Poor finish	Too much burr Wheel too coarse	Use finer grit or softer wheel Use finer grit

REINFORCED PRECISION TOOLROOM CUT-OFF WHEELS

Good Tier / Aluminum Oxide

CARBO™



Used primarily for cutting off high speed steel drill bits and end mills, as well as slotting dies.

FEATURES	BENEFITS
<ul style="list-style-type: none"> Aluminum oxide abrasive Resin bond 	<ul style="list-style-type: none"> Fast cut rate and long life Free cutting action Burn-free cutting
<ul style="list-style-type: none"> High strength, reinforced construction BFTK - side reinforced, rough sides Decimal thickness 	<ul style="list-style-type: none"> Resists breakage and provides straight cuts Maximum cut rate Very narrow cuts; minimum kerf loss

PART #	WHEEL SIZE	GRADING	MAX. RPM	WHEELS/ BOX
FOR HIGH-SPEED STEEL AND TOOL STEELS				
05539518986	6 x .060 x 1-1/4	A60-OBFTK	10,190	10
05539509197	7 x .035 x 5/8	A60-OBFTK	8,730	10
05539509196	7 x .035 x 1-1/4	BA60-OBFTK	8,730	10
05539509195	7 x .060 x 5/8	A60-OBFTK	8,730	10
05539509194	7 x .060 x 1-1/4	BA60-OBFTK	8,730	10
05539509192	8 x .060 x 1-1/4	A60-OBFTK	7,640	10



TYPE 01

NON-REINFORCED PRECISION TOOLROOM CUT-OFF WHEELS

Good Tier / Aluminum Oxide

CARBO™



For use on machines where the work is rigidly clamped and the wheel operates on a controlled cutting plane with no twisting or lateral stresses. Ideal for slotting dies or cutting off high-speed steel drills and end mills.

FEATURES	BENEFITS
<ul style="list-style-type: none"> Aluminum oxide abrasive Resin bond 	<ul style="list-style-type: none"> Fast cut rate and long life Free cutting action Burn-free cutting Long life

PART #	WHEEL SIZE	GRADING	MAX. RPM	WHEELS/ BOX
FOR HIGH-SPEED STEEL AND TOOL STEELS				
05539509188	6 x 1/16 x 1-1/4	A60-OB5SW	7,640	10
05539501923	7 x 1/32 x 1-1/4	A60-MB5SW	5,460	10
05539509187	7 x 1/32 x 1-1/4	A60-OB5SW	5,460	10
05539509186	7 x 1/32 x 1-1/4	A70-QB5SW	5,460	10
05539509185	7 x 1/16 x 1-1/4	A46-OB5SW	6,550	10
05539509184	7 x 1/16 x 1-1/4	A60-OB5SW	6,550	10
05539509183	8 x 1/16 x 1-1/4	A46-OB5SW	5,730	10
05539501926	8 x 1/16 x 1-1/4	A60-MB5SW	5,730	10
05539562839	10 x 1/16 x 5/8	A46-QB5RW	4,585	10
05539509181	10 x 1/16 x 5/8	A60-OB5SW	4,585	10



TYPE 01

techtip

- Reinforced cut-off wheels are designed to resist breakage caused by severe cross-bending and are required on any operation where the work is not securely clamped.
- Non-reinforced cut-off wheels are designed for use on “fixed-base” types of machines where the work is securely clamped, guarded, and where the wheel operates on a controlled cutting plane.

 It is the user's responsibility to refer to and comply with ANSI B7.1



PREMIER RED SMALL DIAMETER REINFORCED CUT-OFF WHEELS

Best Tier / Ceramic Alumina/Zirconia Alumina Blend



Ideal for cutting all types of stainless steel and steel alloys.

FEATURES	BENEFITS
<ul style="list-style-type: none"> An exclusive blend of high-performance ceramic alumina and zirconia alumina abrasives 	<ul style="list-style-type: none"> Up to 50% added wheel life Up to 5X the life versus aluminum oxide wheels on carbon steel, cast iron, stainless steel, and exotic metals
<ul style="list-style-type: none"> Advanced grain and bond technology 	<ul style="list-style-type: none"> Substantially longer wheel life Fastest cut rate
<ul style="list-style-type: none"> 1/32" and .035 thick – fastest initial cut rate 	<ul style="list-style-type: none"> Minimum kerf loss
<ul style="list-style-type: none"> 1/16" thick 	<ul style="list-style-type: none"> For demanding applications
<ul style="list-style-type: none"> 1/8" and 3/16" thick – exceptional control 	<ul style="list-style-type: none"> Longest lasting
<ul style="list-style-type: none"> Smaller blotters 	<ul style="list-style-type: none"> Faster, freer cutting

PART #	WHEEL SIZE	GRADING	MAX. RPM	WHEELS/ BOX
FOR STEEL/METAL/STAINLESS STEEL				
05539503861	3 x 1/32 x 3/8	MZ60-T	25,465	50
05539503863	3 x 1/16 x 3/8	MZ36-T	25,465	50
05539504270	3 x 3/16 x 3/8	MZ36-T	25,465	50
05539503507	4 x .035 x 3/8	MZ60-T	19,100	25
05539503508	4 x 1/16 x 3/8	MZ36-T	19,100	25
05539503509	4 x 1/8 x 3/8	MZ36-T	19,100	25

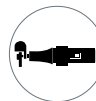

TYPE 01

CARBO GOLD SMALL DIAMETER REINFORCED CUT-OFF WHEELS

Good Tier / Aluminum Oxide



For cutting off ferrous metals, alloy steels and cast iron.

FEATURES	BENEFITS
<ul style="list-style-type: none"> Aluminum oxide abrasive Resin bond 	<ul style="list-style-type: none"> Fast cut rate Free cutting action Burn-free cutting Long life
<ul style="list-style-type: none"> High-strength, reinforced construction 	<ul style="list-style-type: none"> Resists breakage and provides straight cutting
<ul style="list-style-type: none"> A60 - light glass cloth reinforcement design 	<ul style="list-style-type: none"> Maximum cut rate Minimum kerf loss
<ul style="list-style-type: none"> A36 reinforced 	<ul style="list-style-type: none"> Versatile, durable free cutting

PART #	WHEEL SIZE	GRADING	MAX. RPM	WHEELS/ BOX
FOR STEEL/METAL				
05539509277	2 x .035 x 1/4	A60	30,560	25
05539509276	2 x .035 x 3/8	A60	30,560	25
05539509275	2 x 1/16 x 1/4	A36	30,560	25
66252844365	2 x 1/16 x 3/8	A36	30,560	25
05539509269	3 x .035 x 1/4	A60	25,465	25
05539509268	3 x .035 x 3/8	A60	25,465	25
05539509265	3 x 1/16 x 1/4	A36	25,465	25
05539509264	3 x 1/16 x 1/4	A60	25,465	25
05539509263	3 x 1/16 x 3/8	A36	25,465	25
05539509262	3 x 1/16 x 3/8	A60	25,465	25
05539509261	3 x 1/8 x 1/4	A36	25,465	25
05539509260	3 x 1/8 x 3/8	A36	25,465	25

PART #	WHEEL SIZE	GRADING	MAX. RPM	WHEELS/ BOX
FOR STEEL/METAL				
05539509258	4 x .035 x 1/4	A60	19,100	25
05539509257	4 x .035 x 3/8	A60	19,100	25
05539509255	4 x 1/16 x 1/4	A36	19,100	25
05539509254	4 x 1/16 x 3/8	A36	19,100	25
66252844366	4 x 1/8 x 1/4	A36	19,100	25
05539509252	4 x 1/8 x 3/8	A36	19,100	25



TYPE 01

REINFORCED CIRCULAR SAW CUT-OFF WHEELS

Good Tier / Aluminum Oxide

CARBO™



Used on hand-held portable circular saws to cut steel and all types of metals.

FEATURES	BENEFITS
<ul style="list-style-type: none">• Aluminum oxide abrasive• Resin bond	<ul style="list-style-type: none">• Fast cut rate• Burn-free cutting• Long life
<ul style="list-style-type: none">• High-strength, reinforced construction	<ul style="list-style-type: none">• Resists breakage and provides straight cuts

PART #	WHEEL SIZE	GRADING	MAX. RPM	WHEELS/ BOX
FOR STEEL/METAL FAST CUT				
05539509243	7 x 1/16 x 5/8	A36-TBFW	8,730	10
05539509249	7 x 3/32 x DM-5/8	A24-T	8,730	10
05539509238	8 x 1/16 x 5/8	A36-TBFW	7,640	10



TYPE 01



PREMIER REDCUT RIGHT ANGLE GRINDER REINFORCED CUT-OFF

Better Tier / Zirconia Alumina/Aluminum Oxide Blend



Excels on a broad range of materials, from alloys and stainless to gray iron.

FEATURES	BENEFITS
<ul style="list-style-type: none"> Premier performing zirconia alumina/aluminum oxide abrasive blend in a free cutting bond 	<ul style="list-style-type: none"> 3X the life and 2X the cut rate of standard aluminum oxide wheels Smooth cutting action that minimizes burn and burrs and operator fatigue Maximum productivity; lowest total grinding costs
<ul style="list-style-type: none"> Unique, high-strength, reinforced construction 	<ul style="list-style-type: none"> Provides strength for use on right angle grinders Flexible, resilient; resists breakage
<ul style="list-style-type: none"> Extra thin 	<ul style="list-style-type: none"> Less binding; quick cutting action

PART #	WHEEL SIZE	GRADING	MAX. RPM	WHEELS/ BOX
FOR STEEL/METAL/STAINLESS STEEL				
TYPE 01/41 – FOR RIGHT ANGLE GRINDERS				
05539566206	4-1/2 x .045 x 7/8	ZA60	13,580	25
05539566207	5 x .045 x 7/8	ZA60	12,225	25
05539566208	6 x .045 x 7/8	ZA60	10,185	25



TYPE 01/41

PART #	WHEEL SIZE	GRADING	MAX. RPM	WHEELS/ BOX
FOR STEEL/METAL/STAINLESS STEEL				
TYPE 27/42 – FOR RIGHT ANGLE GRINDERS				
66252844369	4-1/2 x .045 x 7/8	ZA60	13,580	25
66252844370	5 x .045 x 7/8	ZA60	12,225	25
66252844371	6 x .045 x 7/8	ZA60	10,185	25



TYPE 27/42

CARBO GOLDCUT RIGHT ANGLE GRINDER REINFORCED CUT-OFF

Good Tier / Aluminum Oxide



For general purpose cutting of stainless steel, steel and metal material with a right angle grinder.

FEATURES	BENEFITS
<ul style="list-style-type: none"> Quality aluminum oxide abrasive 	<ul style="list-style-type: none"> Fast stock removal Free cutting action
<ul style="list-style-type: none"> Advanced resin bond 	<ul style="list-style-type: none"> Long life, with no bounce
<ul style="list-style-type: none"> Unique, high-strength, reinforced construction 	<ul style="list-style-type: none"> Provides strength for use on right angle grinders Flexible, resilient; resists breakage
<ul style="list-style-type: none"> Extra thin .045" 	<ul style="list-style-type: none"> Less binding; quick cutting action

PART #	WHEEL SIZE	GRADING	MAX. RPM	WHEELS/ BOX
FOR STEEL/METAL				
TYPE 01/41 – FOR RIGHT ANGLE GRINDERS				
05539563951	4 x .045 x 5/8	A46-Q	15,280	25
05539527224	4 x 3/32 x 5/8	A36-Q	15,280	25
05539563952	4-1/2 x .045 x 7/8	A60-Q	13,580	25
05539527225	4-1/2 x 3/32 x 7/8	A60-Q	13,580	25
05539563953	5 x .045 x 7/8	A60-Q	12,225	25
05539527226	5 x 3/32 x 7/8	A60-Q	12,225	25
05539563954	6 x .045 x 7/8	A46-Q	10,185	25
05539527228	6 x 3/32 x 7/8	A60-Q	10,185	25
66252832324	7 x 1/16 x 7/8	A46-Q	8,600	25
05539527230	7 x 3/32 x 7/8	A46-Q	8,600	25

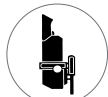

TYPE 01/41

PART #	WHEEL SIZE	GRADING	MAX. RPM	WHEELS/ BOX
FOR STEEL/METAL				
TYPE 27/42 – FOR RIGHT ANGLE GRINDERS				
66252844537	4 x .045 x 5/8	A30	13,580	20
66252830584	4-1/2 x .045 x 5/8-11	A30	13,580	20
05539561551	4-1/2 x .045 x 7/8	A30	13,580	20
66252844367	5 x .045 x 5/8-11	A30	12,225	20
05539561553	5 x .045 x 7/8	A30	12,225	20
66252844368	6 x .045 x 5/8-11	A30	10,185	20
05539561554	6 x .045 x 7/8	A30	10,185	20
05539561555	7 x 1/16 x 7/8	A30	8,600	20
66252830585	9 x 1/16 x 5/8-11	A30	6,600	10



TYPE 27/42



Economical choice for initial-price-conscious customers with general purpose applications.

FEATURES	BENEFITS
• Quality aluminum oxide abrasive	• Quick cutting action
• Extra thin	• Low kerf loss
• Low initial cost per wheel	• Ideal for on-site and small-unit jobs

PART #	WHEEL SIZE	GRADING	MAX. RPM	WHEELS/ BOX
FOR STEEL/METAL/STAINLESS STEEL				
TYPE 01/41 – FOR RIGHT ANGLE GRINDERS				
05539561584	4-1/2 x .040 x 7/8	A60	13,580	25
05539561585	5 x .040 x 7/8	A60	12,225	25
05539561586	6 x .040 x 7/8	A60	10,185	25
TYPE 27/42 – FOR RIGHT ANGLE GRINDERS				
66252836280	4-1/2 x .045 x 7/8	A60	13,580	20
66252836281	5 x .045 x 7/8	A60	12,225	20
66252836282	6 x .045 x 7/8	A60	10,185	20

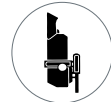

TYPE 01/41



TYPE 27/42

safetytip

Contact your machine vendor for proper flanges and guards when using ultra thin cut-off wheels on right angle grinders (less than 1/8" thick).



It is the user's responsibility to refer to and comply with ANSI B7.1



PREMIER RED STATIONARY SAW REINFORCED CUT-OFF WHEELS

Best Tier / Zirconia Alumina



For use on fixed-base machines.

FEATURES	BENEFITS
<ul style="list-style-type: none"> Premium, zirconia alumina abrasive 	<ul style="list-style-type: none"> Fastest cut rate on steel/metal Ideal for cutting stainless and high alloy steels
<ul style="list-style-type: none"> Resin bond 	<ul style="list-style-type: none"> Works best on dry cuts Most free cutting Longest wheel life Greatest productivity
<ul style="list-style-type: none"> High-strength, externally reinforced construction 	<ul style="list-style-type: none"> Resists breakage and provides straight cuts

PART #	WHEEL SIZE	GRADING	MAX. RPM	WHEELS/ BOX
FOR STEEL/METAL/STAINLESS STEEL				
05539507054	16 x 5/32 x 1	ZA30	3,820	10
05539507061	20 x 5/32 x 1	ZA30	2,710	5



CARBO GOLD STATIONARY SAW REINFORCED CUT-OFF WHEELS

Good Tier / Aluminum Oxide



For use on fixed-base machines.

FEATURES	BENEFITS
<ul style="list-style-type: none"> Aluminum oxide abrasive 	<ul style="list-style-type: none"> Fast cut rate on metal or steel
<ul style="list-style-type: none"> Resin bond 	<ul style="list-style-type: none"> Burn-free cutting For dry cuts Long life
<ul style="list-style-type: none"> High-strength, externally reinforced construction 	<ul style="list-style-type: none"> Resists breakage and provides straight cuts

PART #	WHEEL SIZE	GRADING	MAX. RPM	WHEELS/ BOX
FOR STEEL/METAL				
FAST CUT				
05539509216	10 x 3/32 x 5/8	A30	6,110	10
05539507069	12 x 1/8 x 1	A30	5,095	10
05539507070	14 x 1/8 x 1	A30	4,365	10
05539507071	16 x 5/32 x 1	A30	3,820	10
05539507072	20 x 5/32 x 1	A30	2,710	5
05539509204	20 x 3/16 x 1	A30	2,710	5
LONG LIFE				
05539507063	10 x 3/32 x 5/8	A24	6,110	10
05539507065	14 x 1/8 x 1	A24	4,365	10
05539507066	16 x 5/32 x 1	A24	3,820	10
05539507067	20 x 5/32 x 1	A24	2,710	5
05539507068	20 x 3/16 x 1	A24	2,710	5



techtip

- Run the cut-off machine at the "Maximum Operating Speed" marked on the wheel.
- A cut-off machine should have 1 horsepower for every inch of wheel diameter.
- With a less powerful machine, we recommend starting with a Fast Cut specification.
- Use Long Life wheels in high horsepower, aggressive applications.



It is the user's responsibility to refer to and comply with ANSI B7.1



PREMIER RED CHOP SAW REINFORCED CUT-OFF WHEELS

Best Tier / Zirconia Alumina



For use on table-top machines. Best choice for cutting light tubing, angle iron, exhaust pipes, steel extrusions, stainless, alloyed steel and many non-ferrous metals.

FEATURES	BENEFITS
<ul style="list-style-type: none"> Premium zirconia alumina abrasive 	<ul style="list-style-type: none"> Fast cut rate 2X the life of aluminum oxide wheels Ideal for cutting stainless steel
<ul style="list-style-type: none"> High performance resin bond 	<ul style="list-style-type: none"> Works best on dry cuts Most free cutting Long life; highest productivity
<ul style="list-style-type: none"> High-strength, externally reinforced construction 	<ul style="list-style-type: none"> Resists breakage and provides straight cuts

PART #	WHEEL SIZE	GRADING	MAX. RPM	WHEELS/ BOX
FOR STEEL/METAL/STAINLESS STEEL				
FAST CUT				
05539507079	12 x 3/32 x 1	ZA36	5,095	10
05539507080	14 x 3/32 x 1	ZA36	4,365	10
05539507083	16 x 3/32 x 1	ZA36	3,820	10
LONG LIFE				
05539507082	14 x 3/32 x 1	ZA36	4,365	10



TYPE 01

techtip

- Use Long Life chop saw wheels on machines rated 15 amps or higher.
- Use Fast Cut chop saw wheels on older, lower-powered machines.

CARBO GOLD CHOP SAW REINFORCED CUT-OFF WHEELS

Good Tier / Aluminum Oxide



For use on table-top machines. Ideal for cutting light tubing, angle iron, exhaust pipes and steel extrusions.

FEATURES	BENEFITS
<ul style="list-style-type: none"> Quality aluminum oxide abrasive 	<ul style="list-style-type: none"> Fast cut rate
<ul style="list-style-type: none"> Resin bond 	<ul style="list-style-type: none"> Burn-free cutting
<ul style="list-style-type: none"> High-strength, externally reinforced construction 	<ul style="list-style-type: none"> Resists breakage and provides straight cuts

PART #	WHEEL SIZE	GRADING	MAX. RPM	WHEELS/ BOX
FOR STEEL/METAL				
FAST CUT				
05539507087	14 x 3/32 x 1	A36	4,365	10
LONG LIFE				
05539507085	12 x 3/32 x 1	A36	5,095	10
05539507086	14 x 3/32 x 1	A36	4,365	10
05539507088	16 x 3/32 x 1	A36	3,820	10



TYPE 01

CARBO WHITE CHOP SAW REINFORCED CUT-OFF WHEELS

Standard Tier / Aluminum Oxide



Economical choice for initial-price-conscious customers with general purpose cut-off applications.

FEATURES	BENEFITS
<ul style="list-style-type: none"> Quality aluminum oxide abrasive 	<ul style="list-style-type: none"> Designed for cutting alloys, steels and ferrous metals
<ul style="list-style-type: none"> Low initial cost per wheel 	<ul style="list-style-type: none"> Ideal for on-site and small-unit jobs

PART #	WHEEL SIZE	GRADING	MAX. RPM	WHEELS/ BOX
FOR STEEL/METAL				
05539561581	12 x 3/32 x 1	A36-P	5,095	10
05539561582	14 x 3/32 x 1	A36-P	4,365	10
66252844372	16 x 3/32 x 1	A36-P	3,820	10



TYPE 01

CARBO GOLD HIGH-SPEED SAW REINFORCED CUT-OFF WHEELS

Good Tier / Aluminum Oxide

CARBO
GOLD™



Expanded Offering

For use on high-speed gas and electric saws to cut metal or steel.

FEATURES	BENEFITS
<ul style="list-style-type: none"> Aluminum oxide abrasive Resin bond 	<ul style="list-style-type: none"> Fast cut rate Burn-free cutting Long life
<ul style="list-style-type: none"> High-strength, reinforced construction 	<ul style="list-style-type: none"> Resists breakage; provides straight cuts

PART #	WHEEL SIZE	GRADING	MAX. RPM	WHEELS/ BOX
FOR STEEL/METAL – UNIVERSAL ARBOR				
66252837844	12 x 1/8 x 1"/20mm	A24	6,360	10
66252837845	14 x 1/8 x 1"/20mm	A24	5,400	10
66252842743	14 x 1/8 x 1"/20mm	A24 Heavy Duty	5,400	10 ●
66252844380	16 x 1/8 x 1"/20mm	A24	4,700	10

● = New Product



TYPE 01

CARBO GOLD HIGH-SPEED SAW REINFORCED CUT-OFF WHEELS

Good Tier / Silicon Carbide/Aluminum Oxide Blend

CARBO
GOLD™



For use on high-speed gas and electric saws to cut ductile iron, ultra-hard metals, hydraulic hose, and PVC pipe.

FEATURES	BENEFITS
<ul style="list-style-type: none"> Silicon carbide/aluminum oxide blend Resin bond 	<ul style="list-style-type: none"> Fast cut rate Free cutting action; long life Burn-free cutting
<ul style="list-style-type: none"> High-strength, reinforced construction 	<ul style="list-style-type: none"> Resists breakage; provides straight cuts

PART #	WHEEL SIZE	GRADING	MAX. RPM	WHEELS/ BOX
FOR DUCTILE IRON – UNIVERSAL ARBOR				
05539565134	12 x 1/8 x 1"/20mm	CA24	6,360	10
05539565136	14 x 1/8 x 1"/20mm	CA24	5,400	10
05539565138	16 x 1/8 x 1"/20mm	CA24	4,700	10



TYPE 01

CARBO GOLD HIGH-SPEED SAW REINFORCED CUT-OFF WHEELS

Good Tier / Silicon Carbide

CARBO
GOLD™



For use on high-speed gas and electric saws to cut concrete and masonry.

FEATURES	BENEFITS
<ul style="list-style-type: none"> Sharp, silicon carbide abrasive Resin bond 	<ul style="list-style-type: none"> Fast cut rate Free cutting action: long life Burn-free cutting
<ul style="list-style-type: none"> High-strength, reinforced construction 	<ul style="list-style-type: none"> Resists breakage; provides straight cuts

PART #	WHEEL SIZE	GRADING	MAX. RPM	WHEELS/ BOX
FOR CONCRETE/MASONRY – UNIVERSAL ARBOR				
66252837846	12 x 1/8 x 1"/20mm	C24	6,360	10
66252837847	14 x 1/8 x 1"/20mm	C24	5,400	10



TYPE 01

universalarbor

TWO BLADE SIZES IN ONE: Our patent-pending 1"/20mm knock-out arbor holes fit all gas and electric high speed saws. A 20mm bushing is pre-mounted into the 1" molded arbor hole. The wheel, with the 20mm bushing, can be mounted directly on any 20mm arbor high speed saw. Remove the 20mm bushing to mount on 1" arbor high speed saw. Plus heavy-duty triple reinforcing results in a higher performing wheel.



PREMIER RED FOUNDRY REINFORCED CUT-OFF WHEELS

Best Tier / Zirconia Alumina



Foundry cut-off wheels are used on chop stroke and locked-head push-through applications. Ideal for cutting off casting gates and risers.

FEATURES	BENEFITS
<ul style="list-style-type: none"> Premium zirconia alumina abrasive 	<ul style="list-style-type: none"> Fastest cut rate on high alloy steels, stainless steel, steel/metal
<ul style="list-style-type: none"> Resin bond 	<ul style="list-style-type: none"> Works best on dry cuts Most free cutting Longest wheel life Highest productivity
<ul style="list-style-type: none"> Internally reinforced wheels 	<ul style="list-style-type: none"> High strength; less kerf loss and provide straight cuts

PART #	WHEEL SIZE	GRADING	MAX. RPM	WHEELS/ BOX
IRON/STEEL/METAL/STAINLESS STEEL				
05539528045	24 x 7/32 x 1-3/4	2ZA244-VB35FIW	2,260	5



TYPE 01

CARBO GOLD FOUNDRY REINFORCED CUT-OFF WHEELS

Good Tier / Aluminum Oxide



Used on chop stroke and locked-head push-through applications. Ideal for cutting off casting gates and risers.

FEATURES	BENEFITS
<ul style="list-style-type: none"> Quality aluminum oxide abrasive 	<ul style="list-style-type: none"> Fast cut rate on ferrous and non-ferrous metals
<ul style="list-style-type: none"> Resin bond 	<ul style="list-style-type: none"> Free cutting action For dry cuts Long life
<ul style="list-style-type: none"> Internally reinforced wheels 	<ul style="list-style-type: none"> High strength; less kerf loss and provide straight cuts

PART #	WHEEL SIZE	GRADING	MAX. RPM	WHEELS/ BOX
FOR IRON/STEEL/METAL				
05539528046	24 x 3/16 x 1-3/4	RGA244-RBFIW	2,260	5
05539528047	26 x 7/32 x 1-3/4	RGA244-YB35FIW	2,090	5



TYPE 01



COMPETITIVE CROSS REFERENCE

CARBORUNDUM	3M	GEMTEX	HERMES	VSM	KLINGSPOR		
V 2549	983C, 984C, 988C	Ceramix	CB444X, CB444J	ZF713, SF750, SF840	–		
V 1247	501C, 785C	–	RB414X, CB444J, CB444X	KF715	CS565, CS566		
V 0947	381C	A	RB314X/J	KF708, KF808	CS561		
CARBORUNDUM	CAMEL	KLINGSPOR	WALTER	PFERD	SAIT	SIA	VSM
V 0947	A/O	CS561	CoolCut	A, A Cool	A, 2A	4919	KF708, KF808

STARTING RECOMMENDATIONS BY MATERIAL/APPLICATION

MATERIAL	HEAVY-DUTY BEST PERFORMANCE	GENERAL-DUTY
Carbon Steel	V 2549	V 1247
Stainless Steel/Alloys	V 2549, V 1247	
Cast Iron	V 2549	V 1247
Brass/Bronze	V 1247	
Aluminum	V 1247	
Fiberglass	V 2549	V 1247
Paint Removal and Clean-up	V 1247	

RECOMMENDED GRIT SELECTION

Rough/Heavy-Duty	Intermediate	Finishing
16–50	50–80	80–120

MEDALIST FIBER DISCS

Best Tier / Ceramic Alumina



The choice for all fiber disc grinding applications requiring aggressive cutting action, cool cut and long life. For hardest-to-grind materials.

FEATURES	BENEFITS
<ul style="list-style-type: none"> Ceramic alumina abrasive 	<ul style="list-style-type: none"> Sharper, cooler cutting abrasive continually exposing sharp points Fast cut rate with long life
<ul style="list-style-type: none"> Resin bond 	<ul style="list-style-type: none"> Increased strength, durability and grain adhesion
<ul style="list-style-type: none"> Heavy fiber backing 	<ul style="list-style-type: none"> Strength and tear resistance

PART #	GRADING		DISCS/PKG.	DISCS/CASE
4-1/2" x 7/8" INDIVIDUAL DISCS				
77696000101	24	V 2549	25	25
77696000102	36	V 2549	25	25
77696000103	50	V 2549	25	25
77696000104	60	V 2549	25	25
77696000105	80	V 2549	25	25
77696000106	100	V 2549	25	25
77696000107	120	V 2549	25	25
5" x 7/8" INDIVIDUAL DISCS				
77696000108	24	V 2549	25	25
77696000109	36	V 2549	25	25
77696000110	50	V 2549	25	25
77696000111	60	V 2549	25	25
77696000112	80	V 2549	25	25

PART #	GRADING		DISCS/PKG.	DISCS/CASE
7" x 7/8" INDIVIDUAL DISCS				
77696000113	24	V 2549	25	25
77696000114	36	V 2549	25	25
77696000115	50	V 2549	25	25
77696000116	60	V 2549	25	25
77696000117	80	V 2549	25	25
77696000118	100	V 2549	25	25
77696000119	120	V 2549	25	25
9-1/8" x 7/8" INDIVIDUAL DISCS				
77696000122	24	V 2549	25	25
77696000123	36	V 2549	25	25
77696000124	50	V 2549	25	25
77696000120	80	V 2549	25	25
77696000121	120	V 2549	25	25

See back-up pads for fiber discs on next page.



PREMIER RED FIBER DISCS

Better Tier / Ceramic Alumina / Zirconia Alumina Blend



Ideal for heavy-duty grinding of welds, gates, risers and parting lines on castings and carbon steels. The best choice for stainless steel and other hard-to-grind materials.

FEATURES	BENEFITS
<ul style="list-style-type: none"> Premium ceramic and high-performance zirconia alumina abrasive blend 	<ul style="list-style-type: none"> Longer life, especially on hard-to-grind materials Tough, aggressive yet cool cutting and self sharpening
<ul style="list-style-type: none"> Resin bond 	<ul style="list-style-type: none"> Increased strength, durability and grain adhesion
<ul style="list-style-type: none"> Heavy fiber backing 	<ul style="list-style-type: none"> Strength and tear resistance

PART #	GRADING		DISCS/PKG.	DISCS/CASE
4-1/2" x 7/8" INDIVIDUAL DISCS				
05539520088	24	V 1247	25	25
05539520087	36	V 1247	25	25
05539520086	50	V 1247	25	25
05539520034	60	V 1247	25	25
05539520019	80	V 1247	25	25
5" x 7/8" INDIVIDUAL DISCS				
05539510713	24	V 1247	25	25
05539510712	36	V 1247	25	25
05539510711	50	V 1247	25	25
05539520069	60	V 1247	25	25
05539520055	80	V 1247	25	25

PART #	GRADING		DISCS/PKG.	DISCS/CASE
7" x 7/8" INDIVIDUAL DISCS				
05539510722	24	V 1247	25	25
05539510721	36	V 1247	25	25
05539510720	50	V 1247	25	25
05539520077	60	V 1247	25	25
05539520076	80	V 1247	25	25

See back-up pads for fiber discs on next page.



CARBO WHITE FIBER DISCS

Standard Tier / Aluminum Oxide



Ideal for weld blending, deburring, stock removal, and rust removal.

FEATURES	BENEFITS
<ul style="list-style-type: none"> • High performance aluminum oxide 	<ul style="list-style-type: none"> • Low initial price with consistent performance
<ul style="list-style-type: none"> • Resin bond 	<ul style="list-style-type: none"> • Increased strength, durability and grain adhesion
<ul style="list-style-type: none"> • Heavy fiber backing 	<ul style="list-style-type: none"> • Strength and tear resistance

PART #	GRADING	DISCS/PKG.	DISCS/CASE
4" x 5/8" INDIVIDUAL DISCS			
77696000125	24 V 0947	25	25
77696000126	36 V 0947	25	25
77696000127	50 V 0947	25	25
77696000128	60 V 0947	25	25
77696000129	80 V 0947	25	25
4-1/2" x 7/8" INDIVIDUAL DISCS			
77696000130	24 V 0947	25	25
77696000131	36 V 0947	25	25
77696000132	50 V 0947	25	25
77696000133	60 V 0947	25	25
77696000134	80 V 0947	25	25
77696000135	100 V 0947	25	25
77696000136	120 V 0947	25	25
5" x 7/8" INDIVIDUAL DISCS			
77696000137	16 V 0947	25	25
77696000138	24 V 0947	25	25
77696000139	36 V 0947	25	25
77696000140	50 V 0947	25	25
77696000141	60 V 0947	25	25
77696000142	80 V 0947	25	25
77696000143	100 V 0947	25	25
77696009801	120 V 0947	25	25

PART #	GRADING	DISCS/PKG.	DISCS/CASE
7" x 7/8" INDIVIDUAL DISCS			
77696009802	16 V 0947	25	25
77696009804	24 V 0947	25	25
77696009805	36 V 0947	25	25
77696009806	50 V 0947	25	25
77696009807	60 V 0947	25	25
77696009808	80 V 0947	25	25
77696009809	100 V 0947	25	25
77696009810	120 V 0947	25	25
9-1/8" x 7/8" INDIVIDUAL DISCS			
77696009812	24 V 0947	25	25
77696009815	36 V 0947	25	25
77696009816	60 V 0947	25	25
77696009817	120 V 0947	25	25

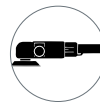

BACK-UP PADS FOR FIBER DISCS

Accessory



For all-purpose fiber disc sanding. Curved ribs on pad face reduce loading and allow for cooler cut. All pads have a threaded 5/8"-11 female hub.

PART #	DESCRIPTION	MAX. RPM	PADS/CASE
BACK-UP PADS FOR RESIN FIBER DISCS			
05539562582	4-1/2" Medium Air-Cooled	11,000	1
05539512033	5" Medium Air-Cooled	10,000	1
05539512032	7" Medium Air-Cooled	8,600	1

PAD NUT FOR FIBER DISCS

Accessory



Used to secure resin fiber discs to back-up pad.

PART #	DESCRIPTION	PAD NUTS/CASE
PAD NUT FOR RESIN FIBER DISCS		
05539512568	5/8"-11	1

PREMIER RED E-ZVIEW FLEX-LOC FIBER DISCS

Better Tier / Zirconia Alumina Blend



Ideal for heavy duty grinding of welds, gates, risers and parting lines on castings and carbon steels. The best choice for stainless steel. Strategically placed holes allow the operator to see the surface area being ground while the disc is spinning, enabling faster and more accurate work, and a superior finish.

FEATURES	BENEFITS
• High performance zirconia alumina abrasive blend	• Long life, especially on hard-to-grind materials
• Resin bond	• Ultra tough, aggressive, yet cool cutting, and self sharpening
• Heavy fiber backing	• Increased strength, durability and grain adhesion
• Round edge shape	• Strength and tear resistance
• Scooped holes	• Ideal for reaching into grooves, sharp edges, and hard-to-grind corners where work is done at a steeper angle
• Flex-Loc mount	• Create air flow to remove swarf – preventing loading – and a 30% cooler cutting action than conventional discs
	• Quick, tool-free changing of discs

PART #	GRADING		DISCS/PKG.	DISCS/CASE
4-1/2" E-ZVIEW FLEX-LOC FIBER INDIVIDUAL DISCS				
05539563969	24	V 1247	10	40
05539563970	36	V 1247	10	40
05539563971	50	V 1247	10	40
5" E-ZVIEW FLEX-LOC FIBER INDIVIDUAL DISCS				
05539562966	24	V 1247	10	40
05539562967	36	V 1247	10	40
05539562968	50	V 1247	10	40
05539562969	60	V 1247	10	40
05539562970	80	V 1247	10	40



15°

BACK-UP PADS FOR E-ZVIEW FLEX-LOC DISCS

Accessory



Designed exclusively for use with E-ZView Flex-Loc discs. These back-up pads allow easy, tool-free mounting. The mounting hole and recessed lock-nut automatically line disc up with back-up pad and allow more disc to contact work surface.

PART #	DESCRIPTION	MAX. RPM	PADS/CASE
BACK-UP PADS FOR E-ZVIEW FLEX-LOC DISCS			
05539563975	4-1/2 x 5/8"-11 Sawtooth	13,000	5
05539563019	5 x 5/8"-11 Sawtooth	13,000	5
05539563395	5 x 7/16"-20 Pistol Grip Sawtooth	20,000	5

Say Goodbye to Guesswork. Put Your Surface in Easy View.

E-ZView is our patented abrasive product for portable right angle grinders. Strategically positioned holes allow the operator to see the surface area being ground, while the disc is spinning. Being able to see the surface while grinding enables an operator to reduce gouging, work faster and more accurately, and produce a superior finish.





FLAP DISC SHAPES



GRIND AT FLATTER ANGLES:
0° – 15°

TYPE 27 FLAT – THE BEST CHOICE FOR FINISHING

Used primarily on flat surfaces.

The best choice for blending and smooth finishing.



GRIND AT STEEPER ANGLES:
15° – 25°

TYPE 29 CONICAL – THE BEST CHOICE FOR AGGRESSIVE STOCK REMOVAL

Conical flap discs have angled flaps and may be used on both contoured and edge work.

The angle provides greater surface contact for stock removal on flat surfaces.

The best choice when speed and stock removal are primary considerations.

ABRASIVE FLAP DENSITIES



STANDARD DENSITY

Excellent for heavy-duty applications and rapid stock removal.



HIGH DENSITY FAT BOY

Ideal when working on uneven or curved surfaces, as well as finer grit blending.

BACKING PLATE MATERIALS

All flap discs are a combination of abrasive flaps adhered to a rigid backing plate. It is the backing plate that provides stability during operation. There are two main materials used: fiberglass and plastic. The fiberglass backing plate, along with the flap shape, helps to absorb vibration and is consumed during use with no smearing. Fiberglass is the most popular material because of its high strength and light weight.

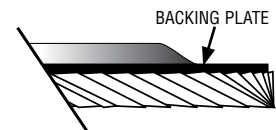

WHY CHOOSE FLAP DISCS?

Flap discs replace both grinding wheels and fiber discs. The same flap disc can be used for applications ranging from stock removal to blending.

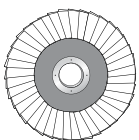

Flap Discs vs. Grinding Wheels

- Faster stock removal
- Smoother finish, no gouging
- Cooler cutting, less glazing
- Lightweight, easier to control
- Less vibration, less operator fatigue
- Reduced noise

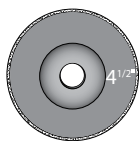

4 1/2"

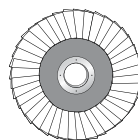

Flap Discs vs. Fiber Discs

- 20X longer life, reduced abrasive cost
- Fewer disc changes, reduced labor cost
- More consistent finish
- No back-up pad required
- Easier storage, no curling
- Reduced loading
- Use flap discs one grit size coarser than fiber discs, except in 36 grit

techtip

- Use one grit size coarser than fiber discs, except in 36 grit.
- Operate Type 29 (regular and Fat Boy) flap discs at a 15° – 25° angle; operate Type 27 (Regular, Plastic and Fat Boy) flap discs at an angle less than 15°; more severe angles will weaken flap edges.



It is the user's responsibility to refer to and comply with ANSI B7.7



APPLICATION/GRIT RECOMMENDATION GUIDE

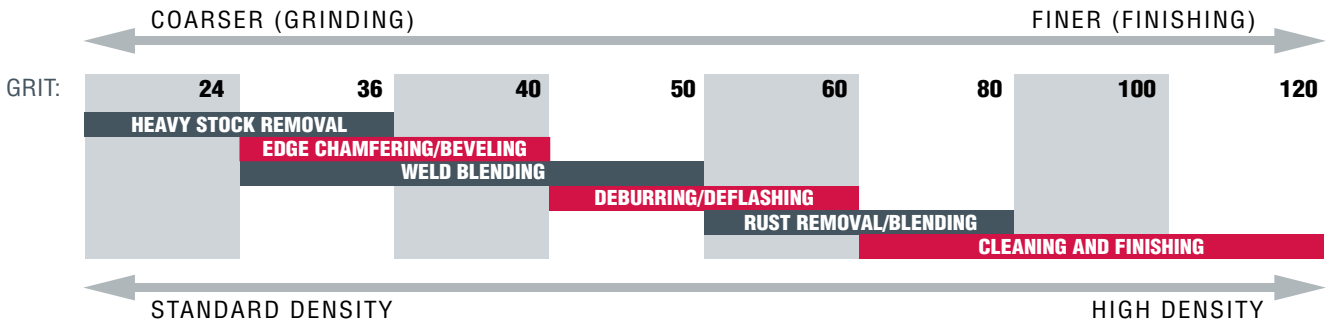

COMPETITIVE CROSS REFERENCE

CARBORUNDUM	DEWALT	GARRYSON	GEMTEX	KLINGSPOR	PFERD	SAIT	3M	WALTER	WEILER	CAMEL
Medalist YP 2079 W	–	Zirc+	Ceramic	–	Ceramic	–	947D, 967A	Enduroflex Ceramic	Saber Tooth Ceramic	C3
Premier Red XC 1176	–	Zirc	Zirc	SMT 630	Cool Zirconia	Saitlam F ZH	563D, 546D	Enduroflex Zirconia	Tiger Zirconia	Z-Stainless
White XB 1186	Zirc			SMT 618	Zirconia				Votec	Z-3

STARTING RECOMMENDATIONS BY MATERIAL/APPLICATION

MATERIAL	HEAVY DUTY	FINE FINISHES
Stainless steel and other hard to grind materials	YP 2079 W - Type 27	YP 2079 W - Type 27
Carbon and softer to grind materials	XC 1176 – Type 29	XC 1176 - Type 27
Initial price	XB 1186 - Type 29	XB 1186 - Type 27

MEDALIST FLAP DISCS

Best Tier / Ceramic Alumina Resin Cloth

CARBO™
MEDALIST™



Ideal for aggressive cutting action, cool cut and longer life on harder-to-grind materials.

FEATURES	BENEFITS
<ul style="list-style-type: none"> Grind and finish at the same time 	<ul style="list-style-type: none"> No switching from depressed center wheel to resin fiber disc
<ul style="list-style-type: none"> Fit same type grinder as resin fiber disc and depressed center wheel 	<ul style="list-style-type: none"> Eliminates need for special tools
<ul style="list-style-type: none"> High-performance blend of ceramic and zirconia abrasives 	<ul style="list-style-type: none"> Requires less pressure to work at maximum performance
<ul style="list-style-type: none"> Type 27 Plastic – flat face, plastic back 	<ul style="list-style-type: none"> Plastic back wears away with abrasives for longer life More forgiving than Type 29 – producing smooth finishes

PART #	GRADING	MAX. RPM	DISCS/PKG.	DISCS/CASE
4-1/2" x 5/8"-11 NUT – TYPE 27 PLASTIC				
66623326212	40	YP 2079 W	13,300	10
66623326217	60	YP 2079 W	13,300	10
66623326218	80	YP 2079 W	13,300	10
4-1/2" x 7/8" – TYPE 27 PLASTIC				
05539567811	40	YP 2079 W	13,300	10
05539567812	60	YP 2079 W	13,300	10
05539567813	80	YP 2079 W	13,300	10
5" x 5/8"-11 NUT – TYPE 27 PLASTIC				
66623326219	40	YP 2079 W	12,000	10
66623326220	60	YP 2079 W	12,000	10
66623326221	80	YP 2079 W	12,000	10
5" x 7/8" – TYPE 27 PLASTIC				
05539570054	40	YP 2079 W	12,000	10
05539570055	60	YP 2079 W	12,000	10
05539570056	80	YP 2079 W	12,000	10

PART #	GRADING	MAX. RPM	DISCS/PKG.	DISCS/CASE
7" x 5/8"-11 NUT – TYPE 27 PLASTIC				
66623326222	40	YP 2079 W	8,600	10
66623326223	60	YP 2079 W	8,600	10
66623326233	80	YP 2079 W	8,600	10
7" x 7/8" – TYPE 27 PLASTIC				
05539570057	40	YP 2079 W	8,600	10
05539570058	60	YP 2079 W	8,600	10
05539570059	80	YP 2079 W	8,600	10



TYPE 27



Ideal for metal grinding or polishing, especially for weld bead grinding on fine carbon and stainless steel.

FEATURES	BENEFITS
<ul style="list-style-type: none"> Grind and finish at the same time 	<ul style="list-style-type: none"> No switching from depressed center wheel to resin fiber disc
<ul style="list-style-type: none"> Fit same type grinder as resin fiber disc and depressed center wheel 	<ul style="list-style-type: none"> Eliminates need for special tools
<ul style="list-style-type: none"> Type 29 Fiberglass – conical, slightly concaved design Increased area of contact 	<ul style="list-style-type: none"> Built-in grinding angle minimizes workpiece gouging Aggressive action, high stock removal rates Ideal for flat surfaces Excellent on soft metals; increased versatility Best choice when speed is the main consideration
<ul style="list-style-type: none"> Type 27 Fiberglass – flat face 	<ul style="list-style-type: none"> More forgiving than Type 29 Ideal for finishing intricate parts
<ul style="list-style-type: none"> Fat Boy – thicker with more flaps 	<ul style="list-style-type: none"> Up to 40% longer life than standard flap discs Produces a smooth finish on shapes and irregular surfaces
<ul style="list-style-type: none"> Fat Boy Type 27 Fiberglass Fat Boy Type 29 Fiberglass 	<ul style="list-style-type: none"> Aggressive action, high stock removal rates Ideal when added performance and longer life are required
<ul style="list-style-type: none"> Available with 5-8"-11 nut 	<ul style="list-style-type: none"> Less down time for disc changes

TYPE 27 – FIBERGLASS BACK

PART #	GRADING	MAX. RPM	DISCS/PKG.	DISCS/CASE
4-1/2" x 5/8"-11 NUT – TYPE 27 FIBERGLASS				
05539564060	36 XC 1176	13,300	5	5
05539564061	40 XC 1176	13,300	5	5
05539564062	60 XC 1176	13,300	5	5
05539564063	80 XC 1176	13,300	5	5
4-1/2" x 7/8" – TYPE 27 FIBERGLASS				
05539563741	36 XC 1176	13,000	5	5
05539563742	40 XC 1176	13,000	5	5
05539563743	60 XC 1176	13,000	5	5
05539563744	80 XC 1176	13,000	5	5
05539563745	120 XC 1176	13,000	5	5
7" x 5/8"-11 NUT – TYPE 27 FIBERGLASS				
05539564056	36 XC 1176	8,600	5	5
05539564057	40 XC 1176	8,600	5	5
05539564058	60 XC 1176	8,600	5	5
7" x 7/8" – TYPE 27 FIBERGLASS				
05539563746	36 XC 1176	8,600	5	5
05539563747	40 XC 1176	8,600	5	5
05539563748	60 XC 1176	8,600	5	5
4-1/2" x 5/8"-11 NUT – TYPE 27 FAT BOY FIBERGLASS				
66261068838	40 XC 1176	13,300	5	5
66261068846	60 XC 1176	13,300	5	5
66261068848	80 XC 1176	13,300	5	5
4-1/2" x 7/8" – TYPE 27 FAT BOY FIBERGLASS				
05539563929	40 XC 1176	13,300	5	5
05539563930	60 XC 1176	13,300	5	5
05539563931	80 XC 1176	13,300	5	5
7" x 5/8"-11 NUT – TYPE 27 FAT BOY FIBERGLASS				
05539570542	40 XC 1176	8,600	5	5
05539570544	80 XC 1176	8,600	5	5

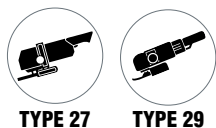

TYPE 27

TYPE 29

TYPE 29 – FIBERGLASS BACK

PART #	GRADING	MAX. RPM	DISCS/PKG.	DISCS/CASE
4" x 5/8" – TYPE 29 FIBERGLASS				
05539518617	36 XC 1176	15,300	5	5
05539518616	40 XC 1176	15,300	5	5
05539518615	60 XC 1176	15,300	5	5
05539518613	80 XC 1176	15,300	5	5
05539518610	120 XC 1176	15,300	5	5
4-1/2" x 5/8"-11 NUT – TYPE 29 FIBERGLASS				
05539520348	36 XC 1176	13,300	5	5
05539520347	40 XC 1176	13,300	5	5
05539520346	60 XC 1176	13,300	5	5
05539520345	80 XC 1176	13,300	5	5
4-1/2" x 7/8" – TYPE 29 FIBERGLASS				
05539518624	24 XC 1176	13,300	5	5
05539518623	36 XC 1176	13,300	5	5
05539518622	40 XC 1176	13,300	5	5
05539518621	60 XC 1176	13,300	5	5
05539518620	80 XC 1176	13,300	5	5
05539518619	120 XC 1176	13,300	5	5
5" x 7/8" – TYPE 29 FIBERGLASS				
05539518629	36 XC 1176	12,000	5	5
05539518628	40 XC 1176	12,000	5	5
05539518627	60 XC 1176	12,000	5	5
05539518626	80 XC 1176	12,000	5	5
7" x 5/8"-11 NUT – TYPE 29 FIBERGLASS				
05539518642	24 XC 1176	8,600	5	5
05539518641	36 XC 1176	8,600	5	5
05539518640	40 XC 1176	8,600	5	5
05539518639	60 XC 1176	8,600	5	5
05539518638	80 XC 1176	8,600	5	5
7" x 7/8" – TYPE 29 FIBERGLASS				
05539518635	36 XC 1176	8,600	5	5
05539518634	40 XC 1176	8,600	5	5
05539518633	60 XC 1176	8,600	5	5
05539518632	80 XC 1176	8,600	5	5
05539518631	120 XC 1176	8,600	5	5
4-1/2" x 5/8"-11 NUT – TYPE 29 FAT BOY FIBERGLASS				
05539570539	40 XC 1176	13,300	5	5
05539570540	60 XC 1176	13,300	5	5
05539570541	80 XC 1176	13,300	5	5



New lower-priced stock offering for jobs where performance is not measurable.

FEATURES	BENEFITS
<ul style="list-style-type: none"> Grind and finish at the same time 	<ul style="list-style-type: none"> No switching from depressed center wheel to resin fiber disc
<ul style="list-style-type: none"> Fit same type grinder as resin fiber disc and depressed center wheel 	<ul style="list-style-type: none"> Eliminates need for special tools
<ul style="list-style-type: none"> Quality zirconia alumina abrasive 	<ul style="list-style-type: none"> Good cut rate and life
<ul style="list-style-type: none"> Low initial price point 	<ul style="list-style-type: none"> Best starting specification for end-user unable to measure performance
<ul style="list-style-type: none"> Type 27 Plastic – flat face, plastic back 	<ul style="list-style-type: none"> Plastic back wears away with abrasives for longer life
<ul style="list-style-type: none"> NEW! Type 29 Fiberglass – angled face, slightly concaved design Increased area of contact 	<ul style="list-style-type: none"> Built-in angle for grinding minimizes workpiece gouging Aggressive action, high stock removal rates Ideal for flat surfaces Excellent on soft metals; increased versatility Best choice when speed is the main consideration
<ul style="list-style-type: none"> Available with 5-8" -11 nut 	<ul style="list-style-type: none"> Less down time for disc changes

TYPE 27 – PLASTIC BACK

PART #	GRADING	MAX. RPM	DISCS/PKG.	DISCS/CASE
4-1/2" x 5/8"-11 NUT – TYPE 27 PLASTIC				
77696002060	40 XB 1186	13,300	10	10
77696002062	60 XB 1186	13,300	10	10
77696002063	80 XB 1186	13,300	10	10
77696002064	120 XB 1186	13,300	10	10
4-1/2" x 7/8" – TYPE 27 PLASTIC				
77696002077	40 XB 1186	13,300	10	10
77696002078	60 XB 1186	13,300	10	10
77696002079	80 XB 1186	13,300	10	10
77696002080	120 XB 1186	13,300	10	10
5" x 5/8"-11 NUT – TYPE 27 PLASTIC				
77696002065	40 XB 1186	12,000	10	10
77696002068	60 XB 1186	12,000	10	10
77696002070	80 XB 1186	12,000	10	10
77696002071	120 XB 1186	12,000	10	10
5" x 7/8" – TYPE 27 PLASTIC				
77696002081	40 XB 1186	12,000	10	10
77696002082	60 XB 1186	12,000	10	10
77696002083	80 XB 1186	12,000	10	10
77696002084	120 XB 1186	12,000	10	10
7" x 7/8"-11 NUT – TYPE 27 PLASTIC				
77696002072	40 XB 1186	8,600	10	10
77696002073	60 XB 1186	8,600	10	10
77696002075	80 XB 1186	8,600	10	10
77696002076	120 XB 1186	8,600	10	10
7" x 7/8" – TYPE 27 PLASTIC				
77696002086	40 XB 1186	8,600	10	10
77696002088	60 XB 1186	8,600	10	10
77696002092	80 XB 1186	8,600	10	10
77696002093	120 XB 1186	8,600	10	10

FIBERGLASS BACK

PART #	GRADING	MAX. RPM	DISCS/PKG.	DISCS/CASE
4-1/2 x 5/8-11 NUT - TYPE 29 FIBERGLASS				
77696090095	40 XB 1186	13,000	10	10 ●
77696090096	60 XB 1186	13,000	10	10 ●
77696090097	80 XB 1186	13,000	10	10 ●
77696090098	120 XB 1186	13,000	10	10 ●
4-1/2 x 7/8 - TYPE 29 FIBERGLASS				
77696090099	40 XB 1186	13,000	10	10 ●
77696090100	60 XB 1186	13,000	10	10 ●
77696090101	80 XB 1186	13,000	10	10 ●
77696090102	120 XB 1186	13,000	10	10 ●
5 x 5/8-11 NUT - TYPE 29 FIBERGLASS				
77696090103	40 XB 1186	12,000	10	10 ●
77696090104	60 XB 1186	12,000	10	10 ●
77696090105	80 XB 1186	12,000	10	10 ●
77696090106	120 XB 1186	12,000	10	10 ●
5 x 7/8 - TYPE 29 FIBERGLASS				
77696090107	40 XB 1186	12,000	10	10 ●
77696090108	60 XB 1186	12,000	10	10 ●
77696090109	80 XB 1186	12,000	10	10 ●
77696090110	120 XB 1186	12,000	10	10 ●
7 x 5/8-11 NUT - TYPE 29 FIBERGLASS				
77696090111	40 XB 1186	8,600	10	10 ●
77696090112	60 XB 1186	8,600	10	10 ●
77696090113	80 XB 1186	8,600	10	10 ●
77696090114	120 XB 1186	8,600	10	10 ●
7 x 7/8 - TYPE 29 FIBERGLASS				
77696090115	40 XB 1186	8,600	10	10 ●
77696090116	60 XB 1186	8,600	10	10 ●
77696090117	80 XB 1186	8,600	10	10 ●
77696090118	120 XB 1186	8,600	10	10 ●

● = New Product

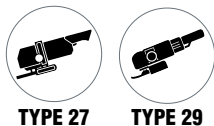

PREMIER RED MINI FLAP DISCS

Better Tier / Zirconia Alumina Resin Cloth



Ideal for metal grinding and polishing, especially for weld bead grinding on fine carbon and stainless steel; for small areas of contact.

FEATURES	BENEFITS
<ul style="list-style-type: none"> • High performance zirconia alumina abrasive 	<ul style="list-style-type: none"> • Provides maximum cut rate and life
<ul style="list-style-type: none"> • Layered flaps wear away evenly 	<ul style="list-style-type: none"> • Produces a high quality and consistent finish
<ul style="list-style-type: none"> • Available in 2" and 3" diameters 	<ul style="list-style-type: none"> • Ability to get into tight areas while maintaining required cut and life
<ul style="list-style-type: none"> • TS (Type II) and TR (Type III) attachment systems 	<ul style="list-style-type: none"> • Easy-on; easy off attachment for quick disc changes



TYPE TS (TYPE II)

PART #	GRADING		DISCS/PKG.	DISCS/CASE
2"				
77696090119	36	XC 1176	10	10
77696090121	40	XC 1176	10	10
77696090123	60	XC 1176	10	10
77696090125	80	XC 1176	10	10
77696090127	120	XC 1176	10	10
3"				
77696090129	36	XC 1176	10	10
77696090131	40	XC 1176	10	10
77696090133	60	XC 1176	10	10
77696090135	80	XC 1176	10	10
77696090137	120	XC 1176	10	10

TYPE TR (TYPE III)

PART #	GRADING		DISCS/PKG.	DISCS/CASE
2"				
77696090120	36	XC 1176	10	10
77696090122	40	XC 1176	10	10
77696090124	60	XC 1176	10	10
77696090126	80	XC 1176	10	10
77696090128	120	XC 1176	10	10
3"				
77696090130	36	XC 1176	10	10
77696090132	40	XC 1176	10	10
77696090134	60	XC 1176	10	10
77696090136	80	XC 1176	10	10
77696090138	120	XC 1176	10	10



BACK-UP PADS FOR MINI FLAP DISCS

Accessory

Easy-on; easy off attachment for quick disc changes



PART #	DESCRIPTION	MAX. RPM	PADS/CASE
BACK-UP PADS FOR MINI FLAP DISCS			
08834168539	2" and 3" TS (Type II) Back-up Pads	30,000	1
08834164922	2" and 3" TR (Type III) Back-up Pads	30,000	1



STICK-ON PAPER DISC COMPETITIVE CROSS REFERENCE

CARBORUNDUM	3M	HERMES	KLINGSPOR	MIRKA	SIA	VSM
PAPER DISCS						
B 2312 DO, C 2312 DO	735U, 734U	–	PS36	–	1950 Siaspeed	–
B 0912 DO, B 0712 DO	216U, 255L, 260L, 334U	VC154-LL	PS73	Q-Silver, Royal	1950, 1940	MPG
C 0712 DO, PB273	236U, 316U, Red, NX	HCAB, HC135-LL, VC151-LL	PS33, PL36	Bulldog Gold, BaseCut	1947	KP911, MP10
B 0412 DO	414N, 415N, 415U, 426U	PSF-LL, SA168	PL35	CaratFlex, PolarStar	1748	CP131A
E 1214 O	750U, 751U, 740I, 745I	–	–	Royal Coarse Cut	–	KP510E, KP709

TYPES OF DISC PACKAGING



LINK DISC ROLL

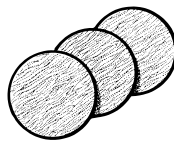

INDIVIDUAL DISCS

MEDALIST STICK-ON PAPER DISCS

Best Tier / Ceramic Alumina Dri-Lube Resin Paper Open



Best choice for stripping and preparing primed and painted surfaces for finishing, sanding of plastics, fiberglass, and composites, bare wood sanding, light weld blending, preparing and finishing metal, and sanding of all gel coats and body filler compounds.

FEATURES	BENEFITS
<ul style="list-style-type: none"> Medalist ceramic alumina abrasive, P80 - P800 	<ul style="list-style-type: none"> Fastest cut rate even on hard-to-sand surfaces Extended life – up to 2:1 over conventional discs Broadest ceramic grit range available
<ul style="list-style-type: none"> Full resin bond system 	<ul style="list-style-type: none"> Improved grain adhesion and longest disc life
<ul style="list-style-type: none"> Unique fiber-reinforced, flexible B- and C-weight latex-saturated backing 	<ul style="list-style-type: none"> 50% - 60% improvement in tear resistance, superior resistance to delamination Durable, yet flexible
<ul style="list-style-type: none"> Special undyed stearate oversize 	<ul style="list-style-type: none"> Superior load resistance and extended life No color transfer to work
<ul style="list-style-type: none"> PSA (pressure sensitive adhesive) backing 	<ul style="list-style-type: none"> Easy application and removal
<ul style="list-style-type: none"> Link disc roll, 4-pack with polybags 	<ul style="list-style-type: none"> Easy dispensing Minimizes storage space

PART #	GRADING	ROLLS/CASE
6" x 0" LINK DISC ROLLS		
05539599500	P80 C 2312 DO	4
05539599499	P100 C 2312 DO	4
05539599498	P120 C 2312 DO	4
05539599497	P150 B 2312 DO	4
05539599496	P180 B 2312 DO	4

PART #	GRADING	ROLLS/CASE
6" x 0" LINK DISC ROLLS		
05539599495	P220 B 2312 DO	4
05539599494	P240 B 2312 DO	4
05539599493	P280 B 2312 DO	4
05539599492	P320 B 2312 DO	4
05539599491	P400 B 2312 DO	4
05539599490	P500 B 2312 DO	4
05539599489	P600 B 2312 DO	4
05539599488	P800 B 2312 DO	4

Link Disc Rolls: 100 discs per roll. Order in multiples of 4 rolls.



See back-up pads for these discs on page 32.
Disc roll dispenser available on page 36.



Best choice for sanding all paints, primers, plastics and fiberglass. Also suited for sealer and wash coats in wood furniture.

FEATURES	BENEFITS
<ul style="list-style-type: none"> • P-graded, heat-treated, aluminum oxide abrasive 	<ul style="list-style-type: none"> • 30% to 50% faster cut rate than other discs • Consistent scratch pattern and finish
<ul style="list-style-type: none"> • Full resin bond system 	<ul style="list-style-type: none"> • Improved grain adhesion and longest disc life
<ul style="list-style-type: none"> • Unique fiber-reinforced, B-weight, latex-saturated backing 	<ul style="list-style-type: none"> • 50% – 60% improvement in tear strength, superior resistance to delamination
<ul style="list-style-type: none"> • PSA (pressure sensitive adhesive) backing 	<ul style="list-style-type: none"> • Easy application and removal
<ul style="list-style-type: none"> • Special, undyed stearate oversize and an open coat 	<ul style="list-style-type: none"> • Superior load resistance and extended life • No color transfer to work
<ul style="list-style-type: none"> • Link disc roll, 4-pack with polybags 	<ul style="list-style-type: none"> • Easy dispensing • Minimizes storage space
<ul style="list-style-type: none"> • 5" and 6" individual PSA discs have a tabbed, white, translucent liner 	<ul style="list-style-type: none"> • The PSA adhesive is protected from air-borne contaminants • The tab allows easier removal of the paper liner

PART #	GRADING	ROLLS/CASE	MIN. QTY.
3-1/2" x 0" LINK DISC ROLLS			
05539520624	P80 B 0912 DO	4	4
05539520623	P100 B 0912 DO	4	4
05539520620	P180 B 0912 DO	4	4
05539520619	P220 B 0912 DO	4	4
05539520615	P400 B 0912 DO	4	4
5" x 0" LINK DISC ROLLS			
05539518114	P80 B 0912 DO	4	4
05539518113	P100 B 0912 DO	4	4
05539518112	P120 B 0912 DO	4	4
05539518111	P150 B 0912 DO	4	4
05539518110	P180 B 0912 DO	4	4
05539518109	P220 B 0912 DO	4	4
05539518108	P240 B 0912 DO	4	4
05539518107	P280 B 0912 DO	4	4
05539518106	P320 B 0912 DO	4	4
05539518105	P400 B 0912 DO	4	4
05539563779	P500 B 0912 DO	4	4
05539518104	P600 B 0912 DO	4	4
05539518101	P800 B 0712 DO	4	4
PART #	GRADING	DISCS/PKG.	DISCS/CASE
5" x 0" INDIVIDUAL TABBED DISCS			
05539520293	P1000 B 0712 DO	100	400
05539520292	P1200 B 0712 DO	100	400
05539520291	P1500 B 0712 DO	100	400

PART #	GRADING	ROLLS/CASE	MIN. QTY.
6" x 0" LINK DISC ROLLS			
05539518173	P80 B 0912 DO	4	4
05539518172	P100 B 0912 DO	4	4
05539518171	P120 B 0912 DO	4	4
05539518170	P150 B 0912 DO	4	4
05539518169	P180 B 0912 DO	4	4
05539518168	P220 B 0912 DO	4	4
05539518167	P240 B 0912 DO	4	4
05539518166	P280 B 0912 DO	4	4
05539518165	P320 B 0912 DO	4	4
05539518164	P400 B 0912 DO	4	4
05539563780	P500 B 0912 DO	4	4
05539518163	P600 B 0912 DO	4	4
05539518162	P800 B 0712 DO	4	4
PART #	GRADING	DISCS/PKG.	DISCS/CASE
6" x 0" INDIVIDUAL TABBED DISCS			
05539520296	P1000 B 0712 DO	100	400
05539520295	P1200 B 0712 DO	100	400
05539520294	P1500 B 0712 DO	100	400
PART #	GRADING	ROLLS/CASE	MIN. QTY.
8" x 0" LINK DISC ROLLS			
05539561110	P80 B 0912 DO	4	4
05539561109	P100 B 0912 DO	4	4
05539561108	P120 B 0912 DO	4	4
05539561106	P180 B 0912 DO	4	4
05539561102	P320 B 0912 DO	4	4

Link Disc Rolls: 100 discs per roll. Order in multiples of 4 rolls.



See back-up pads for these discs on page 32.
Disc roll dispenser available on page 36.

CARBO GOLD STICK-ON PAPER DISCS

Good Tier / Aluminum Oxide Dri-Lube Resin Paper Open



Ideal for sanding paints, primers, plastics and fiberglass as well as whitewood sanding, clean-up and repair.

FEATURES	BENEFITS
• Premium, P-graded, light brown aluminum oxide abrasive	• Fast cut, long life
• Full resin bond system	• Improved grain adhesion and longest disc life
• Durable, C-weight backing	• High tear resistance
• PSA (pressure sensitive adhesive) backing	• Easy application and removal
• Special, water-based stearate oversize and open coat	• Excellent load resistance
• Link disc roll; 4-pack with polybags	• Easy dispensing; protects individual rolls
	• Minimizes storage space

PART #	GRADING	ROLLS/CASE	MIN. QTY.
5" x 0" LINK DISC ROLLS			
05539510555	P80 C 0712 DO	4	4
05539510554	P100 C 0712 DO	4	4
05539510553	P120 C 0712 DO	4	4
05539510552	P150 C 0712 DO	4	4
05539510550	P180 C 0712 DO	4	4
05539510549	P220 C 0712 DO	4	4
05539510548	P240 C 0712 DO	4	4
05539510546	P320 C 0712 DO	4	4
05539510545	P400 C 0712 DO	4	4

PART #	GRADING	ROLLS/CASE	MIN. QTY.
6" x 0" LINK DISC ROLLS			
05539510567	P80 C 0712 DO	4	4
05539510566	P100 C 0712 DO	4	4
05539510565	P120 C 0712 DO	4	4
05539510563	P150 C 0712 DO	4	4
05539510562	P180 C 0712 DO	4	4
05539510561	P220 C 0712 DO	4	4
05539510560	P240 C 0712 DO	4	4
05539510558	P320 C 0712 DO	4	4
05539510557	P400 C 0712 DO	4	4

100 discs per roll. Order in multiples of 4 rolls.



MERIT PB273 STICK-ON PAPER DISCS

Good Tier / Aluminum Oxide Dri-Lube Resin Paper Open



Good choice for sanding paint, primer, plastics, and fiberglass, as well as whitewood sanding, clean-up, and repair – at a low initial price.

FEATURES	BENEFITS
• P-graded, sharp, light-brown aluminum oxide abrasive	• Fast cut rate, extended life, and consistent finish
• Full resin bond system	• Improved grain adhesion and longest disc life
• Premium B-weight latex-saturated, high-internal-bond paper backing	• Improved resistance to delamination
• Water-based stearate anti-loading oversize and an open coat	• Improved load resistance on a broad range of substrates
• PSA (pressure sensitive adhesive) backing	• Easy application and removal
• Link disc roll, 4-pack with polybags	• Easy dispensing;
	• Minimizes storage space
• 5" individual PSA discs have an easy-to-remove tabbed white translucent liner	• The PSA adhesive is protected from air-borne contaminants

PART #	GRADING	ROLLS/CASE	MIN. QTY.
5" x 0" LINK DISC ROLLS			
66623362930	P80 PB273	4	4
66623362929	P120 PB273	4	4
66623362928	P150 PB273	4	4
66623362927	P180 PB273	4	4
66623362926	P220 PB273	4	4
66623362925	P240 PB273	4	4
66623362924	P320 PB273	4	4

PART #	GRADING	ROLLS/CASE	MIN. QTY.
5" x 0" LINK DISC ROLLS			
66623362923	P400 PB273	4	4
66623362922	P600 PB273	4	4
66623362921	P800 PB273	4	4

100 discs per roll. Order in multiples of 4 rolls. Continued on next page.



PART #	GRADING		ROLLS/CASE	MIN. QTY.
5" x 0" INDIVIDUAL TABBED DISCS				
69957348198	P80	PB273	100	400
69957348200	P100	PB273	100	400
69957348201	P120	PB273	100	400
69957348202	P150	PB273	100	400
69957348203	P180	PB273	100	400
69957348204	P220	PB273	100	400
69957348206	P320	PB273	100	400
69957348223	P600	PB273	100	400



PART #	GRADING		ROLLS/CASE	MIN. QTY.
6" x 0" LINK DISC ROLLS				
66623362940	P80	PB273	4	4
69957352447	P100	PB273	4	4
66623362939	P120	PB273	4	4
66623362938	P150	PB273	4	4
66623362937	P180	PB273	4	4
66623362936	P220	PB273	4	4
66623362935	P240	PB273	4	4
66623362934	P320	PB273	4	4
66623362933	P400	PB273	4	4
66623362932	P600	PB273	4	4
66623362931	P800	PB273	4	4

100 discs per roll. Order in multiples of 4 rolls.

SILICON CARBIDE STICK-ON DISCS

Better Tier / Silicon Carbide Dri-Lube Resin Paper Open

CARBO™



Machine sanding metal primer coats and between finish coats. Also for whitewood between wash, sealer, and lacquer coats.

FEATURES	BENEFITS
• P-graded, hard silicon carbide abrasive	• Sharp cut, excellent for finishing
• Full resin bond system	• Improved grain adhesion and longest disc life
• Flexible, B-weight latex paper	• Tear resistance and flexibility
• PSA backing	• Easy application and removal
• Water-based stearate anti-loading oversize and an open coat	• Improved load resistance
• Link disc roll	• Easy dispensing

PART #	GRADING		ROLLS/CASE	MIN. QTY.
5" x 0" LINK DISC ROLLS				
05539510526	P80	B 0412 DO	4	4
05539510525	P100	B 0412 DO	4	4
05539510523	P120	B 0412 DO	4	4
05539510522	P150	B 0412 DO	4	4
05539510521	P180	B 0412 DO	4	4
05539510517	P320	B 0412 DO	4	4
05539510516	P400	B 0412 DO	4	4

PART #	GRADING		ROLLS/CASE	MIN. QTY.
6" x 0" LINK DISC ROLLS				
05539510540	P180	B 0412 DO	4	4
05539510539	P220	B 0412 DO	4	4

150 grit and coarser: 125 discs per roll; 180 grit and finer: 250 discs per roll.



BACK-UP PADS FOR STICK-ON AND GLUE-ON DISCS

Accessory



Vinyl-faced pads for use with Stick-On discs or conventional discs using disc adhesive. 5" and 6" pads have a riveted 5/16"-24 threaded shank. 8" pads have a 5/8"-11 threaded female hub.

PART #	DESCRIPTION	MAX. RPM	PADS/CASE
BACK-UP PADS FOR STICK-ON AND GLUE-ON DISCS			
05539599304	5" Low Profile - Soft	12,000	5*
05539599309	5" Low Profile - Medium	15,000	5*
05539599317	5" Tapered - Medium	15,000	5*
05539599305	6" Low Profile - Soft	12,000	5*
05539599311	6" Low Profile - Medium	15,000	5*
05539599319	6" Tapered - Medium	15,000	5*
05539512023	8" x 1/2 Tapered - Medium	4,800	1

* Packaged in individual clamshells

PREMIER RED STICK-ON PAPER DISCS

Better Tier / Zirconia Alumina Resin Paper Open



Best choice for stripping paint and rust, as well as blending welds.

FEATURES	BENEFITS
• Premium zirconia alumina abrasive and an open coat	• Fast removal rates • Extended life
• Full, phenolic resin bond system plus latex	• Maximum durability plus flexibility • Excellent grain adhesion
• E-weight, latex paper backing	• Reduced edge shed • Greater flexibility
• PSA backing	• Easy application and removal

PART #	GRADING		DISCS/PKG.	DISCS/CASE
6" x 0" INDIVIDUAL DISCS				
05539521302	36 E 1214 O		50	200
05539521301	40 E 1214 O		50	200
05539521300	80 E 1214 O		50	200

PART #	GRADING		DISCS/PKG.	DISCS/CASE
8" x 0" INDIVIDUAL DISCS				
05539521305	36 E 1214 O		25	100
05539521304	40 E 1214 O		25	100
05539521303	80 E 1214 O		25	100

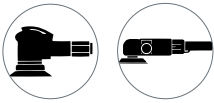

PREMIER RED STICK-ON PAPER DISCS

Better Tier / Aluminum Oxide Resin Paper Open



Ideally suited for weld blending, metal polishing and whitewood sanding, clean-up and repair.

FEATURES	BENEFITS
• Tough, P-graded, heat-treated, aluminum oxide abrasive	• Aggressive yet cool cut
• Full resin bond system	• Increased strength and durability
• High strength, F-weight paper backing	• Increased durability and reduced edge wear
• PSA backing	• Easy application and removal
• Link disc roll	• Easy dispensing

PART #	GRADING		ROLLS/CASE	MIN. QTY.
5" x 0" LINK DISC ROLLS				
05539512549	P60 F 0915		4	4
05539512550	P80 F 0915		4	4
05539512551	P100 F 0915		4	4

PART #	GRADING		ROLLS/CASE	MIN. QTY.
6" x 0" LINK DISC ROLLS				
05539512556	P60 F 0915		4	4
05539512557	P80 F 0915		4	4
100 discs per roll. Order in multiples of 4 rolls.				

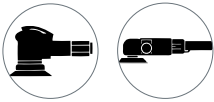

See disc roll dispenser for these discs on page 36.

PSA CONVERSION DISCS

Accessory



Permanent adhesive on textile hook backing allows for low cost conversion of Stick-On pads to Grip-On.

PART #	DESCRIPTION	PAD NUTS/CASE
STICK-ON TO GRIP-ON CONVERSION DISCS		
05539529418	6"	20



Best choice for sanding all paints, primers, plastics and fiberglass. Also suited for sealer and wash coats in wood furniture.

FEATURES	BENEFITS
<ul style="list-style-type: none"> • P-graded, heat-treated, aluminum oxide abrasive 	<ul style="list-style-type: none"> • 30% to 50% faster cut rate than other discs • Consistent scratch pattern and finish
<ul style="list-style-type: none"> • Full resin bond system 	<ul style="list-style-type: none"> • Improved grain adhesion and longest disc life
<ul style="list-style-type: none"> • Unique fiber-reinforced, B-weight, latex-saturated backing 	<ul style="list-style-type: none"> • 50% – 60% improvement in tear strength, superior resistance to delamination
<ul style="list-style-type: none"> • PSA (pressure sensitive adhesive) backing 	<ul style="list-style-type: none"> • Easy application and removal
<ul style="list-style-type: none"> • Special, undyed stearate oversize, and an open coat 	<ul style="list-style-type: none"> • Superior load resistance and extended life • No color transfer to work
<ul style="list-style-type: none"> • Vacuum holes 	<ul style="list-style-type: none"> • Dust-free sanding environment • Extended life
<ul style="list-style-type: none"> • Link disc roll, 4-pack with polybags 	<ul style="list-style-type: none"> • Easy dispensing • Minimizes storage space • Protects individual rolls

PART #	GRADING		ROLLS/CASE	MIN. QTY.
5" x 5 HOLE VACUUM LINK DISC ROLLS D-3329				
05539515295	P80	B 0912 DO	4	4
05539515294	P100	B 0912 DO	4	4
05539515293	P120	B 0912 DO	4	4
05539515292	P150	B 0912 DO	4	4
05539515291	P180	B 0912 DO	4	4
05539515287	P220	B 0912 DO	4	4
05539515286	P240	B 0912 DO	4	4
05539515284	P320	B 0912 DO	4	4
05539515282	P400	B 0912 DO	4	4

PART #	GRADING		ROLLS/CASE	MIN. QTY.
6" x 6 HOLE VACUUM LINK DISC ROLLS D-3333				
05539515317	P80	B 0912 DO	4	4
05539515316	P100	B 0912 DO	4	4
05539515315	P120	B 0912 DO	4	4
05539515313	P150	B 0912 DO	4	4
05539515312	P180	B 0912 DO	4	4
05539515311	P220	B 0912 DO	4	4
05539515304	P240	B 0912 DO	4	4
05539515300	P320	B 0912 DO	4	4
05539515298	P400	B 0912 DO	4	4
05539515297	P600	B 0912 DO	4	4

100 discs per roll. Order in multiples of 4 rolls.



See back-up pads and disc roll dispensers for these discs on page 36.

techtip

Die pattern numbers showing hole patterns on Vacuum Stick-On Discs.

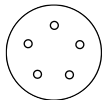

DIE D-3329 – DISC ROLLS
5" PAD WITH
5 VACUUM HOLES

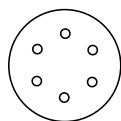

DIE D-3333 – DISC ROLLS
6" PAD WITH
6 VACUUM HOLES

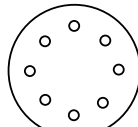

DIE D-3370
8" PAD WITH
8 VACUUM HOLES



CARBO GOLD VACUUM STICK-ON PAPER DISCS

Good Tier / Aluminum Oxide Dri-Lube Resin Paper Open



Ideal for sanding paints, primers, plastics and fiberglass, as well as whitewood sanding, clean-up and repair.

FEATURES	BENEFITS
• Premium, P-graded, light brown aluminum oxide abrasive	• Fast cut, long life
• Durable C-weight backing	• High tear resistance
• PSA (pressure sensitive adhesive) backing	• Easy application and removal
• Special, water-based stearate oversize, and an open coat	• Excellent load resistance
• Vacuum holes	• Dust-free sanding environment
• Link disc roll	• Easy dispensing
• 4-pack with polybags	• Minimizes storage space
	• Reduces cardboard waste
	• Protects individual rolls

PART #	GRADING		ROLLS/CASE	MIN. QTY.
5" x 5 HOLE VACUUM LINK DISC ROLLS D-3329				
05539563612	P80	C 0712 DO	4	4
05539563609	P180	C 0712 DO	4	4
100 discs per roll. Order in multiples of 4 rolls.				

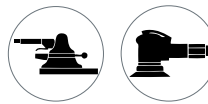

See back-up pads for these discs on next page. Disc roll dispenser available on next page.

PREMIER RED VACUUM STICK-ON PAPER DISCS

Better Tier / Zirconia Alumina Resin Paper Open



Best choice for stripping paint and rust, as well as blending welds.

FEATURES	BENEFITS
• Premium, zirconia alumina abrasive and an open coat	• Fast removal rates, extended life
• Full phenolic resin bond system plus latex	• Maximum durability plus flexibility
	• Excellent grain adhesion
• E-weight, latex paper backing	• Reduced edge shed
	• Greater flexibility
• PSA (pressure sensitive adhesive) backing	• Easy application and removal
• Vacuum holes	• Dust-free sanding environment

PART #	GRADING		DISCS/PKG.	DISCS/CASE
8" x 8 HOLE INDIVIDUAL VACUUM DISCS D-3370				
05539521311	36	E 1214 O	25	100
05539521309	80	E 1214 O	25	100



DISC ROLL DISPENSERS

Accessory



These convenient disc roll dispensers feature heavy-duty construction and a rubberized finish to protect your product. Designed to accommodate any 5" or 6" disc rolls or sheet rolls, they can be easily moved from one work station to another, attached to a wall, or stacked for multi-grit or multi-diameter operations. Discs are individually removed from the roll by a cutter bar.

PART #	DESCRIPTION	DISPENSERS/CASE
DISC ROLL DISPENSER		
05539520361	Disc Roll Dispenser – Single	1
05539520299	Disc Roll Dispenser – Double	1

BACK-UP PADS FOR VACUUM STICK-ON DISCS

Accessory



Vinyl-faced pads for use with Stick-On discs with standard vacuum hole patterns. These pads have a riveted 5/16"-24 threaded shank.

PART #	DESCRIPTION	MAX. RPM	PADS/CASE
BACK-UP PAD FOR STICK-ON VACUUM DISCS			
05539599310	5" x 5 Hole Low Profile - Medium	15,000	5
05539599318	5" x 5 Hole Tapered - Medium	15,000	5
05539599312	6" x 6 Hole Low Profile - Medium	15,000	5
05539599320	6" x 6 Hole Tapered - Medium	15,000	5

Packaged in individual clamshells

GRIP-ON PAPER DISC COMPETITIVE CROSS REFERENCE

CARBORUNDUM	3M	HERMES	KLINGSPOR	MIRKA	SIA	VSM
PAPER DISCS						
B 2312 DO, C 2312 DO	735U, 734U	–	PS36	–	1950 Siaspeed	–
B 0912 DO, B 0712 DO	216U, 255L, 260L, 334U	VC154-LL	PS73	Q-Silver, Royal	1950, 1940	MPG
C 0712 DO, PB273	236U, 316U, Red, NX	HCAB, HC135-LL, VC151-LL	PS33, PL36	BaseCut Bulldog Gold	– 1947	MP10 KP911
E 1214 O	750U, 751U, 740I, 745I	–	–	Royal Coarse Cut	–	KP510E, KP709

GRIP-ON PAPER DISC STARTING RECOMMENDATIONS BY MATERIAL/APPLICATION

MATERIAL	BEST PERFORMANCE	GENERAL-DUTY
Unfinished Metal	E 1214 O	E 0912 O
Primed and Painted Surfaces	C 2312 DO / B 2312 DO	C 0712 DO, PB273
Fiberglass / Composites	C 2312 DO / B 2312 DO, E 1214 O	C 0712 DO, PB273, E 0912 O
Bare Wood	C 2312 DO / B 2312 DO	C 0712 DO, PB273
Sealer Sanding	C 2312 DO / B 2312 DO	B 0412 DO
Paint Stripping	C 2312 DO / B 2312 DO, E 1214 O	C 0712 DO, PB273, E 0912 O



Best choice for stripping and preparing primed and painted surfaces for finishing, sanding of plastics, fiberglass, and composites, bare wood sanding, light weld blending, preparing and finishing metal, and sanding of all gel coats and body filler compounds.

FEATURES	BENEFITS
<ul style="list-style-type: none"> Ceramic alumina abrasive, P80 - P1500 grit range 	<ul style="list-style-type: none"> Fastest cut rate even on hard-to-sand surfaces Extended life – up to 2:1 over conventional discs Broadest ceramic grit range available
<ul style="list-style-type: none"> Full resin bond system 	<ul style="list-style-type: none"> Improved grain adhesion and longest disc life
<ul style="list-style-type: none"> Unique fiber-reinforced, flexible B- and C-weight latex-saturated backing 	<ul style="list-style-type: none"> 50% - 60% improvement in tear resistance, superior resistance to delamination Durable, yet flexible
<ul style="list-style-type: none"> Special undyed stearate oversize 	<ul style="list-style-type: none"> Superior load resistance and extended life No color transfer to work
<ul style="list-style-type: none"> Hook and loop fastening system 	<ul style="list-style-type: none"> Neat, clean application and removal Can be re-used

PART #	GRADING		DISCS/PKG.	DISCS/CASE
3" x 0" INDIVIDUAL DISCS				
05539553334	P80	C 2312 DO	50	200
05539553335	P120	C 2312 DO	50	200
05539553336	P150	B 2312 DO	50	200
05539553337	P180	B 2312 DO	50	200
05539553338	P220	B 2312 DO	50	200
05539553339	P320	B 2312 DO	50	200
05539553340	P400	B 2312 DO	50	200
05539553341	P600	B 2312 DO	50	200
05539553342	P800	B 2312 DO	50	200
05539553343	P1000	B 2312 DO	50	200
05539553344	P1500	B 2312 DO	50	200
5" x 0" INDIVIDUAL DISCS				
05539599513	P80	C 2312 DO	50	200
05539599512	P100	C 2312 DO	50	200
05539599511	P120	C 2312 DO	50	200
05539599510	P150	B 2312 DO	50	200
05539599509	P180	B 2312 DO	50	200
05539599508	P220	B 2312 DO	50	200
05539599507	P240	B 2312 DO	50	200
05539599506	P280	B 2312 DO	50	200
05539599505	P320	B 2312 DO	50	200
05539599504	P400	B 2312 DO	50	200
05539599503	P500	B 2312 DO	50	200
05539599502	P600	B 2312 DO	50	200
05539599501	P800	B 2312 DO	50	200

PART #	GRADING		DISCS/PKG.	DISCS/CASE
6" x 0" INDIVIDUAL DISCS				
05539599526	P80	C 2312 DO	50	200
05539599525	P100	C 2312 DO	50	200
05539599524	P120	C 2312 DO	50	200
05539599523	P150	B 2312 DO	50	200
05539599522	P180	B 2312 DO	50	200
05539599521	P220	B 2312 DO	50	200
05539599520	P240	B 2312 DO	50	200
05539599519	P280	B 2312 DO	50	200
05539599518	P320	B 2312 DO	50	200
05539599517	P400	B 2312 DO	50	200
05539599516	P500	B 2312 DO	50	200
05539599515	P600	B 2312 DO	50	200
05539599514	P800	B 2312 DO	50	200
05539599423	P1000	B 2312 DO	50	200
05539599444	P1500	B 2312 DO	50	200

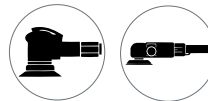

See back-up pads for these discs on page 41.



Best choice for sanding all paints, primers, plastics and fiberglass. Also suited for sealer and wash coats in wood furniture.

FEATURES	BENEFITS
<ul style="list-style-type: none"> • P-graded, heat-treated, aluminum oxide abrasive 	<ul style="list-style-type: none"> • 30% to 50% faster cut rate than other discs • Consistent scratch pattern and finish
<ul style="list-style-type: none"> • Full resin bond system 	<ul style="list-style-type: none"> • Improved grain adhesion and longest disc life
<ul style="list-style-type: none"> • Unique fiber-reinforced, B-weight, latex-saturated backing 	<ul style="list-style-type: none"> • 50% – 60% improvement in tear strength, superior resistance to delamination
<ul style="list-style-type: none"> • Hook and loop fastening system 	<ul style="list-style-type: none"> • Neat, clean application and removal • Can be re-used
<ul style="list-style-type: none"> • Special, undyed stearate oversize and an open coat 	<ul style="list-style-type: none"> • Superior load resistance and extended life • No color transfer to work

PART #	GRADING		DISCS/PKG.	DISCS/CASE
3" x 0" INDIVIDUAL DISCS				
05539570019	P80	B 0912 DO	50	200
05539599427	P120	B 0912 DO	50	200
05539570020	P180	B 0912 DO	50	200
05539570021	P320	B 0912 DO	50	200
05539570022	P800	B 0712 DO	50	200
05539569926	P1000	B 0712 DO	50	200
05539569927	P1500	B 0712 DO	50	200
5" x 0" INDIVIDUAL DISCS				
05539520269	P80	B 0912 DO	100	400
05539520267	P100	B 0912 DO	100	400
05539520266	P120	B 0912 DO	100	400
05539520264	P150	B 0912 DO	100	400
05539520263	P180	B 0912 DO	100	400
05539520262	P220	B 0912 DO	100	400
05539520260	P240	B 0912 DO	100	400
05539520259	P280	B 0912 DO	100	400
05539520258	P320	B 0912 DO	100	400
05539520257	P400	B 0912 DO	100	400
05539563781	P500	B 0912 DO	100	400
05539520256	P600	B 0912 DO	100	400
05539520255	P800	B 0712 DO	100	400
05539520254	P1000	B 0712 DO	100	400
05539520253	P1200	B 0712 DO	100	400
05539520252	P1500	B 0712 DO	100	400

PART #	GRADING		DISCS/PKG.	DISCS/CASE
6" x 0" INDIVIDUAL DISCS				
05539520289	P80	B 0912 DO	100	400
05539520288	P100	B 0912 DO	100	400
05539520287	P120	B 0912 DO	100	400
05539520285	P150	B 0912 DO	100	400
05539520284	P180	B 0912 DO	100	400
05539520283	P220	B 0912 DO	100	400
05539520282	P240	B 0912 DO	100	400
05539520278	P280	B 0912 DO	100	400
05539520277	P320	B 0912 DO	100	400
05539520276	P400	B 0912 DO	100	400
05539563782	P500	B 0912 DO	100	400
05539520275	P600	B 0912 DO	100	400
05539520274	P800	B 0712 DO	100	400
05539520272	P1000	B 0712 DO	100	400
05539520271	P1200	B 0712 DO	100	400
05539520270	P1500	B 0712 DO	100	400

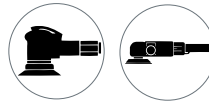

See back-up pads for these discs on page 41.

CARBO GOLD GRIP-ON PAPER DISCS
Good Tier / Aluminum Oxide Dri-Lube Resin Paper Open



Ideal for sanding paints, primers, plastics and fiberglass, as well as whitewood sanding, clean-up and repair.

FEATURES	BENEFITS
• P-graded, light brown, aluminum oxide abrasive	• Fast cut, long life
• Full resin bond system	• Improved grain adhesion and longest disc life
• C-weight backing	• Durable, high tear resistance
• Hook and loop fastening system	• Neat, clean application and removal
• Special, water-based stearate oversize and an open coat	• Excellent load resistance

PART #	GRADING	DISCS/PKG.	DISCS/CASE
5" x 0" INDIVIDUAL DISCS			
05539520123	P80 C 0712 DO	100	400
05539520122	P100 C 0712 DO	100	400
05539520121	P120 C 0712 DO	100	400
05539520120	P150 C 0712 DO	100	400
05539520119	P180 C 0712 DO	100	400
05539520118	P220 C 0712 DO	100	400
05539520115	P320 C 0712 DO	100	400

PART #	GRADING	DISCS/PKG.	DISCS/CASE
6" x 0" INDIVIDUAL DISCS			
05539520134	P80 C 0712 DO	100	400
05539520133	P100 C 0712 DO	100	400
05539520132	P120 C 0712 DO	100	400
05539520131	P150 C 0712 DO	100	400
05539520130	P180 C 0712 DO	100	400
05539520129	P220 C 0712 DO	100	400
05539520126	P320 C 0712 DO	100	400
05539520125	P400 C 0712 DO	100	400

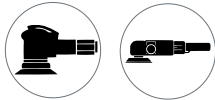

MERIT PB273 GRIP-ON PAPER DISCS
Good Tier / Aluminum Oxide Dri-Lube Resin Paper Open

PB273



Good choice for sanding paint, primer, plastics, and fiberglass, as well as whitewood sanding, clean-up, and repair – at a low initial price.

FEATURES	BENEFITS
• P-graded, sharp, light-brown aluminum oxide abrasive	• Fast cut rate, extended life, and consistent finish
• Full resin bond system	• Improved grain adhesion and longest disc life
• Premium B-weight latex-saturated, high-internal-bond paper backing	• Improved resistance to delamination
• Water-based stearate anti-loading oversize and an open coat	• Improved load resistance on a broad range of substrates
• No pigment in anti-load oversize or bond	• No risk of color transfer, stronger bond
• Hook and loop fastening system	• Neat, clean application and removal

PART #	GRADING	DISCS/PKG.	DISCS/CASE
5" x 0" INDIVIDUAL DISCS			
66623362950	P80 PB273	100	400
66623365788	P100 PB273	100	400
66623362949	P120 PB273	100	400
66623362948	P150 PB273	100	400
66623362947	P180 PB273	100	400
66623362946	P220 PB273	100	400
66623362945	P240 PB273	100	400
66623362944	P320 PB273	100	400
66623362943	P400 PB273	100	400
66623362942	P600 PB273	100	400
66623362941	P800 PB273	100	400

PART #	GRADING	DISCS/PKG.	DISCS/CASE
6" x 0" INDIVIDUAL DISCS			
66623362960	P80 PB273	100	400
66623365789	P100 PB273	100	400
66623362959	P120 PB273	100	400
66623362958	P150 PB273	100	400
66623362957	P180 PB273	100	400
66623362956	P220 PB273	100	400
66623362955	P240 PB273	100	400
66623362954	P320 PB273	100	400
66623362953	P400 PB273	100	400
66623362952	P600 PB273	100	400
66623362951	P800 PB273	100	400

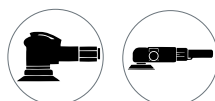



Best choice for stripping paint and rust, as well as blending welds.

FEATURES	BENEFITS
<ul style="list-style-type: none"> Premium zirconia alumina abrasive and an open coat 	<ul style="list-style-type: none"> Fast removal rates Extended life
<ul style="list-style-type: none"> Full phenolic resin bond system plus latex 	<ul style="list-style-type: none"> Maximum durability plus flexibility Excellent grain adhesion
<ul style="list-style-type: none"> E-weight latex paper backing 	<ul style="list-style-type: none"> Reduced edge shed Greater flexibility
<ul style="list-style-type: none"> Hook and loop fastening system 	<ul style="list-style-type: none"> Neat, clean application and removal Can be re-used

PART #	GRADING		DISCS/PKG.	DISCS/CASE
6" x 0" INDIVIDUAL DISCS				
05539521316	40	E 1214 O	25	100
05539521315	80	E 1214 O	25	100

PART #	GRADING		DISCS/PKG.	DISCS/CASE
8" x 0" INDIVIDUAL DISCS				
05539521320	36	E 1214 O	25	100
05539521319	40	E 1214 O	25	100
05539521318	80	E 1214 O	25	100

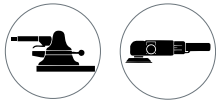

BACK-UP PADS FOR GRIP-ON DISCS

Accessory



Back-up pads for use with Grip-On discs. Incorporate unique hook and loop fastening system for neat, clean application and removal. 5" and 6" pads have a riveted 5/16"-24 threaded shank. 8" pads have a 5/8-11 threaded female hub.

PART #	DESCRIPTION	MAX. RPM	PADS/CASE
05539599306	3" Low Profile - Soft	12,000	10*
05539599307	5" Low Profile - Soft	12,000	5*
05539599313	5" Low Profile - Medium	15,000	5*
05539599321	5" Tapered - Medium	15,000	5*
05539599308	6" Low Profile - Soft	12,000	5*
05539599315	6" Low Profile - Medium	15,000	5*
05539599323	6" Tapered - Medium	15,000	5*
05539512030	8" Tapered - Medium	4,800	1

* Packaged in Individual Clamshells

INTERFACE PADS FOR GRIP-ON DISCS

Accessory



Soft, pliable foam pad which fastens to the standard 5" and 6" Grip-On back-up pad using a hook and loop system. It converts the standard pad into a fine finishing pad and enhances P1000, P1200, and P1500 grit fine sanding random orbital applications.

PART #	DESCRIPTION	PADS/CASE
05539520521	5" Interface Pad	20
05539520520	6" Interface Pad	20

PREMIER RED VACUUM GRIP-ON PAPER DISCS

Better Tier / Aluminum Oxide Dri-Lube Resin Paper Open



Best choice for sanding all paints, primers, plastics and fiberglass. Also suited for sealer and wash coats in wood furniture.

FEATURES	BENEFITS
<ul style="list-style-type: none"> • P-graded, heat-treated, aluminum oxide abrasive 	<ul style="list-style-type: none"> • 30% to 50% faster cut rate than other discs • Consistent scratch pattern and finish
<ul style="list-style-type: none"> • Full resin bond system 	<ul style="list-style-type: none"> • Improved grain adhesion and longest disc life
<ul style="list-style-type: none"> • Unique fiber-reinforced, B-weight, latex-saturated backing 	<ul style="list-style-type: none"> • 50% – 60% improvement in tear strength, superior resistance to delamination
<ul style="list-style-type: none"> • Hook and loop fastening system 	<ul style="list-style-type: none"> • Neat, clean application and removal • Can be re-used
<ul style="list-style-type: none"> • Special, undyed stearate oversize and an open coat 	<ul style="list-style-type: none"> • Superior load resistance and extended life • No color transfer to work
<ul style="list-style-type: none"> • Vacuum holes 	<ul style="list-style-type: none"> • Dust-free sanding environment • Extended life

PART #	GRADING		DISCS/PKG.	DISCS/CASE
5" x 5 HOLE INDIVIDUAL VACUUM DISCS D-3328				
05539520315	P80	B 0912 DO	100	400
05539520314	P100	B 0912 DO	100	400
05539520313	P120	B 0912 DO	100	400
05539520312	P150	B 0912 DO	100	400
05539520311	P180	B 0912 DO	100	400
05539520310	P220	B 0912 DO	100	400
05539520307	P320	B 0912 DO	100	400
05539520306	P400	B 0912 DO	100	400
05539520305	P600	B 0912 DO	100	400

PART #	GRADING		DISCS/PKG.	DISCS/CASE
6" x 6 HOLE INDIVIDUAL VACUUM DISCS D-3371				
05539520331	P80	B 0912 DO	100	400
05539520330	P100	B 0912 DO	100	400
05539520329	P120	B 0912 DO	100	400
05539520328	P150	B 0912 DO	100	400
05539520326	P180	B 0912 DO	100	400
05539520325	P220	B 0912 DO	100	400
05539520324	P240	B 0912 DO	100	400
05539520323	P280	B 0912 DO	100	400
05539520322	P320	B 0912 DO	100	400
05539520321	P400	B 0912 DO	100	400
05539563784	P500	B 0912 DO	100	400
05539520320	P600	B 0912 DO	100	400
05539520319	P800	B 0712 DO	100	400
05539520318	P1000	B 0712 DO	100	400



See back-up pads for these discs on page 44.

techtip

Die pattern numbers showing hole patterns on Vacuum Grip-On Discs.

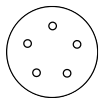

DIE D-3328
5" PAD WITH
5 VACUUM HOLES

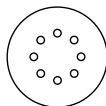

DIE D-3392
5" PAD WITH
8 VACUUM HOLES

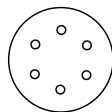

DIE D-3371
6" PAD WITH
6 VACUUM HOLES

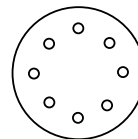

DIE D-3370
8" PAD WITH
8 VACUUM HOLES



CARBO GOLD VACUUM GRIP-ON PAPER DISCS

Good Tier / Aluminum Oxide Dri-Lube Resin Paper Open



Ideal for sanding paints, primers, plastics and fiberglass, as well as whitewood sanding, clean-up, and repair.

FEATURES	BENEFITS
• P-graded, light brown, aluminum oxide abrasive	• Fast cut, long life
• Full resin bond system	• Improved grain adhesion and longest disc life
• C-weight backing	• Durable, high tear resistance
• Hook and loop fastening system	• Neat, clean application and removal
• Special, water-based stearate oversize and an open coat	• Excellent load resistance
• Vacuum holes	• Dust-free sanding environment

PART #	GRADING	DISCS/PKG.	DISCS/CASE
5" x 5 HOLE INDIVIDUAL VACUUM DISCS D-3328			
05539563628	P80 C 0712 DO	50	200
05539563627	P120 C 0712 DO	50	200
05539563624	P220 C 0712 DO	50	200



See back-up pads for these discs on page 44

MERIT PB273 VACUUM GRIP-ON PAPER DISCS

Good Tier / Aluminum Oxide Dri-Lube Resin Paper Open



Good choice for sanding paint, primer, plastics, and fiberglass, as well as whitewood sanding, clean-up, and repair – at a low initial price.

FEATURES	BENEFITS
• P-graded, sharp, light-brown aluminum oxide abrasive	• Fast cut rate, extended life, and consistent finish
• Full resin bond system	• Improved grain adhesion and longest disc life
• Premium B-weight latex-saturated, high-internal-bond paper backing	• Improved resistance to delamination
• Water-based stearate anti-loading oversize and an open coat	• Improved load resistance on a broad range of substrates
• No pigment in anti-load oversize or bond	• No risk of color transfer, stronger bond
• Hook and loop fastening system	• Neat, clean application and removal
• Vacuum holes	• Dust-free sanding environment

PART #	GRADING	ROLLS/CASE	MIN. QTY.
5" x 8 HOLE INDIVIDUAL VACUUM DISCS D-3392			
66623366071	P80 PB273	100	400
66623369778	P120 PB273	100	400
66623366073	P150 PB273	100	400
66623366074	P180 PB273	100	400
66623366075	P220 PB273	100	400
66623366077	P320 PB273	100	400



See back-up pads for these discs on page 44.

PREMIER RED VACUUM GRIP-ON PAPER DISCS

Better Tier / Zirconia Alumina Resin Paper Open



Best choice for stripping paint and rust, as well as blending welds.

FEATURES	BENEFITS
<ul style="list-style-type: none"> Premium zirconia alumina abrasive 	<ul style="list-style-type: none"> Faster removal rates than aluminum oxide discs Extended life
<ul style="list-style-type: none"> Full phenolic resin bond system plus latex 	<ul style="list-style-type: none"> Maximum durability plus flexibility Excellent grain adhesion
<ul style="list-style-type: none"> E-weight latex paper backing 	<ul style="list-style-type: none"> Reduced edge shed Greater flexibility
<ul style="list-style-type: none"> Hook and loop fastening system 	<ul style="list-style-type: none"> Neat, clean application and removal
<ul style="list-style-type: none"> Vacuum holes 	<ul style="list-style-type: none"> Dust-free sanding environment

PART #	GRADING		DISCS/PKG.	DISCS/CASE
8" x 8 HOLE INDIVIDUAL VACUUM DISCS D-3370				
05539521325	40	E 1214 O	25	100
05539521324	80	E 1214 O	25	100



BACK-UP PADS FOR VACUUM GRIP-ON DISCS

Accessory



Unique hook and loop fastening system for use with standard 5" and 6" vacuum hole patterns. These pads have a riveted 5/16"-24 threaded shank.

PART #	DESCRIPTION	MAX. RPM	PADS/CASE
BACK-UP PADS FOR GRIP-ON VACUUM DISCS			
05539599314	5" x 5 Hole Low Profile - Medium	15,000	5*
05539599322	5" x 5 Hole Tapered - Medium	15,000	5*
05539599316	6" x 6 Hole Low Profile - Medium	15,000	5*
05539599324	6" x 6 Hole Tapered - Medium	15,000	5*

* Packaged in Individual Clamshells

CARBO CLEANAIR PLUS MEDALIST VACUUM GRIP-ON PAPER DISCS

Best Tier / Ceramic Alumina Dri-Lube Resin Paper Open



Combine the revolutionary maximum dust extraction Carbo CleanAir Plus back-up pad with Carbo CleanAir Plus Medalist Dri-Lube discs to optimize performance, increase productivity and eliminate dust. Perform well on conventional paints and primers, wood, as well as hard-to-sand surfaces like ceramic clears, E-coated panels, aluminum and composites.

FEATURES	BENEFITS
<ul style="list-style-type: none"> Precision laser-cut, spiral-hole design 	<ul style="list-style-type: none"> 42% more effective at targeting dust than the original CleanAir design No clogging; allows for maximum dust extraction Virtually dust-free sanding for a cleaner work environment Less potential for contamination Consistent cut throughout the life of the disc Deliver more productivity with fewer disc changes
<ul style="list-style-type: none"> Ceramic alumina grain 	<ul style="list-style-type: none"> Quick/cool superior cut on difficult-to-sand surfaces Substantially longer life and faster cut than conventional abrasives
<ul style="list-style-type: none"> Unique fiber-reinforced latex/paper backing 	<ul style="list-style-type: none"> Flexible, strong, and tear resistant
<ul style="list-style-type: none"> Water-based stearate coating (Dri-Lube) 	<ul style="list-style-type: none"> Load resistant for extended product life
<ul style="list-style-type: none"> Hook and loop fastening system 	<ul style="list-style-type: none"> Neat, clean, application and removal

PART #	GRADING		DISCS/PKG.	DISCS/CASE
6" x 11/16" INDIVIDUAL CARBO CLEANAIR PLUS VACUUM DISCS				
05539550000	P80	C 2312 DO	50	200
05539550001	P120	C 2312 DO	50	200
05539550002	P150	B 2312 DO	50	200
05539550003	P180	B 2312 DO	50	200
05539550004	P220	B 2312 DO	50	200
05539550005	P240	B 2312 DO	50	200
05539550006	P320	B 2312 DO	50	200
05539550007	P400	B 2312 DO	50	200

PART #	GRADING		DISCS/PKG.	DISCS/CASE
6" x 11/16" INDIVIDUAL CARBO CLEANAIR PLUS VACUUM DISCS				
05539550008	P500	B 2312 DO	50	200
05539550009	P600	B 2312 DO	50	200
05539550010	P800	B 2312 DO	50	200

Note: Must use multi-hole (54+) back-up pad. Use of the Carbo CleanAir Plus pad is recommended for optimal results.



BACK-UP PADS FOR CARBO CLEANAIR PLUS DISCS

Accessory

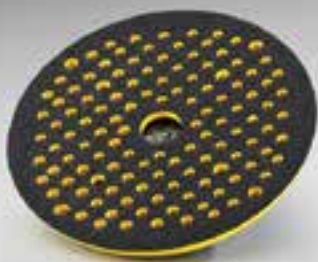

Clean Air Plus discs attach to any multi-hole (54+ holes) back up pad because the holes in the disc do not have to be matched up with the holes in the pad, so changeover is fast and easy. However, use of the Carbo CleanAir Plus pad is recommended for optimal results. This medium pad is engineered with durable urethane foam, heat-resistant plastic, a molded-in 5/16"-24 spindle, and hooked face.

PART #	DESCRIPTION	MAX. RPM	PADS/CASE
BACK-UP PADS FOR CARBO CLEANAIR DISCS			
63642506160	6" Medium	12,000	1

Less Dust Means More Productivity

The upgrade to precise, flat, laser-cut instead of die-punched holes, dramatically increases surface area contact allowing CleanAir Plus discs to improve productivity by 32% versus conventional multi-hole sanding and by 60% versus non-vacuum sanding.

The end result is more holes for dust extraction, more abrasive coverage for a better cut and no deformation for full surface contact utilizing all the cutting power of the premium ceramic grain.

CleanAir Plus laser-cut discs are flat and true.

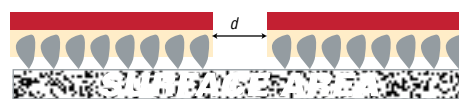

Conventional die-punched holes cause deformation.

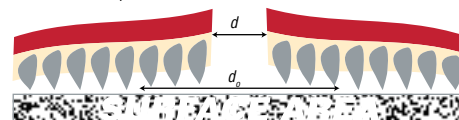

PREMIER RED GLUE-ON PAPER DISCS

Better Tier / Zirconia Alumina Resin Paper Open



Best choice for stripping paint and rust, as well as blending welds. Use disc cement to apply these discs.

FEATURES

- Premium zirconia alumina abrasive
- Full phenolic resin bond system plus latex
- E-weight, latex paper backing

BENEFITS

- Faster removal rates than aluminum oxide discs
- Extended life
- Maximum durability plus flexibility
- Excellent grain adhesion
- Reduced edge shed
- Greater flexibility

PART #	GRADING		DISCS/PKG.	DISCS/CASE
8" x 0" INDIVIDUAL DISCS				
05539521335	36	E 1214 0	25	100
05539521334	40	E 1214 0	25	100
05539521333	80	E 1214 0	25	100

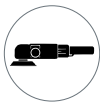

See back-up pads for these discs on page 32.





DISC COMPETITIVE CROSS REFERENCE

CARBORUNDUM	3M	HERMES	KLINGSPOR	MIRKA	VSM
CLOTH DISCS					
XC 0877	241D, 251D, 261D, 248D	RB346MX	CS310X	-	KK511X

MERIT SHURSTIK SMALL DIAMETER STICK-ON CLOTH DISCS



Good Tier / Aluminum Oxide Resin Cloth



Merit ShurStik PSA (pressure sensitive adhesive) individual cloth discs are used on pneumatic die grinders for light to medium pressure grinding, blending, beveling and finishing applications.

FEATURES	BENEFITS
<ul style="list-style-type: none"> Premium aluminum oxide abrasive Heavy, durable X-weight cotton backing 	<ul style="list-style-type: none"> Long life Ideal for aggressive stock removal applications Resistant to heat

PART #	GRADING	DISCS/CASE	PART #	GRADING	DISCS/CASE	PART #	GRADING	DISCS/CASE	PART #	GRADING	DISCS/CASE		
1/2"			1"			2"			4"				
08834171100	36	100	08834171129	36	100	08834171159	36	100	08834171188	24	100		
08834171101	40	100	08834171130	40	100	08834171160	40	100	08834171189	36	100		
08834171102	50	100	08834171131	50	100	08834171161	50	100	08834171190	40	100		
08834171103	60	100	08834171132	60	100	08834171162	60	100	08834171191	50	100		
08834171104	80	100	08834171133	80	100	08834171163	80	100	08834171192	60	100		
08834171105	100	100	08834171134	100	100	08834171164	100	100	08834171193	80	100		
08834171106	120	100	08834171135	120	100	08834171165	120	100	08834171194	100	100		
08834171107	150	100	08834171136	150	100	08834171166	150	100	08834171195	120	100		
08834171108	180	100	08834171137	180	100	08834171167	180	100	08834171196	150	100		
08834171109	240	100	08834171138	240	100	08834171168	240	100	08834171197	180	100		
08834171110	320	100	08834171139	320	100	08834171169	320	100	08834171198	240	100		
3/4"			1-1/2"			3"			08834171199			320	100
08834171114	36	100	08834171144	36	100	08834171173	24	100	 <p>See back-up pads for these discs on next page.</p>				
08834171115	40	100	08834171145	40	100	08834171174	36	100					
08834171116	50	100	08834171146	50	100	08834171175	40	100					
08834171117	60	100	08834171147	60	100	08834171176	50	100					
08834171118	80	100	08834171148	80	100	08834171177	60	100					
08834171119	100	100	08834171149	100	100	08834171178	80	100					
08834171120	120	100	08834171150	120	100	08834171179	100	100					
08834171121	150	100	08834171151	150	100	08834171180	120	100					
08834171122	180	100	08834171152	180	100	08834171181	150	100					
08834171123	240	100	08834171153	240	100	08834171182	180	100					
08834171124	320	100	08834171154	320	100	08834171184	320	100					

ALUMINUM OXIDE STICK-ON CLOTH DISCS

Good Tier / Aluminum Oxide Resin Cloth

CARBO™



Designed for intermediate/light pressure, dry sanding. Ideal for dimensioning and finishing of contours on metal and all species of wood.

FEATURES	BENEFITS
• Aluminum oxide abrasive	• Tough and durable with aggressive cutting action
• Full resin bond system	• Increased strength and durability
• X-weight cotton backing	• Cool operating
• PSA (pressure sensitive adhesive) backing	• Easy application and removal
• White paper liner	• Easy removal and disc application
	• The Stick-On adhesive is protected from air-borne contaminants

PART #	GRADING		DISCS/PKG.	DISCS/CASE
5" x 0" INDIVIDUAL DISCS				
05539520765	36	XC 0877	50	50
05539520766	50	XC 0877	50	50
05539520767	80	XC 0877	50	50

PART #	GRADING		DISCS/PKG.	DISCS/CASE
6" x 0" INDIVIDUAL DISCS				
05539520769	60	XC 0877	50	50
05539520770	80	XC 0877	50	50

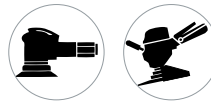

BACK-UP PADS FOR STICK-ON AND GLUE-ON DISCS

Accessory



Vinyl-faced pads for use with Stick-On discs or conventional discs using disc adhesive. 5" and 6" pads have a riveted 5/16"-24 threaded shank. 8" pads have a 5/8"-11 threaded female hub.

PART #	DESCRIPTION	MAX. RPM	PADS/CASE
BACK-UP PADS FOR STICK-ON DISCS			
05539599304	5" Low Profile - Soft	12,000	5*
05539599309	5" Low Profile - Medium	15,000	5*
05539599317	5" Tapered - Medium	15,000	5*
05539599305	6" Low Profile - Soft	12,000	5*
05539599311	6" Low Profile - Medium	15,000	5*
05539599319	6" Tapered - Medium	15,000	5*
05539512023	8" x 1/2 Tapered - Medium	4,800	1

* Packaged in individual clamshells

PSA CONVERSION DISCS

Accessory



Permanent adhesive on textile hook backing allows for low cost conversion of Stick-On pads to Grip-On.

PART #	DESCRIPTION	PADS/CASE
STICK-ON TO GRIP-ON CONVERSION DISC PADS		
05539529418	6"	20

BACK-UP PADS FOR CLOTH DISCS

Accessory

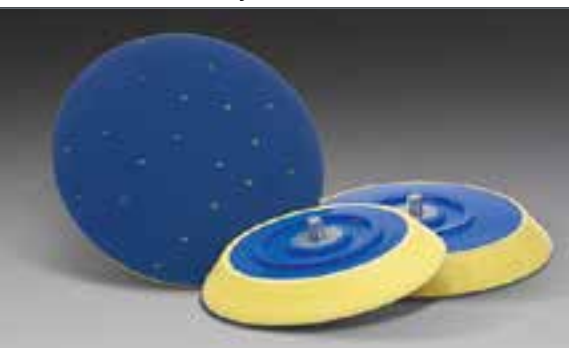

The backing of these small, air right-angle grinder, spindle-mounted back-up pads is designed to easily and securely mount and remove PSA-backed discs.

PART #	RPM	PADS/CASE	PART #	RPM	PADS/CASE
1/2"			2"		
08834174096	15,000	1	08834174100	12,000	1
3/4"			3"		
08834174097	15,000	1	08834174101	10,000	1
1"			4"		
08834174098	15,000	1	08834174102	6,000	1
1-1/2"					
08834174099	15,000	1			



COATED ABRASIVE QUICK-CHANGE DISC AVAILABILITY



Cloth 2-Ply

- Our standard 2-ply laminate construction creates an aggressive and durable cloth disc for flat surfaces

QUICK-CHANGE ATTACHMENT SYSTEMS AND CROSS REFERENCE GUIDE

Type TS (Type II)

- Features a turn-on/turn-off style fastener
- Fastener is made of metal
- Equivalent to Standard Abrasives' SocAtt® locking system



Type TR (Type III)

- Features a roll-on/roll-off style fastener
- Fastener is made of plastic
- Equivalent to 3M™ Roloc™ fastening system



Type TP (Type I)

- Snap-on/snap-off system which enables you to change discs quickly and safely, reducing downtime and operating expenses
- Fastener is made of nylon



CARBORUNDUM / MERIT	TS TYPE II	TR TYPE III	TP TYPE I
3M	Roloc TS/TSM	Roloc TR	Roloc TP
Standard	TS (SocAtt)	TR (Lockit)	TP (ClickOn)
Superior	Type S	Type R	–
Arc	Type S	Type R	Type P
Pferd	Type CD	Type CDR	–
Sait	SAIT-LOK	SAIT-LOK-R	–
Camel	Turn On	Roll On	–
Klingspor	QMC	QRC	–
Garryson	Type S	Type R	–

CROSS REFERENCE GUIDE



	BETTER	GOOD
Abrasive	Zirconia Alumina	Aluminum Oxide
Backing	Cloth	Cloth
Carborundum	Premier Red YP 1288	
Merit		ALO
3M	–	361F
Arc	Zirconia/Y Plus	A/O/Y Premium
Camel	Zirconia AO w/ Grinding Aid	Aluminum Oxide
Garryson	Zirconia AO w/ Grinding Aid	Aluminum Oxide
Klingspor	Alumina Zirconia - Lubricated	Aluminum Oxide
Pferd	–	Aluminum Oxide A, A/O A-FORTE
Sait	3Z, Z-H	2A-H, 2A
Standard	Zirconia Pro	A/O
Superior	Zirc w/ Grinding Aid	Premium A/O, Rigid Kut A/O
Weiler	Tiger Zirconia	Votec

APPLICATION/GRIT RECOMMENDATION GUIDE

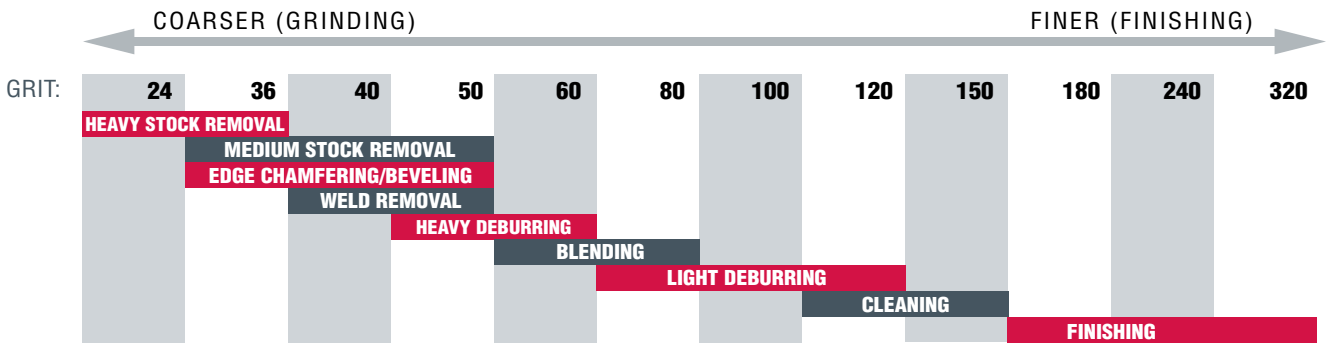



Strong zirconia alumina abrasive on Y-weight polyester backing with grinding aid results in cooler cut on stainless steel and other harder-to-grind materials.

FEATURES	BENEFITS
<ul style="list-style-type: none"> • Self sharpening zirconia alumina abrasive • Strong Y-weight 2-ply polyester backing 	<ul style="list-style-type: none"> • Cooler cut, longer life • Excellent durability and grain adhesion
<ul style="list-style-type: none"> • Grinding aid 	<ul style="list-style-type: none"> • Cooler cut on stainless steel, titanium and other exotic alloys

PART #	GRADING		STD. PKG.
TS (TYPE II)			
1-1/2"			
66623318721	36	YP 1288	100
66623318722	40	YP 1288	100
66623318724	60	YP 1288	100
66623318725	80	YP 1288	100
2"			
66623318743	24	YP 1288	100
66623318744	36	YP 1288	100
66623318745	40	YP 1288	100
66623318746	50	YP 1288	100
66623318747	60	YP 1288	100
3"			
66623318833	36	YP 1288	50
66623318834	40	YP 1288	50
66623318836	50	YP 1288	50
66623318839	60	YP 1288	50
66623318841	80	YP 1288	50
TR (TYPE III)			
2"			
66623318737	24	YP 1288	100
66623318738	36	YP 1288	100
66623318740	50	YP 1288	100
66623318741	60	YP 1288	100
66623318742	80	YP 1288	100
3"			
66623318842	24	YP 1288	50
66623318843	36	YP 1288	50
66623318846	60	YP 1288	50
66623318847	80	YP 1288	50

PART #	GRADING		STD. PKG.
TP (TYPE I)			
1-1/2"			
66623318718	50	YP 1288	100
66623318719	60	YP 1288	100
66623318720	80	YP 1288	100
2"			
66623318731	24	YP 1288	100
66623318733	40	YP 1288	100
66623318734	50	YP 1288	100
66623318735	60	YP 1288	100
66623318736	80	YP 1288	100
3"			
66623318824	36	YP 1288	50
66623318825	40	YP 1288	50
66623318826	50	YP 1288	50
66623318830	60	YP 1288	50
66623318831	80	YP 1288	50

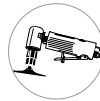

See back-up pads and accessories for these discs on pages 55-56.

techtip

Avoid gouging on contours by using a smaller size back-up pad than the diameter of the discs, such as 1-1/2" back-up pad for 2" discs. For 3" discs and larger, order the special FlexEdge back-up pad part # 08834168539 that is 2" in diameter but contains the cam lock fastener for 3" and larger discs.



Premium abrasive and aluminum oxide blend for aggressive cut and longer life than competitive aluminum oxide discs. Durable Y-weight. 2-ply polyester backing and special grain coating for longer life and faster cut rate on moderately-demanding applications. Great for difficult-to-grind materials (aluminum, brass, bronze, stainless, carbon steel, and titanium) and applications requiring an economical option.

FEATURES	BENEFITS
<ul style="list-style-type: none"> Premium abrasive and aluminum oxide blend 	<ul style="list-style-type: none"> Aggressive cut and longer life than competitive aluminum oxide discs
<ul style="list-style-type: none"> Durable Y-weight 2-ply polyester backing and special grain coating 	<ul style="list-style-type: none"> Longer life and faster cut rate on moderately-demanding applications
<ul style="list-style-type: none"> Great for difficult-to-grind materials (aluminum, brass, bronze, stainless, carbon steel and titanium) 	<ul style="list-style-type: none"> Applications requiring an economical option

PART #	GRIT	STD. PKG.
TS (TYPE II)		
3/4"		
69957399601	24	100
69957399602	36	100
69957399603	40	100
69957399604	50	100
69957399605	60	100
69957399606	80	100
69957399607	100	100
69957399608	120	100
69957399609	150	100
69957399610	180	100
69957399611	240	100
69957399612	320	100
1"		
69957399613	24	100
69957399614	36	100
69957399615	40	100
69957399616	50	100
69957399617	60	100
69957399618	80	100
69957399619	100	100
69957399620	120	100
69957399621	150	100
69957399622	180	100
69957399623	240	100
69957399624	320	100

PART #	GRIT	STD. PKG.
TS (TYPE II)		
1-1/2"		
69957399625	24	100
69957399626	36	100
69957399627	40	100
69957399628	50	100
69957399629	60	100
69957399630	80	100
69957399631	100	100
69957399632	120	100
69957399633	150	100
69957399634	180	100
69957399635	240	100
69957399636	320	100
2"		
69957399637	24	100
69957399638	36	100
69957399639	40	100
69957399640	50	100
69957399641	60	100
69957399642	80	100
69957399643	100	100
69957399644	120	100
69957399645	150	100
69957399646	180	100
69957399647	240	100
69957399648	320	100

PART #	GRIT	STD. PKG.
TS (TYPE II)		
3"		
69957399649	24	50
69957399650	36	50
69957399651	40	50
69957399652	50	50
69957399653	60	50
69957399654	80	50
69957399655	100	50
69957399656	120	50
69957399657	150	50
69957399658	180	50
69957399659	240	50
69957399660	320	50
4"		
69957399661	36	50
69957399662	40	50
69957399663	50	50
69957399664	60	50
69957399665	80	50
69957399666	100	50
69957399667	120	50
69957399668	180	50



See back-up pads and accessories for these discs on pages 55-56.

PART #	GRIT	STD. PKG.
TR (TYPE III)		
3/4"		
69957399669	24	100
69957399670	36	100
69957399671	40	100
69957399672	50	100
69957399673	60	100
69957399674	80	100
69957399675	100	100
69957399676	120	100
69957399677	150	100
69957399678	180	100
69957399679	240	100
69957399680	320	100

PART #	GRIT	STD. PKG.
TR (TYPE III)		
1"		
69957399681	24	100
69957399682	36	100
69957399683	40	100
69957399684	50	100
69957399685	60	100
69957399686	80	100
69957399687	100	100
69957399688	120	100
69957399689	150	100
69957399690	180	100
69957399691	240	100
69957399692	320	100

PART #	GRIT	STD. PKG.
TR (TYPE III)		
1-1/2"		
69957399693	24	100
69957399694	36	100
69957399695	40	100
69957399696	50	100
69957399697	60	100
69957399698	80	100
69957399699	100	100
69957399700	120	100
69957399701	150	100
69957399702	180	100
69957399703	240	100
69957399704	320	100

PART #	GRIT	STD. PKG.
TR (TYPE III)		
2"		
69957399705	24	100
69957399706	36	100
69957399707	40	100
69957399708	50	100
69957399709	60	100
69957399710	80	100
69957399711	100	100
69957399712	120	100
69957399713	150	100
69957399714	180	100
69957399715	240	100
69957399716	320	100

PART #	GRIT	STD. PKG.
TR (TYPE III)		
3"		
69957399717	24	50
69957399718	36	50
69957399719	40	50
69957399720	50	50
69957399721	60	50
69957399722	80	50
69957399723	100	50
69957399724	120	50
69957399725	150	50
69957399726	180	50
69957399727	240	50
69957399728	320	50

PART #	GRIT	STD. PKG.
TR (TYPE III)		
4"		
69957399729	36	50
69957399730	40	50
69957399731	50	50
69957399732	60	50
69957399733	80	50
69957399734	100	50
69957399735	120	50
69957399736	180	50



See back-up pads and accessories for these discs on pages 55-56.

PART #	GRIT	STD. PKG.
TP (TYPE I)		
3/4"		
69957399737	24	100
69957399738	36	100
69957399739	40	100
69957399740	50	100
69957399741	60	100
69957399742	80	100
69957399743	100	100
69957399744	120	100
69957399745	150	100
69957399746	180	100
69957399747	240	100
69957399748	320	100
1"		
69957399749	24	100
69957399750	36	100
69957399751	40	100
69957399752	50	100
69957399753	60	100
69957399754	80	100
69957399755	100	100
69957399756	120	100
69957399757	150	100
69957399758	180	100
69957399759	240	100
69957399760	320	100

PART #	GRIT	STD. PKG.
TP (TYPE I)		
1-1/2"		
69957399761	24	100
69957399762	36	100
69957399763	40	100
69957399764	50	100
69957399765	60	100
69957399766	80	100
69957399767	100	100
69957399768	120	100
69957399769	150	100
69957399770	180	100
69957399771	240	100
69957399772	320	100
2"		
69957399773	24	100
69957399774	36	100
69957399775	40	100
69957399776	50	100
69957399777	60	100
69957399778	80	100
69957399779	100	100
69957399780	120	100
69957399781	150	100
69957399782	180	100
69957399783	240	100
69957399784	320	100

PART #	GRIT	STD. PKG.
TP (TYPE I)		
3"		
69957399785	24	50
69957399786	36	50
69957399787	40	50
69957399788	50	50
69957399789	60	50
69957399790	80	50
69957399791	100	50
69957399792	120	50
69957399793	150	50
69957399794	180	50
69957399795	240	50
69957399796	320	50
4"		
69957399797	36	50
69957399798	40	50
69957399799	50	50
69957399800	60	50
69957399801	80	50
69957399802	100	50
69957399803	120	50
69957399804	180	50



See back-up pads and accessories for these discs on pages 55-56.



Single-ply construction is designed for maximum conformability when conditioning, deburring and blending contoured surfaces and finishing aerospace and metal fabrication materials.

FEATURES	BENEFITS
<ul style="list-style-type: none"> Premium, versatile aluminum oxide abrasive in coarse to finer grit range 	<ul style="list-style-type: none"> Eliminates gouging of work piece Ideal when initial cost is a major buying criterion
<ul style="list-style-type: none"> Conformable, flexible 1-ply cloth construction 	<ul style="list-style-type: none"> Specifically designed to excel on contoured surfaces and finishing applications Ability to get into tight areas while maintaining required cut and life

PART #	GRIT	DISCS/PKG.	DISCS/CASE
TS (TYPE II)			
1-1/2"			
77696088231	24	100	100
77696088232	36	100	100
77696088233	40	100	100
77696088234	50	100	100
77696088235	60	100	100
77696088236	80	100	100
77696088237	100	100	100
77696088238	120	100	100
77696088239	150	100	100
77696088240	180	100	100
77696088241	240	100	100
77696088242	320	100	100
2"			
77696088243	24	100	100
77696088244	36	100	100
77696088245	40	100	100
77696088246	50	100	100
77696088247	60	100	100
77696088248	80	100	100
77696088249	100	100	100
77696088250	120	100	100
77696088251	150	100	100
77696088252	180	100	100
77696088253	240	100	100
77696088254	320	100	100
3"			
77696088255	24	50	50
77696088256	36	50	50
77696088257	40	50	50
77696088258	50	50	50
77696088259	60	50	50
77696088260	80	50	50
77696088261	100	50	50
77696088262	120	50	50
77696088263	150	50	50
77696088264	180	50	50
77696088265	240	50	50
77696088266	320	50	50

PART #	GRIT	DISCS/PKG.	DISCS/CASE
TYPE TR (TYPE III)			
2"			
77696088267	24	50	50
77696088268	36	50	50
77696088269	40	50	50
77696088270	50	50	50
77696088271	60	50	50
77696088272	80	50	50
77696088273	100	50	50
77696088274	120	50	50
77696088275	150	50	50
77696088276	180	50	50
77696088277	240	50	50
77696088278	320	50	50
3"			
77696088279	24	50	50
77696088280	36	50	50
77696088281	40	50	50
77696088282	50	50	50
77696088283	60	50	50
77696088284	80	50	50
77696088285	100	50	50
77696088286	120	50	50
77696088287	150	50	50
77696088288	180	50	50
77696088289	240	50	50
77696088290	320	50	50



See back-up pads and accessories for these discs on pages 55-56.

QUICK-CHANGE BACK-UP PADS

Accessory

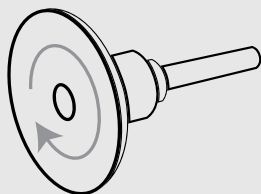

- Hard density back-up pads are for aggressive cutting action
- Medium density back-up pads are for all-purpose applications
- Soft density back-up pads are used for contours and fine finishing work



TS (TYPE II)



TR (TYPE III)



TP (TYPE I)

PART #	SIZE (D)	DENSITY	RPM	STD. PKG.
TS (TYPE II)				
66261054014	9/16"	Medium	40,000	1
08834164206	3/4"	Medium	40,000	1
08834164651	1"	Medium	40,000	1
08834164622	1-1/2"	Hard	30,000	1
08834164146	1-1/2"	Medium	30,000	1
08834164624	2"	Hard	30,000	1
08834164198	2"	Medium	30,000	1
08834161625	2"	Soft	30,000	1
08834161626	3"	Hard	20,000	1
08834164113	3"	Medium	20,000	1
08834164626	3"	Soft	20,000	1
08834164135	4"	Medium	15,000	1
TR (TYPE III)				
08834164038	3/4"	Medium	40,000	1
08834164037	1"	Medium	40,000	1
08834164640	1-1/2"	Hard	30,000	1
08834161174	1-1/2"	Medium	30,000	1
08834164643	2"	Hard	30,000	1
08834164922	2"	Medium	30,000	1
08834164641	2"	Soft	30,000	1
08834164036	3"	Hard	20,000	1
08834164949	3"	Medium	20,000	1
08834164644	3"	Soft	20,000	1
08834164655	4"	Medium	15,000	1

PART #	SIZE (D)	DENSITY	RPM	STD. PKG.
TP (TYPE I)				
66261054013	9/16"	Medium	40,000	1
08834164001	3/4"	Medium	40,000	1
08834164002	1"	Medium	40,000	1
08834163996	1-1/2"	Hard	30,000	1
08834164003	1-1/2"	Medium	30,000	1
08834163997	2"	Hard	30,000	1
08834164004	2"	Medium	30,000	1
08834163949	2"	Soft	30,000	1
08834163998	3"	Hard	20,000	1
08834164005	3"	Medium	20,000	1
08834163948	3"	Soft	20,000	1
08834164006	4"	Medium	15,000	1

All Quick-Change back-up pads have a 1/4" solid steel shank. Std. Pkg. = 1

REPLACEMENT MEDIUM DENSITY RUBBER PADS FOR QUICK-CHANGE BACK-UP PADS

Accessory



When the rubber pad has worn away, but the steel components of your quick-change back-up are still serviceable, order these replacement rubber pads.

PART #	DIAMETER	MODEL NO.	STD. PKG.
TP (TYPE I)			
08834164008	3/4"	RR75	1
08834164009	1"	RR10	1
08834164011	2"	RR20	1
08834164012	3"	RR30	1
08834164013	4"	RR40	1

REPLACEMENT ASSEMBLIES AND SHANKS FOR QUICK-CHANGE BACK-UP PADS

Accessory

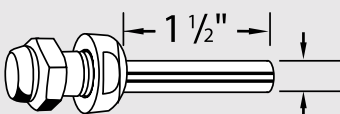

Assemblies replace all the steel components of a quick-change back-up pad. This shank replaces the screw-in 1/4" solid steel shank only.

PART #	DESCRIPTION	STD. PKG.
REPLACEMENT MANDRELS AND NUT ASSEMBLY		
08834164015	TP (Type I) Assembly RMN1 for 3/4" - 2"	1
08834164016	TP (Type I) Assembly RMN3 for 3" - 4"	1
08834164303	TS (Type II) & TR (Type III) Replacement 1/4" Shank	1

EXTENSION MANDRELS AND ASSEMBLY FOR QUICK-CHANGE DISCS

Accessory

Convert a TP (Type I) back-up pad 1/4" diameter solid shank to a threaded shank.



PART #	DIAMETER	MODEL NO.	LENGTH	STD. PKG.
EXTENSION MANDRELS AND ASSEMBLY – TP (TYPE I)				
08834164017	3/4 - 2	EMN-14	4"	1
08834164018	3/4 - 2	EMN-16	6"	1
08834164019	3/4 - 2	EMN-18	8"	1
08834164020	3 - 4	EMN-34	4"	1
08834164026	3 - 4	EMN-36	6"	1
08834164021	3 - 4	EMN-38	8"	1

MNA-1 PAD ADAPTERS FOR QUICK-CHANGE DISCS

Accessory

Convert a TP (Type I) back-up pad 1/4" diameter solid shank to a threaded shank.

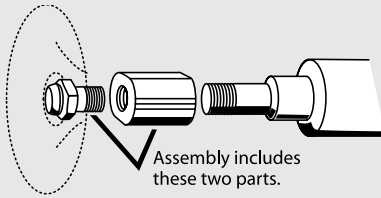

PART #	DISC DIAMETER	MODEL NO.	STD. PKG.
MNA-1 PAD ADAPTERS – TP (TYPE I)			
08834161176	3/4" - 2"	MNA 1/4-20 THD.	1
08834164055	3/4" - 2"	MNA 3/8-24	1
08834163001	3/4" - 2"	MNA 5/8-11	1
08834163002	3" - 4"	MNA 1/4-20	1
08834164041	3" - 4"	MNA 3/8-24	1
08834164028	3" - 4"	MNA 5/8-11	1

MNA-23 PAD ADAPTERS FOR QUICK-CHANGE DISCS

Accessory

For use on a right angle grinder: convert TS (Type II) and TR (Type III) back-up pad 1/4" diameter solid shanks to threaded shanks. The larger 5/8"-11 adapter (For 4-1/2" discs) is used alone to convert to a 5/8"-11 thread. The 3/8"-24 insert (for 4" discs) is screwed into the 5/8"-11 adapter to create a 3/8"-24 thread adapter.

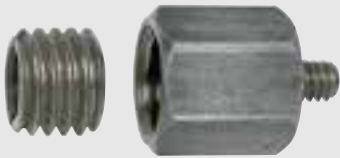

PART #	DISC DIAMETER	MODEL NO.	STD. PKG.
MNA-23 PAD ADAPTERS – TS (TYPE II) AND TR (TYPE III)			
08834162764	3/4" - 4"	MNA-23 3/8-24 5/8"-11 THD.	1

1/4" DIAMETER EXTENSION MANDREL FOR QUICK-CHANGE DISCS

Accessory

Use with TP (Type I), TS (Type II), or TR (Type III).



PART #	MODEL NO.	LENGTH	STD. PKG.
1/4" DIAMETER EXTENSION MANDREL 1/4-20 THREAD			
08834154185	EM-144	4"	1
08834154186	EM-146	6"	1
08834154187	EM-148	8"	1



STARTING RECOMMENDATIONS BY MATERIAL/APPLICATION

MATERIAL	HEAVY-DUTY	GENERAL-DUTY
Aluminum	YP 1186 W, YP 0998 W, XP 0998 W	XP 0998 W, YP 0998 W
Brass/Bronze	YP 1186 W, YP 0998 W, XP 0998 W	
Carbon Steel	YP 1186 W, YP 2079 W	XP 0998 W, YP 0998 W
Cast Iron	YP 1186 W, YP 0998 W, XP 0998 W	
Die Castings	YP 0998 W, XP 0998 W	
Glass, Ceramic	YC 1186 O	
Inconel	YP 2079 W	
Stainless Steel & Alloys	YP 2079 W, YP 1186 W	XP 0998 W, YP 0998 W
Titanium	YP 2079 W	
Wood	YC 1186 O, YP 0998 W, XP 0998 W	XC 0776 O, XP 0998 W, YP 0998 W
RECOMMENDED GRIT SELECTION		
Rough/Heavy-Duty 24-50	Intermediate 60-100	Finishing/Polishing 120-180

TROUBLESHOOTING GUIDE

SUGGESTED CORRECTION – CONTACT WHEELS

PROBLEM	HARDER WHEEL	SOFTER WHEEL	LARGER GROOVE/ LAND	SMALLER GROOVE/ LAND	DRESS WHEEL	HIGHER SPEED	LOWER SPEED	STANDARD SERRATION	LARGER WHEEL	SMALLER WHEEL
Dulling	•		•				•			•
Loading			•							•
Over-aggressiveness		•		•				•	•	
Slow cutting	•		•			•				•
Scratches too deep		•		•				•	•	
Burning	•						•			
Non-conformity		•	•				•		•	
Dubbing edges	•									
Shedding (abrasives)		•		•	•	•		•	•	
Chatter		•						•	•	

SUGGESTED CORRECTION – GENERAL

PROBLEM	CORRECTION
Loading	Decrease infeed pressure or belt speed
Shedding	Reduce applied pressure Use a less aggressive contact wheel Dress contact wheel if worn or damaged Use entire surface of belt
Belt Breakage	Reduce belt tension Use less aggressive contact wheel Check tracking mechanism for belts tracking erratically
Reduced belt Life	Use coarser grit Reduce pressure

The choice for hard-to-grind alloys and heat-sensitive applications.

FEATURES

- Patented ceramic alumina abrasive
- Durable Y-weight polyester waterproof cloth backing
- Grinding aid coating

BENEFITS

- Exceptional life and value
- Aggressive cut rate
- Sharpness maintained throughout life of the belt
- Maximum grain adhesion, reduced edge-fray and strong body retention result in longer life and product consistency
- Cooler cut, burn-free grinding of heat-sensitive materials
- Minimizes loading

PART #	GRADING		BELTS/PKG.	BELTS/CASE
1/8" x 12"				
05539554610	P36	YP 2079 W	10	10
05539554611	P40	YP 2079 W	10	10
05539554612	P60	YP 2079 W	10	10
05539554613	P80	YP 2079 W	10	10
1/8" x 18"				
05539554618	P36	YP 2079 W	10	10
05539554619	P40	YP 2079 W	10	10
05539554620	P60	YP 2079 W	10	10
05539554621	P80	YP 2079 W	10	10
1/4" x 12"				
05539554626	P36	YP 2079 W	10	10
05539554627	P40	YP 2079 W	10	10
05539554628	P60	YP 2079 W	10	10
05539554629	P80	YP 2079 W	10	10
1/4" x 18"				
05539554634	P36	YP 2079 W	10	10
05539554635	P40	YP 2079 W	10	10
05539554636	P60	YP 2079 W	10	10
05539554637	P80	YP 2079 W	10	10
1/4" x 24"				
05539554642	P36	YP 2079 W	10	10
05539554643	P40	YP 2079 W	10	10
05539554644	P60	YP 2079 W	10	10
05539554645	P80	YP 2079 W	10	10
1/2" x 12"				
05539554655	P36	YP 2079 W	10	10
05539554656	P40	YP 2079 W	10	10
05539554657	P50	YP 2079 W	10	10
05539554658	P60	YP 2079 W	10	10
05539554659	P80	YP 2079 W	10	10

PART #	GRADING		BELTS/PKG.	BELTS/CASE
1/2" x 18"				
05539554665	P36	YP 2079 W	10	10
05539554666	P40	YP 2079 W	10	10
05539554667	P50	YP 2079 W	10	10
05539554668	P60	YP 2079 W	10	10
05539554669	P80	YP 2079 W	10	10
1/2" x 24"				
05539554676	P36	YP 2079 W	10	10
05539554677	P40	YP 2079 W	10	10
05539554678	P50	YP 2079 W	10	10
05539554679	P60	YP 2079 W	10	10
05539554680	P80	YP 2079 W	10	10
3/4" x 18"				
05539554686	P36	YP 2079 W	10	10
05539554687	P40	YP 2079 W	10	10
05539554688	P50	YP 2079 W	10	10
05539554689	P60	YP 2079 W	10	10
05539554690	P80	YP 2079 W	10	10
3/4" x 20-1/2"				
05539554696	P36	YP 2079 W	10	10
05539554697	P40	YP 2079 W	10	10
05539554698	P50	YP 2079 W	10	10
05539554699	P60	YP 2079 W	10	10
05539554700	P80	YP 2079 W	10	10



techtip

A light-bodied grease applied to the belt surface will greatly enhance the belt life when grinding non-ferrous materials such as aluminum, brass, bronze and copper.



It is the user's responsibility to refer to and comply with ANSI B7.7





Designed for all metalworking, finishing and contour and shape sanding applications requiring flexibility and fray resistance.

FEATURES	BENEFITS
• Tough, P-graded, heat-treated aluminum oxide abrasive	• Aggressive yet cool cutting
• Full resin bond system	• Excellent edge adhesion
• Flexible, X- and Y-weight polyester backing	• Tear and fray resistance
• Butt tape joint	• Reversible, durable

PART #	GRADING		BELTS/PKG.	BELTS/CASE
1/8" x 12"				
05539554606	P40	YP 0998 W	10	10
05539554607	P60	YP 0998 W	10	10
05539554608	P80	YP 0998 W	10	10
05539554609	P120	XP 0998 W	10	10
1/8" x 18"				
05539554614	P40	YP 0998 W	10	10
05539554615	P60	YP 0998 W	10	10
05539554616	P80	YP 0998 W	10	10
05539554617	P120	XP 0998 W	10	10
1/4" x 12"				
05539554622	P40	YP 0998 W	10	10
05539554623	P60	YP 0998 W	10	10
05539554624	P80	YP 0998 W	10	10
05539554625	P120	XP 0998 W	10	10
1/4" x 18"				
05539554630	P40	YP 0998 W	10	10
05539554631	P60	YP 0998 W	10	10
05539554632	P80	YP 0998 W	10	10
05539554633	P120	XP 0998 W	10	10
1/4" x 24"				
05539554638	P40	YP 0998 W	10	10
05539554639	P60	YP 0998 W	10	10
05539554640	P80	YP 0998 W	10	10
05539554641	P120	XP 0998 W	10	10
3/8" x 13"				
05539554646	P40	YP 0998 W	10	10
05539554647	P60	YP 0998 W	10	10
05539554648	P80	YP 0998 W	10	10
05539554649	P120	XP 0998 W	10	10
1/2" x 12"				
05539554650	P40	YP 0998 W	10	10
05539554651	P50	YP 0998 W	10	10
05539554652	P60	YP 0998 W	10	10
05539554653	P80	YP 0998 W	10	10
05539554654	P120	XP 0998 W	10	10
1/2" x 18"				
05539554660	P40	YP 0998 W	10	10
05539554661	P50	YP 0998 W	10	10
05539554662	P60	YP 0998 W	10	10
05539554663	P80	YP 0998 W	10	10
05539554664	P120	XP 0998 W	10	10

PART #	GRADING		BELTS/PKG.	BELTS/CASE
1/2" x 24"				
05539554670	P40	YP 0998 W	10	10
05539554671	P50	YP 0998 W	10	10
05539554672	P60	YP 0998 W	10	10
05539554673	P80	YP 0998 W	10	10
05539554674	P100	XP 0998 W	10	10
05539554675	P120	XP 0998 W	10	10
3/4" x 18"				
05539554681	P40	YP 0998 W	10	10
05539554682	P50	YP 0998 W	10	10
05539554683	P60	YP 0998 W	10	10
05539554684	P80	YP 0998 W	10	10
05539554685	P120	XP 0998 W	10	10
3/4" x 20-1/2"				
05539554691	P40	YP 0998 W	10	10
05539554692	P50	YP 0998 W	10	10
05539554693	P60	YP 0998 W	10	10
05539554694	P80	YP 0998 W	10	10
05539554695	P120	XP 0998 W	10	10
1" x 12"				
05539554701	P40	YP 0998 W	10	10
05539554702	P50	YP 0998 W	10	10
05539554703	P60	YP 0998 W	10	10
05539554704	P80	YP 0998 W	10	10
05539554705	P120	XP 0998 W	10	10
1" x 24"				
05539554706	P40	YP 0998 W	10	10
05539554707	P50	YP 0998 W	10	10
05539554708	P60	YP 0998 W	10	10
05539554709	P80	YP 0998 W	10	10
05539554710	P120	XP 0998 W	10	10
1" x 30"				
05539554711	P40	YP 0998 W	10	10
05539554712	P50	YP 0998 W	10	10
05539554713	P60	YP 0998 W	10	10
05539554714	P80	YP 0998 W	10	10
05539554715	P120	XP 0998 W	10	10



PREMIER RED PORTABLE BELTS

Better Tier / Zirconia Alumina Resin Cloth Open



Excellent for finishing wood and non-metallic materials.

FEATURES	BENEFITS
• Zirconia alumina abrasive	• Aggressive, rapid cut rate
• Y-weight cotton backing	• Extended life
• Open coat	• Reduced loading
• Butt tape joint	• Reversible, excellent durability
• Packaged in convenient, durable contractor packs	• Job specific labeling; easy product identification
	• Ideal for walk-in trade, showroom displays

PART #	GRADING		BELTS/PKG.	BELTS/CASE
3" x 21"				
05539563668	36	YC 1186 O	5	25
05539554807	40	YC 1186 O	5	25
05539563667	50	YC 1186 O	5	25
05539554808	60	YC 1186 O	5	25
05539563666	80	YC 1186 O	5	25
05539563665	120	YC 1186 O	5	25
3" x 24"				
05539554817	40	YC 1186 O	5	25
05539563671	50	YC 1186 O	5	25
05539554818	60	YC 1186 O	5	25
05539563670	80	YC 1186 O	5	25
05539554819	100	YC 1186 O	5	25
05539563669	120	YC 1186 O	5	25

PART #	GRADING		BELTS/PKG.	BELTS/CASE
4" x 24"				
05539563676	36	YC 1186 O	5	25
05539554828	40	YC 1186 O	5	25
05539563675	50	YC 1186 O	5	25
05539554829	60	YC 1186 O	5	25
05539563674	80	YC 1186 O	5	25
05539554830	100	YC 1186 O	5	25
05539563673	120	YC 1186 O	5	25



ALUMINUM OXIDE PORTABLE BELTS

Good Tier / Aluminum Oxide Resin Waterproof Cloth



Ideal for sanding metal and all species of wood.

FEATURES	BENEFITS
• Aluminum oxide abrasive	• Tough and durable with aggressive cutting action
• Full resin bond system	• Increased strength
• Flexible, X- and Y-weight polyester backing	• Cool operating on platen sanders
• Butt tape joint	• Reversible, excellent durability

PART #	GRADING		BELTS/PKG.	BELTS/CASE
3" x 21"				
05539554799	P36	YP 0998 W	5	25
05539554800	P40	YP 0998 W	5	25
05539554801	P50	YP 0998 W	5	25
05539554802	P60	YP 0998 W	5	25
05539554803	P80	YP 0998 W	5	25
05539554804	P100	XP 0998 W	5	25
05539554805	P120	XP 0998 W	5	25
05539554806	P150	XP 0998 W	5	25
3" x 24"				
05539554809	P36	YP 0998 W	5	25
05539554810	P40	YP 0998 W	5	25
05539554811	P50	YP 0998 W	5	25
05539554812	P60	YP 0998 W	5	25
05539554813	P80	YP 0998 W	5	25
05539554814	P100	XP 0998 W	5	25
05539554815	P120	XP 0998 W	5	25
05539554816	P150	XP 0998 W	5	25



PART #	GRADING		BELTS/PKG.	BELTS/CASE
4" x 24"				
05539554820	P36	YP 0998 W	5	25
05539554821	P40	YP 0998 W	5	25
05539554822	P50	YP 0998 W	5	25
05539554823	P60	YP 0998 W	5	25
05539554824	P80	YP 0998 W	5	25
05539554825	P100	XP 0998 W	5	25
05539554826	P120	XP 0998 W	5	25
05539554827	P150	XP 0998 W	5	25

PREMIER RED NARROW BELTS

Better Tier / Zirconia Alumina Resin Cloth

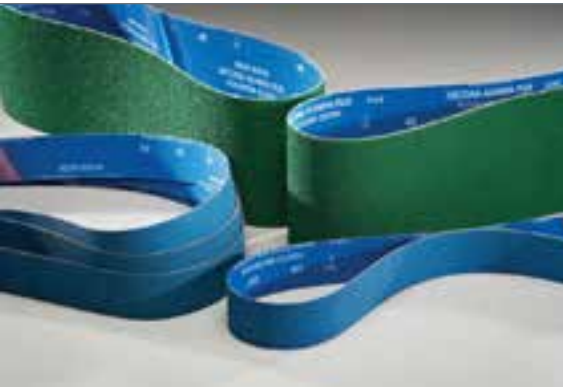

Excellent on ferrous and non-ferrous applications.

FEATURES	BENEFITS
• Zirconia alumina abrasive	• Aggressive, rapid cut rate
• Full resin bond system	• Increased strength
• Durable, Y-weight polyester backing	• Extended life
• YP 1288 R contains a grinding aid coating	• Cool grinding of heat-sensitive alloys (Inconel, titanium, stainless steel, etc.)
• Butt tape joint	• Reversible, excellent durability

PART #	GRADING		BELTS/PKG.	BELTS/CASE
2" x 48"				
05539554739	P36	YP 1186 W	5	5
05539554740	P40	YP 1186 W	5	5
05539554741	P50	YP 1186 W	5	5
05539554742	P60	YP 1186 W	5	5
05539554743	P80	YP 1186 W	5	5

PART #	GRADING		BELTS/PKG.	BELTS/CASE
6" X 48"				
05539554850	P36	YP 1288 R	5	5
05539554851	P40	YP 1288 R	5	5
05539554852	P50	YP 1288 R	5	5
05539554853	P60	YP 1288 R	5	5
05539554854	P80	YP 1288 R	5	5
05539554855	P100	YP 1288 R	5	5
05539554856	P120	YP 1288 R	5	5



ALUMINUM OXIDE NARROW BELTS

Good Tier / Aluminum Oxide Resin Waterproof Cloth

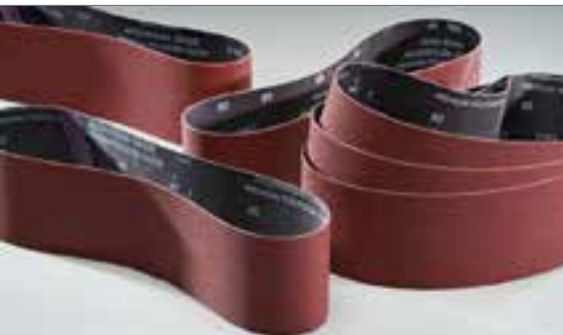

Ideal for operations requiring a belt specification that does not generate heat, but is capable of sanding a variety of materials. Closed coat for fast metal removal.

FEATURES	BENEFITS
• Aluminum oxide abrasive	• Versatile
• Full resin bond system	• Tough and durable with aggressive cutting action
• Flexible, X- and Y-weight polyester backing	• Increased strength
• Butt tape joint	• Cool operating on platen sanders
	• Reversible, durable

PART #	GRADING		BELTS/PKG.	BELTS/CASE
1" x 42"				
05539554716	P40	YP 0998 W	5	5
05539554717	P50	YP 0998 W	5	5
05539554718	P60	YP 0998 W	5	5
05539554719	P80	YP 0998 W	5	5
05539554720	P100	XP 0998 W	5	5
05539554721	P120	XP 0998 W	5	5
1-1/2" x 60"				
05539554722	P40	YP 0998 W	5	5
05539554723	P50	YP 0998 W	5	5
05539554724	P60	YP 0998 W	5	5
05539554725	P80	YP 0998 W	5	5
05539554726	P120	XP 0998 W	5	5
05539554727	P220	XP 0998 W	5	5

PART #	GRADING		BELTS/PKG.	BELTS/CASE
2" x 48"				
05539554728	P36	YP 0998 W	5	5
05539554729	P40	YP 0998 W	5	5
05539554730	P50	YP 0998 W	5	5
05539554731	P60	YP 0998 W	5	5
05539554732	P80	YP 0998 W	5	5
05539554733	P100	XP 0998 W	5	5
05539554734	P120	XP 0998 W	5	5
05539554735	P150	XP 0998 W	5	5
05539554736	P180	XP 0998 W	5	5
05539554737	P220	XP 0998 W	5	5
05539554738	P320	XP 0998 W	5	5

Continued on next page.



Good Tier / Aluminum Oxide Resin Waterproof Cloth

PART #	GRADING		BELTS/PKG.	BELTS/CASE
2" x 60"				
05539554744	P36	YP 0998 W	5	5
05539554745	P40	YP 0998 W	5	5
05539554746	P50	YP 0998 W	5	5
05539554747	P60	YP 0998 W	5	5
05539554748	P80	YP 0998 W	5	5
05539554749	P120	XP 0998 W	5	5
05539554750	P150	XP 0998 W	5	5
05539554751	P180	XP 0998 W	5	5
05539554752	P220	XP 0998 W	5	5
05539554753	P320	XP 0998 W	5	5
05539554754	P400	XP 0998 W	5	5
2" x 72"				
05539554755	P36	YP 0998 W	5	5
05539554756	P40	YP 0998 W	5	5
05539554757	P50	YP 0998 W	5	5
05539554758	P60	YP 0998 W	5	5
05539554759	P80	YP 0998 W	5	5
05539554760	P120	XP 0998 W	5	5
2-1/2" x 48"				
05539554772	P36	YP 0998 W	5	5
05539554773	P40	YP 0998 W	5	5
05539554774	P50	YP 0998 W	5	5
05539554775	P60	YP 0998 W	5	5
05539554776	P80	YP 0998 W	5	5
05539554777	P120	XP 0998 W	5	5

PART #	GRADING		BELTS/PKG.	BELTS/CASE
2-1/2" x 60"				
05539554778	P36	YP 0998 W	5	5
05539554779	P40	YP 0998 W	5	5
05539554780	P50	YP 0998 W	5	5
05539554781	P60	YP 0998 W	5	5
05539554782	P80	YP 0998 W	5	5
05539554783	P120	XP 0998 W	5	5
4" x 36"				
05539554832	P36	YP 0998 W	5	5
05539554833	P40	YP 0998 W	5	5
05539554834	P50	YP 0998 W	5	5
05539554835	P60	YP 0998 W	5	5
05539554836	P80	YP 0998 W	5	5
05539554837	P120	XP 0998 W	5	5
6" x 48"				
05539554843	P36	YP 0998 W	5	5
05539554844	P40	YP 0998 W	5	5
05539554845	P50	YP 0998 W	5	5
05539554846	P60	YP 0998 W	5	5
05539554847	P80	YP 0998 W	5	5
05539554848	P100	XP 0998 W	5	5
05539554849	P120	XP 0998 W	5	5



MEDALIST NARROW BELTS

Best Tier / Ceramic Alumina Resin Waterproof Cloth



The choice for hard-to-grind alloys and heat-sensitive applications.

FEATURES	BENEFITS
<ul style="list-style-type: none"> Patented ceramic alumina abrasive 	<ul style="list-style-type: none"> Exceptional life and value Aggressive cut rate Sharpness maintained throughout life of the belt
<ul style="list-style-type: none"> Durable Y-weight polyester waterproof cloth backing 	<ul style="list-style-type: none"> Maximum grain adhesion, reduced edge-fray and strong body retention result in longer life and product consistency
<ul style="list-style-type: none"> Grinding aid coating 	<ul style="list-style-type: none"> Cooler cut, burn-free grinding of heat-sensitive materials Minimizes loading

PART #	GRADING		BELTS/PKG.	BELTS/CASE
2" x 132"				
05539554767	P36	YP 2079 W	5	5
05539554768	P40	YP 2079 W	5	5
05539554769	P50	YP 2079 W	5	5
05539554770	P60	YP 2079 W	5	5
05539554771	P80	YP 2079 W	5	5

PART #	GRADING		BELTS/PKG.	BELTS/CASE
3" x 132"				
05539554790	P36	YP 2079 W	5	5
05539554791	P40	YP 2079 W	5	5
05539554792	P50	YP 2079 W	5	5
05539554793	P60	YP 2079 W	5	5
05539554794	P80	YP 2079 W	5	5



See FastTrack Belt Program on pages 65-66 for additional specifications and sizes.

PREMIER RED NARROW BELTS
Better Tier / Zirconia Alumina Resin Waterproof Cloth



Applications include weld removal and the finishing of ferrous and non-ferrous materials. The choice for heaviest pressure applications.

FEATURES	BENEFITS
<ul style="list-style-type: none"> Zirconia alumina abrasive 	<ul style="list-style-type: none"> Ultra tough, aggressive Self-sharpening, cool cutting
<ul style="list-style-type: none"> Full resin bond system 	<ul style="list-style-type: none"> Increased strength
<ul style="list-style-type: none"> Durable Y-weight polyester, waterproof cloth backing 	<ul style="list-style-type: none"> Maximum grain adhesion, reduced edge-fray and strong body retention result in longer life and product consistency
<ul style="list-style-type: none"> Waterproof 	<ul style="list-style-type: none"> Use wet or dry

PART #	GRADING	BELTS/PKG.	BELTS/CASE
3" x 132"			
05539554795	P40 YP 1186 W	5	5
05539554796	P50 YP 1186 W	5	5
05539554797	P60 YP 1186 W	5	5
05539554798	P80 YP 1186 W	5	5



ALUMINUM OXIDE NARROW BELTS
Good Tier / Aluminum Oxide Resin Waterproof Cloth



General purpose belt for sanding ferrous and non-ferrous materials.

FEATURES	BENEFITS
<ul style="list-style-type: none"> Aluminum oxide abrasive 	<ul style="list-style-type: none"> Durable, with aggressive cutting action The economical choice for a wide range of applications
<ul style="list-style-type: none"> Full resin bond system 	<ul style="list-style-type: none"> Increased strength
<ul style="list-style-type: none"> Flexible X- and Y-weight polyester backing 	<ul style="list-style-type: none"> Durable Resistant to heat

PART #	GRADING	BELTS/PKG.	BELTS/CASE
2" x 132"			
05539554761	P36 YP 0998 W	5	5
05539554762	P40 YP 0998 W	5	5
05539554763	P50 YP 0998 W	5	5
05539554764	P60 YP 0998 W	5	5
05539554765	P80 YP 0998 W	5	5
05539554766	P120 XP 0998 W	5	5
3" x 132"			
05539554784	P36 YP 0998 W	5	5
05539554785	P40 YP 0998 W	5	5
05539554786	P50 YP 0998 W	5	5
05539554787	P60 YP 0998 W	5	5
05539554788	P80 YP 0998 W	5	5
05539554789	P120 XP 0998 W	5	5



PART #	GRADING	BELTS/PKG.	BELTS/CASE
4" x 132"			
05539554838	P36 YP 0998 W	5	5
05539554839	P40 YP 0998 W	5	5
05539554840	P60 YP 0998 W	5	5
05539554841	P80 YP 0998 W	5	5
05539554842	P100 XP 0998 W	5	5

BELT CLEANING STICK
Accessory



This solid rubber cleaning stick is designed to remove wood and other non-metallic materials that build up on narrow belts during use. Apply it to the face of the belt while running to remove unwanted materials and increase cut rate and overall life of the belt.

PART #	SIZE	STD. PKG.
05539514745	8 x 1-3/4 x 1-3/4	1

ALUMINUM OXIDE WIDE BELTS
Good Tier / Aluminum Oxide Resin Cloth Open

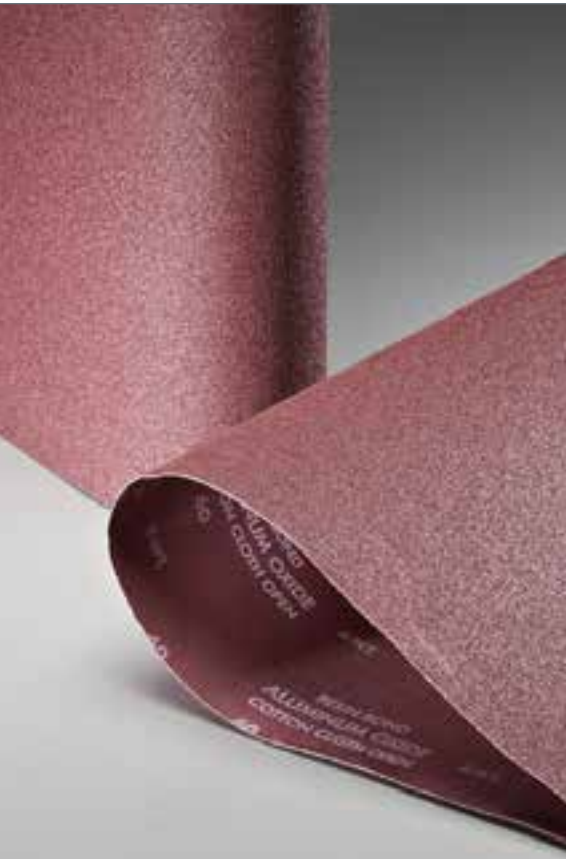

Applications include finishing of wood and non-ferrous metals.

FEATURES	BENEFITS
• Light brown aluminum oxide abrasive	• Uniform scratch pattern
• Full resin bond system	• Increased strength
• X-weight cotton backing	• Resists loading
• Open coat	

PART #	GRADING		BELTS/PKG.	BELTS/CASE
25" x 75"				
05539599963	80	XC 0776 0	3	3
37" x 60"				
05539599978	60	XC 0776 0	3	3
05539599977	80	XC 0776 0	3	3
05539599976	100	XC 0776 0	5	5
05539599975	120	XC 0776 0	5	5
05539599974	150	XC 0776 0	5	5
05539599973	180	XC 0776 0	5	5
37" x 75"				
05539599992	60	XC 0776 0	3	3
05539599991	80	XC 0776 0	3	3
05539599990	100	XC 0776 0	5	5
05539599989	120	XC 0776 0	5	5
05539599988	150	XC 0776 0	5	5
05539599987	180	XC 0776 0	5	5



FastTRACK™
 SERVICE

See FastTrack Belt Program on pages 65-66 for additional specifications and sizes.

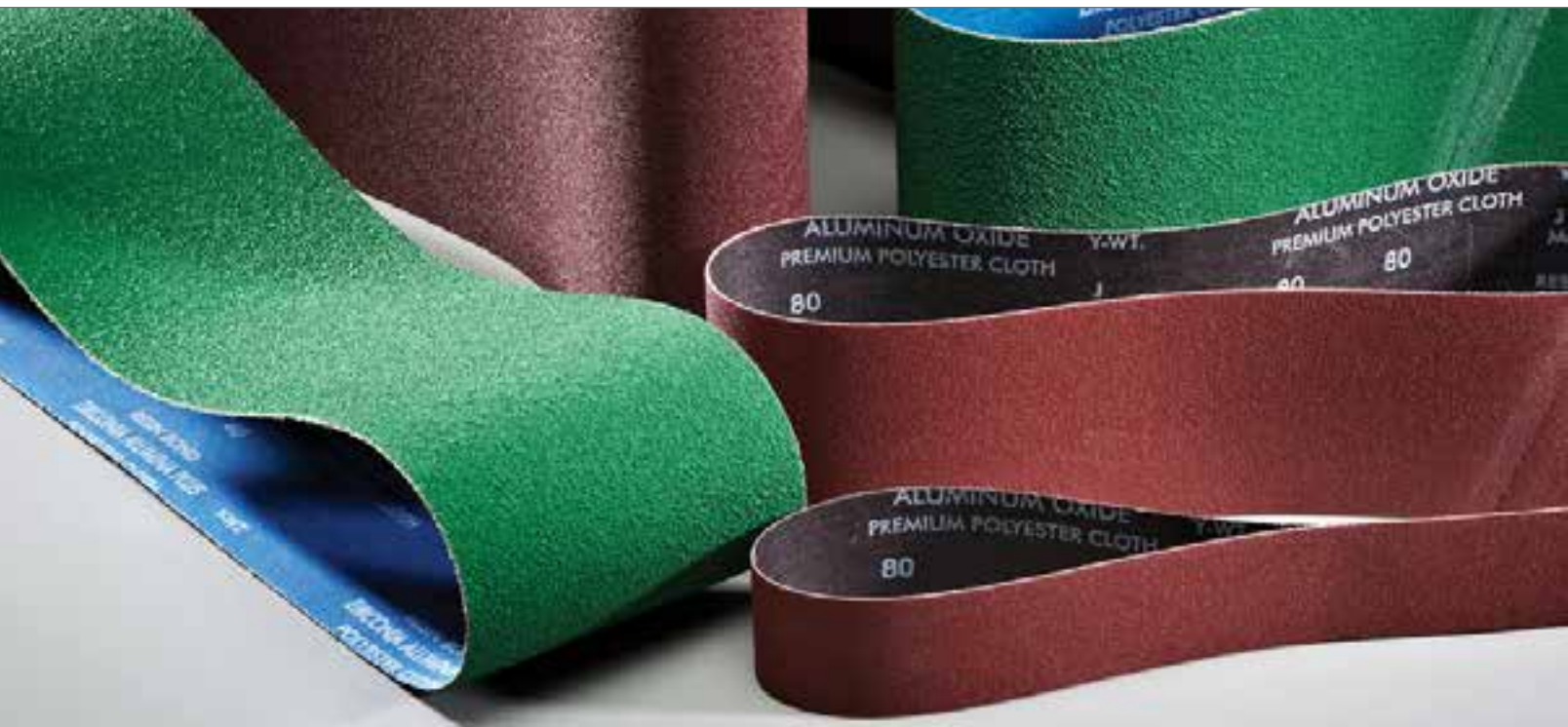

Manufacturing lead-time is two days for narrow belts (1/2" – 12" wide) and three days for wide belts (14 – 52" wide). Please see the FastTrack chart below for complete details on availability and lead-times.

Carborundum FastTrack Belt Service offers you all of the advantages of an ISO 9001 quality manufacturer and the advantages of a coated abrasive belt express service.

PRODUCT AVAILABILITY

- Medalist
- PremRed
- Gold
- Gold X

MANUFACTURING LEEWAY

- +/-10%

SIZE AVAILABILITY

- Maximum width: 52"
- 1/2" and greater widths, for 25" and greater lengths

NEW ONLINE IMMEDIATE BELT QUOTE TOOL!

- Check the FastTrack product availability on the next page
- Include a full description of belt required, including: quantity, dimensions, grit size, and FastTrack belt name: Medalist, PremRed, Gold or GoldX.
- Check splice and flex availability (on next page). FastTrack belt service is limited to standard joint and flex
- Verify that the quantity is within FastTrack limits
- Send order electronically, fax, or phone to customer service
- When ordering a belt that does not have an existing part number, please call Customer Service to expedite part number creation

FASTTRACK ORDERING QUANTITIES AND LEAD-TIMES

WIDTH	GRIT SIZE	MINIMUM ORDER QUANTITY	CASE QUANTITY	MAXIMUM ORDER QTY. (EQUALS 2 CASES)	CONVERSION LEAD-TIME (DAYS)
NARROW BELTS					
1/2" through 1"	All	50	200	400	2
Over 1" through 5"	All	10	50	100	2
Over 5" through 9"	All	10	20	40	2
Over 9" through 14"	All	10	10	20	2
WIDE BELTS					
Over 14" through 20"	All	5	10	20	3
Over 20" through 52"	All	5	5	10	3

FastTrack belt service applies to belts 25" and greater in length

FASTTRACK BELTS AVAILABILITY

TIER	ORDER AS*	GRIT SIZE	ABRASIVE GRAIN	BACKING	JOINT*	FLEX*	APPLICATIONS
Best	MEDALIST	24-80	Ceramic Alumina	Y-wt. Polyester	BJ	RR	Ceramic grain with special grinding aid, designed for grinding hard-to-grind alloys and heat-sensitive jobs
Better	PREMRED	24-120	Zirconia Alumina	Y-wt. Polyester	BJ	RR	Zirconia alumina grain, with grinding aid, for grinding heat-sensitive alloys: Inconel, titanium and stainless steel
Good	GOLD	P24-P80	Aluminum Oxide	Y-wt. Polyester	BJ	RR	Heat-treated aluminum oxide grain and strong polyester backing for ferrous and non ferrous materials
Good	GOLDX	P100-P400	Aluminum Oxide	X-wt. Polyester	BJ	RR	P-graded, heat-treated aluminum oxide grain and strong, and flexible polyester backing for ferrous and non ferrous materials

*FastTrack belts are available in standard flex and joint: BJ = extra strong conventional butt joint; RR = horizontal flex lines (90 deg. angle to edge) for lengthwise flexibility.

STOCK AND FASTTRACK BELT COMPETITIVE CROSS REFERENCE

CARBORUNDUM	3M	HERMES	VSM	KLINGSPOR	SIA	EKAMANT
CERAMIC ALUMINUM OXIDE – CLOTH						
MEDALIST (YP 2079 W)	963H, 960G, 960H, 970DZ, 984F, 761D, 761F, 777F, 951E, 741A, 747D, 977F, 967F, 987FI, 963G	CB440Y, RB426MX, CR456, CB441Z	SK750X, SK751X, SK840X, SK770X, SK847Y	CS612YY, CS610YY	—	—
ZIRCONIA ALUMINA – CLOTH						
PREMRED (YP 1288 RP)	590W, 562HZ, 591HZ, 561D, 563F, 591W, 960G, 960H, 741A, 577F, 567G, 561F, 551E, 741A, 741E, 761D, 761F, 777F, 977F	RB346-23MX, SB488Y OP, RB484Z, RB426-23MX, RB484TY, RB486X, RB486Y, RB480-21MX, CB440Y, RB486XF	ZK713X, KK717Y, KK715X, KK716Y, KK815Y, ZK744X, ZK713X	CS414YY, CS411X, CS411Y, CS409Y	C888 DP, 2800, 2803, 2929	UZA0X
ALUMINUM OXIDE – CLOTH						
GOLD (YP 0998 W)	363F, 261F, 361F, 353F	RB416Y, RB376TY, RB325X, SB378Y, SB378YR	KK711Y	CS412Y, CS341X	2982, C982 YP, 2803, 933A, 936A	UA0X
GOLDX (XP 0998 W)	270D, 270DZ, 272DZ, 260D, 362RZ, 201E, 203E, 204DZ, 212DZ, 240A, 240D, 240DZ, 231D, 241E, 261E, 311E, 331D, 351E, 353E, 200D, 200DZ, 330EZ, 340I, 241D, 251D, 261D, 248D, 707E	RB316 XOP, RB316-34XOP, RB232JF, CB432EJ, RB303 Flex, RB316 X-Flex, RB317LX, RB306JF, RB317J, RB316EJ, RB346MX, RB317JFW, RB406JF, RB306J, RB307JF, CB442EJ	KK504X, KK524X, KK511F, KK841F, KK524Y, KK524F, KK511X, KK532F, KK564F, KK711T, KK511J	CS311X, CS413Y, CS310X, LS309XH, CS310XF, CS311JF, LS312JF, LS309JF, LS319JF, CS311JF	C9030, C906YO, C903XO, 2820, 2828, 2920, C905X, C984XP, 2912, 2933, 2945, 2910, 2911, 2946, 2951, 2936	UA0X, RKX, PKJ, RKJ, RKJF, RKJFO, MKX, MKJFH, RKJFON

Ideal for cleaning and deburring metal surfaces. May be used dry or with oil.

FEATURES	BENEFITS
<ul style="list-style-type: none"> • P-graded, brown aluminum oxide abrasive • Advanced full resin bond system 	<ul style="list-style-type: none"> • Tough and durable • Exceptional grain adhesion for longer life
<ul style="list-style-type: none"> • JCF 0852: orange J-weight backing with increased flexibility • Dispenser boxed 	<ul style="list-style-type: none"> • Superior conformability to complex surfaces and better finishes • Convenience; cut or tear to length



PART #	GRADING		ROLLS/PKG.	ROLLS/CASE
1" x 10 YARDS – HANDY ROLLS				
05539529317	P80	JCF 0852	1	5
05539529316	P100	JCF 0852	1	5
05539529315	P120	JCF 0852	1	5
05539529314	P150	JCF 0852	1	5
05539529313	P180	JCF 0852	1	5
05539529312	P240	JCF 0852	1	5
05539529311	P320	JCF 0852	1	5
1" x 50 YARDS – ECONOMY ROLLS				
05539510141	P60	XC 0851	1	5
05539529328	P80	JCF 0852	1	5
05539529327	P100	JCF 0852	1	5
05539529326	P120	JCF 0852	1	5
05539529325	P150	JCF 0852	1	5
05539529324	P180	JCF 0852	1	5
05539529323	P220	JCF 0852	1	5
05539529322	P240	JCF 0852	1	5
05539529321	P280	JCF 0852	1	5
05539529320	P320	JCF 0852	1	5
05539529319	P400	JCF 0852	1	5
05539529318	P600	JCF 0852	1	5
1-1/2" x 50 YARDS – ECONOMY ROLLS				
05539510945	P50	XC 0851	1	5
05539510947	P60	XC 0851	1	5
05539529339	P80	JCF 0852	1	5
05539529338	P100	JCF 0852	1	5
05539529337	P120	JCF 0852	1	5
05539529336	P150	JCF 0852	1	5
05539529335	P180	JCF 0852	1	5
05539529334	P220	JCF 0852	1	5
05539529333	P240	JCF 0852	1	5
05539529332	P280	JCF 0852	1	5
05539529331	P320	JCF 0852	1	5
05539529330	P400	JCF 0852	1	5
05539529329	P600	JCF 0852	1	5

PART #	GRADING		ROLLS/PKG.	ROLLS/CASE
2" x 50 YARDS – ECONOMY ROLLS				
05539510585	P40	XC 0851	1	5
05539511102	P50	XC 0851	1	5
05539510340	P60	XC 0851	1	5
05539529350	P80	JCF 0852	1	5
05539529349	P100	JCF 0852	1	5
05539529348	P120	JCF 0852	1	5
05539529347	P150	JCF 0852	1	5
05539529346	P180	JCF 0852	1	5
05539529345	P220	JCF 0852	1	5
05539529344	P240	JCF 0852	1	5
05539529343	P280	JCF 0852	1	5
05539529342	P320	JCF 0852	1	5
05539529341	P400	JCF 0852	1	5
05539529340	P600	JCF 0852	1	5



techtip

Use light machine oil with cloth rolls as a lubricant for finer finishes and quicker cut.

! It is the user's responsibility to refer to and comply with ANSI B7.7



QUANTITY AVAILABILITY

WIDTH	MINIMUM QUANTITY	MAXIMUM QUANTITY
2" to 9"	5 rolls	10 rolls
>9" to 11"	4 rolls	8 rolls
>11" to 12"	3 rolls	6 rolls

Length = 50 yards for all FastTrack Rolls

CONVERSION TIME SIZE AVAILABILITY

- 5 days
- Widths: 2" – 12"
- Lengths: 50 yards

ORDERING IS EASY!

- Call your distributor for FastTrack roll guidelines.
- Include a full description of roll required, including: size, specification, grit size and quantity

MEDALIST GRIP-ON PAPER ROLLS
 Best Tier / Ceramic Alumina Dri-Lube Resin Paper Open



Best choice for paints, primers, plastics, fiberglass, wood and sealer sanding.

FEATURES	BENEFITS
<ul style="list-style-type: none"> • Medalist ceramic alumina abrasive, P80 - P600 	<ul style="list-style-type: none"> • Fastest cut rate even on hard-to-sand surfaces • Extended life – up to 2:1 over conventional discs • Broadest ceramic grit range available
<ul style="list-style-type: none"> • Full resin bond system 	<ul style="list-style-type: none"> • Improved grain adhesion and longest disc life
<ul style="list-style-type: none"> • Unique fiber-reinforced, flexible B- and C-weight latex-saturated backing 	<ul style="list-style-type: none"> • 50% - 60% improvement in tear resistance, superior resistance to delamination • Durable, yet flexible
<ul style="list-style-type: none"> • Special undyed stearate oversize 	<ul style="list-style-type: none"> • Superior load resistance • No color transfer to work
<ul style="list-style-type: none"> • Hook and loop fastening system 	<ul style="list-style-type: none"> • Neat, clean application and removal • Can be re-used
<ul style="list-style-type: none"> • Laser perforated every 2-3/4" 	<ul style="list-style-type: none"> • Easy tearing into multiple popular lengths

PART #	GRADING	ROLLS/PKG.	ROLLS/CASE
2-3/4" x 13 YARDS			
05539599570	P80 C 2312 DO	1	4
05539599568	P120 C 2312 DO	1	4
05539599567	P150 B 2312 DO	1	4
05539599566	P180 B 2312 DO	1	4
05539599565	P220 B 2312 DO	1	4
05539599564	P320 B 2312 DO	1	4
05539599590	P400 B 2312 DO	1	4
05539599591	P500 B 2312 DO	1	4
05539599592	P600 B 2312 DO	1	4



MERIT GRIP-ON PAPER ROLLS
 Good Tier / Aluminum Oxide Dri-Lube Resin Paper Open

PB273



Good choice for sanding paints, primers, plastics, and fiberglass, as well as whitewood sanding, clean-up, and repair – at a low initial price.

FEATURES	BENEFITS
<ul style="list-style-type: none"> • P-graded, sharp, light-brown aluminum oxide abrasive 	<ul style="list-style-type: none"> • Fast cut rate, extended life, and consistent finish
<ul style="list-style-type: none"> • Full resin bond system 	<ul style="list-style-type: none"> • Improved grain adhesion and longest life
<ul style="list-style-type: none"> • Premium B-weight latex-saturated, high-internal-bond paper backing 	<ul style="list-style-type: none"> • Improved resistance to delamination
<ul style="list-style-type: none"> • Water-based stearate anti-loading oversize and an open coat 	<ul style="list-style-type: none"> • Improved load resistance on a broad range of substrates
<ul style="list-style-type: none"> • No pigment in anti-load oversize or bond 	<ul style="list-style-type: none"> • No risk of color transfer, stronger bond
<ul style="list-style-type: none"> • Hook and loop fastening system 	<ul style="list-style-type: none"> • Neat, clean application and removal

PART #	GRADING	ROLLS/PKG.	ROLLS/CASE
3" x 12 YARDS			
66623345609	P80 PB273	1	4
66623334493	P120 PB273	1	4
66623334494	P150 PB273	1	4
66623334495	P180 PB273	1	4
66623345611	P220 PB273	1	4
66623335601	P320 PB273	1	4
66623345612	P400 PB273	1	4



PREMIER RED STICK-ON PAPER ROLLS
Better Tier / Aluminum Oxide Dri-Lube Resin Paper Open



Best choice for paints, primers, plastics, fiberglass, wood and sealer sanding.

FEATURES	BENEFITS
• P-graded, heat-treated, aluminum oxide abrasive	• Consistent scratch pattern and finish
• Full resin bond system	• Improved grain adhesion and longest life
• Unique fiber-reinforced, B-weight, latex-saturated backing	• 50% – 60% improvement in tear strength, superior resistance to delamination
• PSA (pressure sensitive adhesive) backing	• Easy application and removal
• Special, undyed stearate oversize and an open coat	• Superior load resistance • No color transfer to work

PART #	GRADING	ROLLS/PKG.	ROLLS/CASE
2-3/4" x 25 YARDS			
05539520340	P80 B 0912 DO	1	5
2-3/4" x 30 YARDS			
05539520339	P100 B 0912 DO	1	5
05539520338	P120 B 0912 DO	1	5
2-3/4" x 45 YARDS			
05539520337	P150 B 0912 DO	1	5
05539520336	P180 B 0912 DO	1	5
05539520335	P220 B 0912 DO	1	5
05539520334	P240 B 0912 DO	1	5
05539520333	P320 B 0912 DO	1	5
05539520332	P400 B 0912 DO	1	5

PART #	GRADING	ROLLS/PKG.	ROLLS/CASE
4-1/2" x 10 YARDS			
05539561116	P80 B 0912 DO	1	5
05539561114	P120 B 0912 DO	1	5
05539561113	P150 B 0912 DO	1	5
05539561112	P180 B 0912 DO	1	5
05539561111	P220 B 0912 DO	1	5



CARBO GOLD STICK-ON PAPER ROLLS
Good Tier / Aluminum Oxide Dri-Lube Resin Paper Open



Ideal for sanding paints, primers, plastics and fiberglass as well as whitewood sanding, clean-up and repair.

FEATURES	BENEFITS
• Premium, P-graded, light brown aluminum oxide abrasive	• Fast cut, long life
• Durable, C-weight backing	• High tear resistance
• PSA (pressure sensitive adhesive) backing	• Easy application and removal
• Special, water-based stearate oversize and an open coat	• Excellent load resistance

PART #	GRADING	ROLLS/PKG.	ROLLS/CASE
2-3/4" x 20 YARDS			
05539570528	P80 C 0712 DO	1	5

PART #	GRADING	ROLLS/PKG.	ROLLS/CASE
2-3/4" x 25 YARDS			
05539570527	P150 C 0712 DO	1	5
05539570526	P180 C 0712 DO	1	5
05539570525	P220 C 0712 DO	1	5
05539570524	P320 C 0712 DO	1	5
05539570523	P400 C 0712 DO	1	5



DISPENSER FOR STICK-ON ROLLS



This portable Stick-On roll dispenser is a convenient way to unwind the rolls and tear to the desired length. It can be used with all 2-3/4" PSA Stick-On rolls.

PART #	DESCRIPTION	DISPENSERS/CASE
STICK-ON ROLL DISPENSER		
05539520523	Stick-On Roll Dispenser	1



PAPER SHEET COMPETITIVE CROSS REFERENCE

CARBORUNDUM	3M	HERMES	KLINGSPOR	MIRKA	SIA	VSM
A 0311 O	110N	–	–	–	–	–
A 0811 O	210N, 210U	HFB	PL31	–	–	–
BF 0415 W	401Q	WSFlex18B	PS11	Waterproof (A)	–	CP918A
BF 0416 W	413Q	WSFlex18B	PS11	Waterproof (A)	–	CP918A
B 0412 DO	414N, 415N, 415U, 426U	PSF-LL, SA168	PL35	CaratFlex, FineFlex	1748	CP131A
B 0912 DO, B 0712 DO	214U, 216U, 334U, 734U	HC133, HCAB	PS33	Royal, Royal Micro	1950 Siaspeed	–
BF 0916 W, BF 0716 W	213Q	–	PS12	–	–	–
C 0311 O	130N	GCAB	–	–	–	–
C 0414 W	438Q, 431Q	WSFlex18C	PS11	–	–	CP918C
C 0811 O	230N	HFB	PL31	–	–	KP31B
D 0311 O	140N	GCAB	–	–	–	–
D 0811 O	230U, 240N, 346U	–	–	–	–	KP31C

PAPER SHEET STARTING RECOMMENDATIONS BY MATERIAL/APPLICATION

MATERIAL	BEST PERFORMANCE	GENERAL DUTY
Unfinished Metal	B 0912 DO / B 0712 DO	D 0811 O, C 0811 O, A 0811 O, PB273
Primed and Painted Surfaces	B 0912 DO / B 0712 DO	D 0811 O, C 0811 O, A 0811 O, PB273
Fiberglass / Composites	B 0912 DO / B 0712 DO	PB273
Bare Wood	B 0912 DO / B 0712 DO	A 0311 O, C 0311 O, D 0311 O, D 0811 O, C 0811 O, A 0811 O
Clear Coat Sanding	BF 0415 W	–
Sealer Sanding	B 0912 DO / B 0712 DO	B 0412 DO, PB273
Lacquer Sanding	BF 0415 W, BF 0416 W	C 0414 W, B 0912 DO / B 0712 DO, BF 0916 W
Wet Sanding	BF 0415 W, BF 0416 W	C 0414 W, B 0912 DO / B 0712 DO, BF 0916 W
Paint Stripping	B 0912 DO / B 0712 DO	–

CLOTH SHEET COMPETITIVE CROSS REFERENCE

CARBORUNDUM	3M	HERMES	KLINGSPOR	SIA	VSM
JC 0250	011K Crystal Bay	–	KL371	C680J	–
XC 0851	311T Three-M-lte BG, 211K Electrocut	RB317LX	CS310X	–	KK504X
JCF 0852	211K Three-M-lte, 311K Three-M-lte	RB232J	KL361	2947J	KK504J KK504X
M 0405 W	481W	–	–	–	–

CLOTH SHEET STARTING RECOMMENDATIONS

CUT RATE	FINISH	SPEC
Waterproof	Load Resistant	M 0405 W
Fast Cut	General Finish	JCF 0852
Slow Cut	Fine Finish	JC 0250

PREMIER RED PAPER SHEETS

Best Tier / Aluminum Oxide Dri-Lube Resin Paper Open

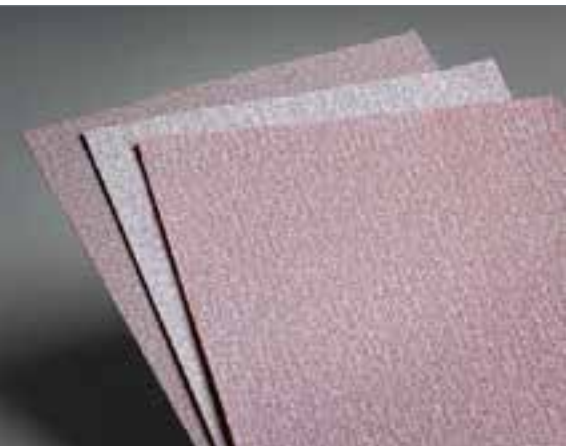

Ultimate choice for machine and hand sanding of paints, primers, light metals and basecoat/clearcoat paints.

FEATURES	BENEFITS
<ul style="list-style-type: none"> P-graded, heat-treated, aluminum oxide abrasive 	<ul style="list-style-type: none"> Consistent finish without a deep scratch 30% to 50% faster cut rate than conventional aluminum oxide sheets
<ul style="list-style-type: none"> Full resin bond system 	<ul style="list-style-type: none"> Improved grain adhesion and longest life
<ul style="list-style-type: none"> Unique fiber-reinforced, B-weight, latex-saturated backing 	<ul style="list-style-type: none"> 50% – 60% improvement in tear strength, superior resistance to delamination Durable, yet flexible
<ul style="list-style-type: none"> Special, undyed stearate oversize and an open coat 	<ul style="list-style-type: none"> Superior load resistance and extended life No color transfer to work

PART #	GRADING		SHEETS/PKG.	SHEETS/CASE
9" x 11"				
05539520538	P80	B 0912 DO	50	250
05539520537	P100	B 0912 DO	100	500
05539520536	P120	B 0912 DO	100	500
05539520535	P150	B 0912 DO	100	500
05539520534	P180	B 0912 DO	100	500
05539520533	P220	B 0912 DO	100	500
05539520532	P240	B 0912 DO	100	500
05539520531	P280	B 0912 DO	100	500
05539520530	P320	B 0912 DO	100	500
05539520529	P400	B 0912 DO	100	500

PART #	GRADING		SHEETS/PKG.	SHEETS/CASE
9" x 11" (CONTINUED)				
05539563785	P500	B 0912 DO	100	500
05539520528	P600	B 0912 DO	100	500
05539514148	P800	B 0712 DO	100	500
05539520527	P1000	B 0712 DO	100	500
05539520526	P1200	B 0712 DO	100	500



MERIT PB273 PAPER SHEETS

Good Tier / Aluminum Oxide Dri-Lube Resin Paper Open



Good choice for sanding paint, primer, plastics, and fiberglass, as well as whitewood sanding, clean-up, and repair – at a low initial price.

FEATURES	BENEFITS
<ul style="list-style-type: none"> P-graded, sharp, light-brown aluminum oxide abrasive 	<ul style="list-style-type: none"> Fast cut rate, extended life, and consistent finish
<ul style="list-style-type: none"> Full resin bond system 	<ul style="list-style-type: none"> Improved grain adhesion and longest life
<ul style="list-style-type: none"> Premium B-weight latex-saturated, high-internal-bond paper backing 	<ul style="list-style-type: none"> Improved resistance to delamination
<ul style="list-style-type: none"> Water-based stearate anti-loading oversize and an open coat 	<ul style="list-style-type: none"> Improved load resistance on a broad range of substrates
<ul style="list-style-type: none"> No pigment in anti-load oversize or bond 	<ul style="list-style-type: none"> No risk of color transfer, stronger bond

PART #	GRADING		SHEETS/PKG.	SHEETS/CASE
9" x 11"				
66623311878	P80	PB273	50	250
66623311877	P100	PB273	100	500
66623311876	P120	PB273	100	500
66623311875	P150	PB273	100	500
66623311874	P180	PB273	100	500
66623311873	P220	PB273	100	500
66623311879	P240	PB273	100	500
66623311871	P320	PB273	100	500
66623311870	P400	PB273	100	500



SILICON CARBIDE PAPER SHEETS

Better Tier / Silicon Carbide Dri-Lube Resin Paper Open

CARBO™



For hand and machine sanding paint and primer, as well as whitewood clean-up and sealer sanding.

FEATURES	BENEFITS
• P-graded silicon carbide abrasive	• Sharp cut, excellent finish
• Full resin bond system	• Improved grain adhesion and longest life
• Flexible B-weight latex-saturated paper	• Increased flexibility and tear strength
• Stearate oversize	• Improved load resistance

PART #	GRADING		SHEETS/PKG.	SHEETS/CASE
9" x 11"				
05539510819	80	B 0412 DO	50	250
05539510818	100	B 0412 DO	100	500
05539510817	120	B 0412 DO	100	500
05539510816	150	B 0412 DO	100	500
05539510815	180	B 0412 DO	100	500
05539510814	220	B 0412 DO	100	500
05539510813	240	B 0412 DO	100	500
05539510812	280	B 0412 DO	100	500
05539510810	320	B 0412 DO	100	500
05539510808	400	B 0412 DO	100	500



PREMIER RED MIRROR FINISH PAPER SHEETS

Best Tier / Aluminum Oxide Resin Waterproof Paper

CARBO™
MIRROR
finish™



Ideal for removing surface imperfections in acrylic lacquers, enamels, urethanes and clearcoats. Use wet for best results.

FEATURES	BENEFITS
• Premium, P-graded, heat-treated aluminum oxide abrasive	• Ultimate cut and life in wet applications
• Strong, resin bond system	• Long life in wet applications
• B-weight, high-latex, waterproof paper backing	• Ultimate flexibility
	• Wet-curl resistance
	• Environmentally stable, resists humidity-caused curling

PART #	GRADING		SHEETS/PKG.	SHEETS/CASE
9" x 11"				
05539563888	P220	BF 0916 W	5	250
05539563887	P240	BF 0916 W	5	250
05539563885	P320	BF 0916 W	5	250
05539563884	P400	BF 0916 W	5	250
05539563883	P500	BF 0916 W	5	250
05539563882	P600	BF 0916 W	5	250
05539563881	P800	BF 0716 W	5	250



PREMIER RED MIRROR FINISH PAPER SHEETS

Best Tier / Silicon Carbide Resin Waterproof Paper



Ideal for producing very fine finishes in wet applications.

FEATURES	BENEFITS
<ul style="list-style-type: none"> Premium, ultra fine (1000-2000 grits), silicon carbide abrasive 	<ul style="list-style-type: none"> Ultimate finish in wet applications Higher cut rate and improved life
<ul style="list-style-type: none"> Full resin bond 	<ul style="list-style-type: none"> Longer life in wet applications
<ul style="list-style-type: none"> Extremely flexible B-weight waterproof paper backing 	<ul style="list-style-type: none"> Much improved wet-curl resistance Environmentally stable; resists humidity-caused curling

PART #	GRADING		SHEETS/PKG.	SHEETS/CASE
9" x 11"				
05539563880	1000	BF 0415 W	50	250
05539563879	1200	BF 0415 W	50	250
05539563878	1500	BF 0415 W	50	250
05539563877	2000	BF 0415 W	50	250



SILICON CARBIDE PAPER SHEETS

Better Tier / Silicon Carbide Resin Waterproof Paper



Exceptional finishing in wet applications.

FEATURES	BENEFITS
<ul style="list-style-type: none"> Sharp, strong silicon carbide abrasive 	<ul style="list-style-type: none"> Exceptional finishes in wet applications
<ul style="list-style-type: none"> Full resin bond 	<ul style="list-style-type: none"> Longer life in wet applications
<ul style="list-style-type: none"> Extremely flexible, B-weight waterproof paper backing 	<ul style="list-style-type: none"> Improved wet-curl resistance Environmentally stable: resists humidity-caused curling

PART #	GRADING		SHEETS/PKG.	SHEETS/CASE
9" x 11"				
05539563866	220	BF 0416 W	50	250
05539563865	240	BF 0416 W	50	250
05539563864	280	BF 0416 W	50	250
05539563863	320	BF 0416 W	50	250
05539563862	360	BF 0416 W	50	250
05539563861	400	BF 0416 W	50	250
05539563860	500	BF 0416 W	50	250
05539563859	600	BF 0416 W	50	250



SILICON CARBIDE PAPER SHEETS

Good Tier / Silicon Carbide Resin Waterproof Paper



May be used wet or dry on plastic or painted surfaces. Best results are obtained when used wet. Excellent for machine and hand rubbing of lacquer, urethane and varathane between coats. Ideal for obtaining fine finishes and feather-edging painted surfaces.

FEATURES	BENEFITS
<ul style="list-style-type: none"> Silicon carbide abrasive 	<ul style="list-style-type: none"> Ideal for finish sanding
<ul style="list-style-type: none"> Resin bond 	<ul style="list-style-type: none"> Excellent grain adhesion
<ul style="list-style-type: none"> Strong waterproof paper backing 	<ul style="list-style-type: none"> Resistance to deterioration when used wet

PART #	GRADING		SHEETS/PKG.	SHEETS/CASE
9" x 11"				
05539510798	60	C 0414 W	50	250
05539510797	80	C 0414 W	50	250
05539510796	100	C 0414 W	50	250
05539510795	120	C 0414 W	50	250
05539510794	150	C 0414 W	50	250
05539510793	180	C 0414 W	50	250



ALUMINUM OXIDE PAPER SHEETS

Good Tier / Aluminum Oxide Paper Open

CARBO™



Ideal for general-duty dry sanding of paint, primers, light metals and woods.

FEATURES	BENEFITS
<ul style="list-style-type: none"> P-graded, aluminum oxide abrasive 	<ul style="list-style-type: none"> Tough and durable

PART #	GRADING		SHEETS/PKG.	SHEETS/CASE
9" x 11"				
05539510876	P36	D 0811 O	25	125
05539510875	P40	D 0811 O	25	125
05539510874	P50	D 0811 O	50	250
05539510873	P60	C 0811 O	50	250
05539510872	P80	C 0811 O	50	250
05539510871	P100	C 0811 O	100	500
05539510870	P120	C 0811 O	100	500
05539510868	P150	C 0811 O	100	500
05539510862	P180	A 0811 O	100	500
05539510861	P220	A 0811 O	100	500



GARNET PAPER SHEETS

Good Tier / Garnet Paper Open

CARBO™



For hand and machine sanding of whitewood.

FEATURES	BENEFITS
<ul style="list-style-type: none"> Natural garnet abrasive Unique bond system 	<ul style="list-style-type: none"> Sharp and consistent cutting action Durable

PART #	GRADING		SHEETS/PKG.	SHEETS/CASE
9" x 11"				
05539510854	50	D 0311 O	50	250*
05539510853	60	C 0311 O	50	250
05539510852	80	C 0311 O	50	250
05539510851	100	C 0311 O	100	500
05539510850	120	C 0311 O	100	500
05539510849	150	C 0311 O	100	500
05539510848	80	A 0311 O	50	250
05539510847	100	A 0311 O	100	500
05539510846	120	A 0311 O	100	500
05539510845	150	A 0311 O	100	500
05539510844	180	A 0311 O	100	500
05539510843	220	A 0311 O	100	500



EMERY CLOTH SHEETS

Good Tier / Emery Cloth

CARBO™



Used for removing light burrs and cleaning and polishing metals. May be used dry or with oil.

FEATURES	BENEFITS
<ul style="list-style-type: none"> Natural emery abrasive Flexible, cotton backing 	<ul style="list-style-type: none"> Soft by nature, for light abrading and sanding Follows shapes and contours

PART #	GRADING		SHEETS/PKG.	SHEETS/CASE
9" x 11"				
05539510887	Coarse	JC 0250	25	125
05539510886	Medium	JC 0250	50	250
05539510885	Fine	JC 0250	50	250



ALUMINUM OXIDE CLOTH SHEETS

Good Tier / Aluminum Oxide Resin Cloth

CARBO™



Ideal for hand sanding, deburring, polishing and removing cutting tool marks on all metal parts.

FEATURES	BENEFITS
• P-graded, aluminum oxide abrasive	• Tough and durable
• Advanced full resin bond system	• Exceptional grain adhesion for long life
• JCF 0852: orange, J-weight backing with increased flexibility	• Superior conformability to complex surfaces and better finishes

PART #	GRADING		SHEETS/PKG.	SHEETS/CASE
9" x 11"				
05539510988	P40	XC 0851	25	125
05539511103	P50	XC 0851	25	125
05539511143	P60	XC 0851	25	125
05539529361	P80	JCF 0852	25	125
05539529360	P100	JCF 0852	50	250
05539529359	P120	JCF 0852	50	250
05539529358	P150	JCF 0852	50	250
05539529357	P180	JCF 0852	50	250
05539529356	P220	JCF 0852	50	250
05539529355	P240	JCF 0852	50	250
05539529354	P280	JCF 0852	50	250
05539529353	P320	JCF 0852	50	250
05539529352	P400	JCF 0852	50	250
05539563813	P500	JCF 0851	50	250
05539529351	P600	JCF 0852	50	250



SILICON CARBIDE SANDSCREEN SHEETS

Good Tier / Silicon Carbide Waterproof Resin Sandscreen

CARBO™

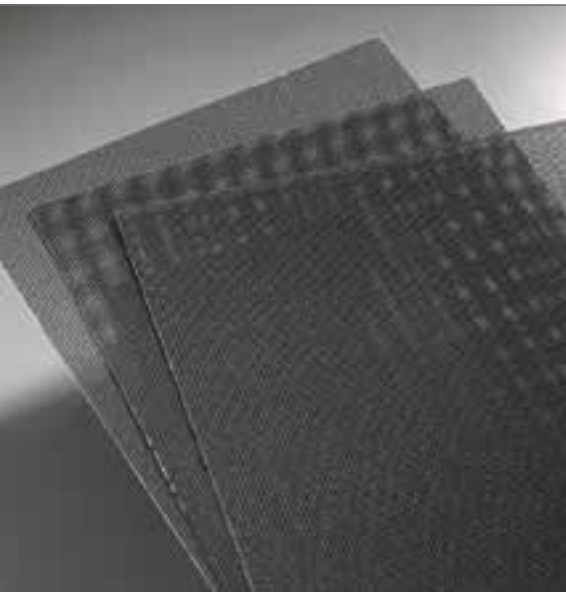

Ideally suited for floorsanding, drywall, ceramics and wet deck sanding. May be used wet or dry.

FEATURES	BENEFITS
• Black, silicon carbide abrasive	• Very sharp and hard, but brittle
• P-graded in 220 and coarser grits	• Provides consistent finishes
• Full resin bond system	• Maximum grain adhesion
• Screen backing	• Load resistant
	• Both sides are usable

PART #	GRADING		SHEETS/PKG.	SHEETS/CASE
9" x 11"				
05539512316	P80	M 0405 W	25	125
05539512315	P100	M 0405 W	25	125
05539512314	P120	M 0405 W	25	125
05539512313	P150	M 0405 W	25	125
05539512312	P180	M 0405 W	25	125
05539512310	P220	M 0405 W	25	125
05539512308	320	M 0405 W	25	125
05539512307	400	M 0405 W	25	125



TechTip

Use light machine oil with cloth sheets as a lubricant for finer finishes and quicker cut.



It is the user's responsibility to refer to and comply with ANSI B7.7



PREMIER RED STICK-ON MARINE FILE STRIPS

Better Tier / Zirconia Alumina Resin Paper Open



Best choice for blending and shaping all types of marine fillers.

FEATURES		BENEFITS	
• Premium zirconia alumina abrasive	• Full phenolic resin bond system plus latex	• Fast removal rates	• Extended life
• E-weight, latex paper backing	• PSA (pressure sensitive adhesive) backing	• Maximum durability plus flexibility	• Excellent grain adhesion
		• Reduced edge shed	• Flexible
		• Easy application and removal	

PART #	GRADING		STRIPS/PKG.	STRIPS/CASE
2-3/4" x 16-1/2"				
05539521338	36	E 1214 0	50	250
05539521337	40	E 1214 0	50	250
05539521336	80	E 1214 0	50	250

For use with File Board #05539512013 on page 79.



PREMIER RED VACUUM STICK-ON MARINE FILE STRIPS

Better Tier / Zirconia Alumina Resin Paper Open



Best choice for blending and shaping all types of marine fillers.

FEATURES		BENEFITS	
• Premium zirconia alumina abrasive	• Full phenolic resin bond system plus latex	• Fast removal rates	• Extended life
• E-weight, latex paper backing	• PSA backing	• Maximum durability plus flexibility	• Excellent grain adhesion
• Vacuum holes		• Reduced edge shed	• Flexible
		• Easy application and removal	• Dust-free sanding environment

PART #	GRADING		STRIPS/PKG.	STRIPS/CASE
2-3/4" x 16" VACUUM D-3364				
05539521339	80	E 1214 0	50	250

Die 3364: 0.5" diameter holes; 9 sets of 2 holes on either side of strip, spaced equally from center at 1.750" apart (14" total)



PREMIER RED GRIP-ON MARINE FILE STRIPS

Better Tier / Zirconia Alumina Resin Paper Open



Best choice for blending and shaping all types of marine fillers.

FEATURES	BENEFITS
<ul style="list-style-type: none"> Premium zirconia alumina abrasive Full phenolic resin bond system plus latex 	<ul style="list-style-type: none"> Fast removal rates with extended life Maximum durability plus flexibility Excellent grain adhesion
<ul style="list-style-type: none"> E-weight, latex paper backing Hook and loop fastening system 	<ul style="list-style-type: none"> Flexible; reduced edge shed Easy application and removal; can be re-used

PART #	GRADING	STRIPS/PKG.	STRIPS/CASE
2-3/4" x 16-1/2"			
05539521344	36 E 1214 O	25	125
05539521343	40 E 1214 O	25	125
05539521342	80 E 1214 O	25	125

For use with File Board 05539512014 and File Shoe 05539512015 on page 79.



PREMIER RED GRIP-ON MARINE FILE STRIPS

Better Tier / Aluminum Oxide Dri-Lube Resin Paper Open



Blending all paints, primers, plastics and fiberglass.

FEATURES	BENEFITS
<ul style="list-style-type: none"> P-graded, heat-treated, aluminum oxide abrasive Full resin bond system Unique, fiber-reinforced, B-weight paper backing Hook and loop fastening system Special, undyed stearate oversize and an open coat 	<ul style="list-style-type: none"> 30% to 50% faster cut rate than other strips Consistent scratch pattern and finish Improved grain adhesion; longest life 50% – 60% improvement in tear strength Superior resistance to delamination Easy application and removal; can be re-used Superior load resistance No color transfer to work

PART #	GRADING	STRIPS/PKG.	STRIPS/CASE
2-3/4" x 16-1/2"			
05539520475	P80 B 0912 DO	50	500
05539520474	P100 B 0912 DO	50	500
05539520473	P120 B 0912 DO	50	500
05539520472	P150 B 0912 DO	50	500
05539520471	P180 B 0912 DO	50	500
05539520470	P220 B 0912 DO	50	500

For use with File Board 05539512014 and File Shoe 05539512015 on page 79.



PREMIER RED VACUUM GRIP-ON MARINE FILE STRIPS

Better Tier / Zirconia Alumina Resin Paper Open



Best choice for blending and shaping all types of marine fillers.

FEATURES	BENEFITS
<ul style="list-style-type: none"> Premium zirconia alumina abrasive Full phenolic resin bond system plus latex 	<ul style="list-style-type: none"> Fast removal rates with extended life Maximum durability plus flexibility Excellent grain adhesion
<ul style="list-style-type: none"> E-weight, latex paper backing Hook and loop fastening system Vacuum holes 	<ul style="list-style-type: none"> Flexible; reduced edge shed Easy application and removal; can be re-used Dust-free sanding environment

PART #	GRADING	STRIPS/PKG.	STRIPS/CASE
2-3/4" x 16" VACUUM D-3364			
05539521345	80 E 1214 O	25	125

Die 3364: 0.5" diameter holes; 9 sets of 2 holes on either side of strip, spaced equally from center at 1.750" apart (14" total)



PREMIER RED CLIP-ON MARINE FILE STRIPS

Better Tier / Zirconia Alumina Resin Paper Open



Best choice for blending and shaping all types of marine fillers.

FEATURES	BENEFITS
<ul style="list-style-type: none"> Premium zirconia alumina abrasive 	<ul style="list-style-type: none"> Fast removal rates Extended life
<ul style="list-style-type: none"> Full phenolic resin bond system plus latex 	<ul style="list-style-type: none"> Maximum durability plus flexibility Excellent grain adhesion
<ul style="list-style-type: none"> E-weight, latex paper backing 	<ul style="list-style-type: none"> Flexible ; reduced edge shed

PART #	GRADING	STRIPS/PKG.	STRIPS/CASE
2-3/4" x 17-1/2"			
05539521350	36 E 1214 O	50	250
05539521349	40 E 1214 O	50	250
05539521348	80 E 1214 O	50	250

For use with File Board #05539512013 on page 79.



ALUMINUM OXIDE CLIP-ON MARINE FILE STRIPS

Good Tier / Aluminum Oxide Paper Open



For blending and shaping of marine filler.

FEATURES	BENEFITS
<ul style="list-style-type: none"> P-graded, brown aluminum oxide abrasive 	<ul style="list-style-type: none"> Tough and durable

PART #	GRADING	STRIPS/PKG.	STRIPS/CASE
2-3/4" x 17-1/2"			
05539510908	P36 D 0811 O	50	500
05539510907	P40 D 0811 O	50	500
05539510906	P60 C 0811 O	50	500
05539510905	P80 C 0811 O	50	500
05539510904	P100 C 0811 O	50	500

For use with File Board #05539512013 on page 79.



CARBO GOLD CLIP-ON MARINE FILE STRIPS

Good Tier / Aluminum Oxide Dri-Lube Resin Paper Open



Ideal for blending and shaping all types of marine fillers.

FEATURES	BENEFITS
<ul style="list-style-type: none"> P-graded, light brown aluminum oxide abrasive 	<ul style="list-style-type: none"> Fast, aggressive cut and long life
<ul style="list-style-type: none"> C-weight paper backing 	<ul style="list-style-type: none"> Durability plus tear resistance
<ul style="list-style-type: none"> Waterbased stearate oversize and an open coat 	<ul style="list-style-type: none"> Excellent load resistance

PART #	GRADING	STRIPS/PKG.	STRIPS/CASE
2-3/4" x 17-1/2"			
05539510903	P80 C 0712 DO	50	500
05539510902	P100 C 0712 DO	50	500
05539510900	P120 C 0712 DO	50	500
05539510899	P150 C 0712 DO	50	500
05539510898	P180 C 0712 DO	50	500

For use with File Board #05539512013 on page 79.



HAND MARINE FILE BOARD

Accessory



Sturdy tool for hand sanding and blending marine filler. Can be used with both Clip-On and Stick-On marine file strips.

PART #	DESCRIPTION	FILE BOARDS/PKG.
HAND MARINE FILE BOARD		
05539512013	Hand File Board	6

GRIP-ON MARINE FILE BOARD

Accessory



Sturdy tool for hand sanding and blending marine filler. Incorporates a unique hook and loop fastening system. For use with Grip-On marine file strips.

PART #	DESCRIPTION	FILE BOARDS/PKG.
GRIP-ON MARINE FILE BOARD		
05539512014	2-3/4" x 16-1/2"	5

GRIP-ON MARINE AIR FILE SHOE

Accessory



For use on orbital air sanders. Grip-On feature eliminates the need for clips, making mounting and removal quick and easy.

PART #	DESCRIPTION	FILE BOARDS/PKG.
GRIP-ON MARINE AIR FILE SHOE		
05539512015	2-3/4" x 16-1/2"	1

EZTOUCH ABRASIVE CONTOUR SPONGES

Better Tier / Aluminum Oxide or Silicon Carbide

CARBO™
ez TOUCH™



For hand sanding and uniform finishing of wood, metal, fiberglass, composites, plastics and solid surfaces, and primed, stained, sealed or painted surfaces.

FEATURES

- Thin, coated on one side with aluminum oxide or silicon carbide abrasive
- Designed with superior flexibility

BENEFITS

- Can be used wet or dry; washable
- Ideal for flat, curved, contoured and hard-to-reach areas

PART #	GRADING	SPONGES/CASE
4-1/2" x 5-1/2" x 3/16" – ONE SIDED		
05539570121	60 Medium Aluminum Oxide	80
05539570122	100 Fine Aluminum Oxide	80
05539570123	180 Super Fine Aluminum Oxide	80
05539570124	220 Ultra Fine Silicon Carbide	80
05539570125	280 Micro Fine Silicon Carbide	80



FLEXIBLE ABRASIVE SANDING SPONGES

Standard Tier / Silicon Carbide

CARBO™

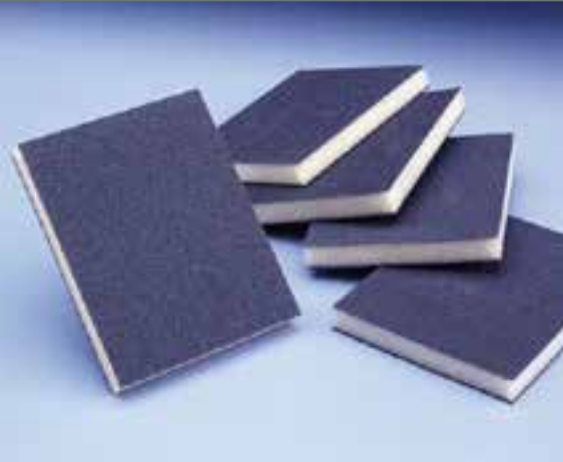

Ideal for sanding sealer and wash coats in wood, and touching-up or repairing of primer.

FEATURES

- Ultra flexible polyurethane foam
- Silicon carbide grain

BENEFITS



- Provides for a soft sanding action on flat and contoured surfaces without sanding through coatings
- The best choice for sanding primer, sealer and between coats of finish on furniture and cabinets

PART #	GRADING	SPONGES/CASE
4-3/4" x 3-3/4" x 1/2" – TWO SIDED		
05539513710	100 Coarse Silicon Carbide	250
05539513711	150 Medium Silicon Carbide	250
05539513712	220 Fine Silicon Carbide	250



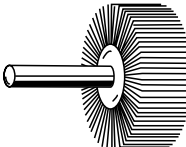

SHAPE RECOMMENDATION GUIDE

SHAPE	DESCRIPTION/APPLICATION
	<p>Flap Wheels with Mounted Steel Shanks</p> <p>Wheels are designed with a 1/8" or 1/4" steel shank as an integral part of each wheel. These shanks run through the wheel creating better balance, a reduction of chatter, and reduced operator fatigue. They also permit quick changes on air tools when using other abrasive products.</p>
	<p>Flap Wheels with Mounted 1/4-20 Thread</p> <p>Wheels are designed with a 1/4"-20 thread and flange as an integral part of the wheel. These threads facilitate the quickest changes on air tools using flap wheels exclusively, as there are no special tools needed to change the flap wheel. Also allow extended reach with accessory mandrels.</p>
	<p>Flap Wheels with Arbor Holes</p> <p>For use on larger portable and fixed-base tools where the wheel must fit on an existing arbor.</p>

Good Tier / Aluminum Oxide



Good choice when initial price is the main consideration. The smallest flap wheels, ranging from 3/8" to 1-3/16" diameter, mounted on a 1/8" diameter steel shank. Provide fast polishing and light deburring of internal workpieces with holes or grooves as small as 1/2".

FEATURES	BENEFITS
• Quality aluminum oxide abrasive	• Good cut rate and life
• Engineered cotton backing	• Longer life and wear resistance
• Low initial price point	• Best starting specification for end-user unable to measure total performance

PART #	GRIT	MAX. RPM	STD. PKG.
3/8" x 3/8" x 1/8"			
08834137470	60	40,000	10
08834137471	80	40,000	10
08834137472	120	40,000	10
08834137473	180	40,000	10
08834137474	240	40,000	10
08834137475	320	40,000	10
5/8" x 5/8" x 1/8"			
08834137480	60	37,000	10
08834137481	80	37,000	10
08834137482	120	37,000	10
08834137483	180	37,000	10
08834137484	240	37,000	10
08834137485	320	37,000	10
5/8" x 3/4" x 1/8"			
08834137541	80	37,000	10
08834137542	120	37,000	10
08834137543	180	37,000	10
08834137544	240	37,000	10
08834137545	320	37,000	10
3/4" x 3/16" x 1/8"			
08834137551	80	35,000	10
08834137552	120	35,000	10
08834137553	180	35,000	10
3/4" x 3/8" x 1/8"			
08834137561	80	35,000	10
08834137562	120	35,000	10
08834137563	180	35,000	10
3/4" x 1/2" x 1/8"			
08834137571	80	35,000	10
08834137572	120	35,000	10
08834137573	180	35,000	10
08834137574	240	35,000	10
08834137575	320	35,000	10

PART #	GRIT	MAX. RPM	STD. PKG.
3/4" x 5/8" x 1/8"			
08834137580	60	35,000	10
08834137581	80	35,000	10
08834137582	120	35,000	10
08834137583	180	35,000	10
08834137584	240	35,000	10
08834137585	320	35,000	10
3/4" x 3/4" x 1/8"			
08834137590	60	35,000	10
08834137591	80	35,000	10
08834137592	120	35,000	10
08834137594	240	35,000	10
08834137595	320	35,000	10
1-3/16" x 1/8" x 1/8"			
08834137491	80	30,000	10
08834137492	120	30,000	10
08834137493	180	30,000	10
08834137495	320	30,000	10
1-3/16" x 3/16" x 1/8"			
08834137508	60	30,000	10
08834137501	80	30,000	10
08834137502	120	30,000	10
08834137503	180	30,000	10
08834137504	240	30,000	10
08834137505	320	30,000	10
1-3/16" x 3/8" x 1/8"			
08834137511	80	30,000	10
08834137512	120	30,000	10
08834137513	180	30,000	10
08834137514	240	30,000	10
08834137515	320	30,000	10



MICRO-MINI TEST KIT "MMC"



Contains a variety of the most popular shapes and sizes.

PART #	DESCRIPTION	STD. PKG.
08834131493	Includes five wheels, 3/8" to 1-3/16" diameter in various grits, mounted on 1/8" diameter hardened steel shanks	1

MERIT HIGH PERFORMANCE MINI FLAP WHEELS 1/4" MOUNTED STEEL SHANKS



Best Tier / Ceramic Alumina/Aluminum Oxide Blend



Best choice for more durable flap wheel applications where aggressive cut and superior life are required.

FEATURES	BENEFITS
<ul style="list-style-type: none"> Long-lasting ceramic alumina/aluminum oxide abrasive grain blend Heavy cotton backing 	<ul style="list-style-type: none"> Aggressive cut and 2 to 3 times longer life Extended durability for added life and reduced edge wear

PART #	GRIT	MAX. RPM	STD. PKG.
1" x 5/8" x 1/4"			
08834137105	40	30,000	10
08834137100	60	30,000	10
08834137101	80	30,000	10
08834137102	120	30,000	10
08834131536	180	30,000	10
08834137104	240	30,000	10
1" x 1" x 1/4"			
08834131259	40	30,000	10
08834137310	60	30,000	10
08834137311	80	30,000	10
08834137312	120	30,000	10
08834137313	180	30,000	10
08834137114	240	30,000	10
08834137315	320	30,000	10
1-3/8" x 5/8" x 1/4"			
08834137320	60	30,000	10
08834137321	80	30,000	10
08834137322	120	30,000	10
08834137323	180	30,000	10
1-1/2" x 1" x 1/4"			
08834135140	40	25,000	10
08834137340	60	25,000	10
08834137141	80	25,000	10
08834137142	120	25,000	10
08834137343	180	25,000	10
08834132101	240	25,000	10
1-1/2" x 1-1/2" x 1/4"			
08834130643	60	25,000	10
08834130644	80	25,000	10
2" x 3/4" x 1/4"			
08834137160	60	25,000	10
08834137161	80	25,000	10
08834137162	120	25,000	10
2" x 1" x 1/4"			
08834137377	40	25,000	10
08834137370	60	25,000	10
08834137371	80	25,000	10
08834137372	120	25,000	10
08834137373	180	25,000	10
08834137374	240	25,000	10
08834137375	320	25,000	10

PART #	GRIT	MAX. RPM	STD. PKG.
2" x 1-1/2" x 1/4"			
08834137183	40	25,000	10
08834137380	60	25,000	10
08834137381	80	25,000	10
08834137382	120	25,000	10
08834137383	180	25,000	10
2-1/2" x 1" x 1/4"			
08834137410	60	20,000	10
08834137411	80	20,000	10
08834137412	120	20,000	10
08834137413	180	20,000	10
08834137633	240	20,000	10
2-1/2" x 1-1/2" x 1/4"			
08834137420	60	20,000	10
08834137421	80	20,000	10
08834137422	120	20,000	10
3" x 1" x 1/4"			
08834137456	40	20,000	10
08834137450	60	20,000	10
08834137451	80	20,000	10
08834137252	120	20,000	10
08834137253	180	20,000	10
08834135339	240	20,000	10
08834135341	320	20,000	10
3" x 2" x 1/4"			
08834137460	40	12,000	10
08834137260	60	12,000	10
08834137261	80	12,000	10
08834137262	120	12,000	10
08834137263	180	12,000	10



Good Tier / Aluminum Oxide



Good choice when initial price is the main consideration.

FEATURES	BENEFITS
• Quality aluminum oxide abrasive	• Good cut rate and life
• Engineered cotton backing	• Longer life and wear resistance
• Low initial price point	• Best starting specification for end-user unable to measure total performance

PART #	GRIT	MAX. RPM	STD. PKG.
1" x 1/2" x 1/4"			
08834149802	120	30,000	10
1" x 1" x 1/4"			
08834149803	40	30,000	10
08834149804	60	30,000	10
08834149806	120	30,000	10
08834149807	180	30,000	10
1-1/2" x 1/2" x 1/4"			
08834149810	60	25,000	10
08834149811	80	25,000	10
08834149812	120	25,000	10
1-1/2" x 1" x 1/4"			
08834149816	60	25,000	10
08834149817	80	25,000	10
08834149818	120	25,000	10
2" x 1/2" x 1/4"			
08834149821	60	25,000	10
08834149822	80	25,000	10
08834149823	120	25,000	10

PART #	GRIT	MAX. RPM	STD. PKG.
2" x 1" x 1/4"			
08834149824	40	25,000	10
08834149825	60	25,000	10
08834149826	80	25,000	10
08834149828	180	25,000	10
3" x 1/2" x 1/4"			
08834149834	60	20,000	10
08834149835	80	20,000	10
3" x 1" x 1/4"			
08834149836	40	20,000	10
08834149837	60	20,000	10
08834149838	80	20,000	10
08834149839	120	20,000	10
08834149840	180	20,000	10



MERIT FLAP WHEEL TEST KITS



Merit Micro Mini Test Kit "MMC": The flap wheels are mounted on 1/8" diameter hardened steel shanks. Ideal for fast polishing and light deburring of holes or grooves.

Merit Mini Test Kit "CMM": Each wheel comes with a 1/4" steel mandrel permanently mounted. Merit Mini 1/4"-20 Thread Test Kit "CQ".

Merit Mini 1/4"-20 Thread Test Kit "CQ": This flap wheel kit includes a 1/4"-20 QC-4 quick-change adapter.

PART #	DESCRIPTION	STD. PKG.
MICRO-MINI TEST KIT "MMC"		
08834131493	Includes 5 wheels, 3/8" to 1-3/16" in diameter	1
MERIT MINI TEST KIT "CMM"		
08834138004	Includes ten wheels, 1" to 3" diameter in various grits	1
MERIT MINI 1/4"-20 THREAD TEST KIT "CQ"		
08834138001	Includes ten, 1" to 3" diameter, 1/4"-20 thread mini flap wheels	1

MERIT HIGH PERFORMANCE MINI FLAP WHEELS WITH 1/4"-20 THREAD



Best Tier / Ceramic Alumina/Aluminum Oxide Blend



Best choice for more durable flap wheel applications where aggressive cut and superior life are required

FEATURES	BENEFITS
<ul style="list-style-type: none"> Long-lasting ceramic alumina/aluminum oxide abrasive grain blend Heavy cotton backing 	<ul style="list-style-type: none"> Aggressive cut and 2 to 3 times longer life Extended durability for added life and reduced edge wear

PART #	GRIT	MAX. RPM	STD. PKG.
1" x 5/8" x 1/4"-20			
08834131001	60	30,000	10
08834131002	80	30,000	10
08834131003	120	30,000	10
1" x 1" x 1/4"-20			
08834131027	40	30,000	10
08834131008	60	30,000	10
08834131009	80	30,000	10
08834131010	120	30,000	10
08834131011	180	30,000	10
08834131012	240	30,000	10
08834131013	320	30,000	10
1-3/8" x 5/8" x 1/4"-20			
08834132001	60	30,000	10
08834132002	80	30,000	10
08834132003	120	30,000	10
1-5/8" x 1" x 1/4"-20			
08834132051	40	25,000	10
08834132015	60	25,000	10
08834132016	80	25,000	10
08834132017	120	25,000	10
08834132018	180	25,000	10
08834132020	320	25,000	10
2" x 3/4" x 1/4"-20			
08834133008	60	25,000	10
08834133009	80	25,000	10
08834133010	120	25,000	10
08834133011	180	25,000	10

PART #	GRIT	MAX. RPM	STD. PKG.
2" x 1" x 1/4"-20			
08834133044	40	25,000	10
08834133015	60	25,000	10
08834133016	80	25,000	10
08834133017	120	25,000	10
08834133018	180	25,000	10
08834133019	240	25,000	10
08834133020	320	25,000	10
2" x 1-1/2" x 1/4"-20			
08834135201	60	25,000	10
08834135202	80	25,000	10
08834135203	120	25,000	10
08834135204	180	25,000	10
2-1/2" x 1" x 1/4"-20			
08834134061	40	20,000	10
08834134022	60	20,000	10
08834134023	80	20,000	10
08834134024	120	20,000	10
08834134025	180	20,000	10
3" x 3/4" x 1/4"-20			
08834135008	60	20,000	10
3" x 1" x 1/4"-20			
08834135230	40	20,000	10
08834135015	60	20,000	10
08834135016	80	20,000	10
08834135017	120	20,000	10
08834135018	180	20,000	10
08834135019	240	20,000	10

For flap wheel adapters and bushings, see the last page of this section.



MERIT CUP-TYPE MINI FLAP WHEELS



Good Tier / Aluminum Oxide with 1/4" Mounted Steel Shanks

Primarily used for bottom or side-wall type sanding where conventional tools do not reach.

FEATURES	BENEFITS
<ul style="list-style-type: none"> Cup-type flap wheel 	<ul style="list-style-type: none"> Will not mar your workpiece while reaching flush into areas where other wheels cannot

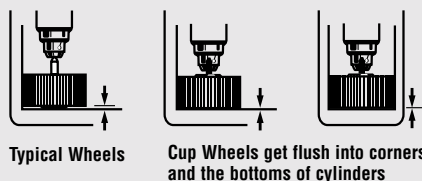

PART #	GRIT	MAX. RPM	STD. PKG.
2-1/2" x 1-1/2" x 1/4"			
08834144463	60	20,000	10



MERIT HIGH PERFORMANCE 3-1/2" - 8" FLAP WHEELS WITH ARBOR HOLES



Best Tier / Ceramic Alumina/Aluminum Oxide Blend



Best choice for more durable flap wheel applications where aggressive cut and superior life are required

FEATURES	BENEFITS
<ul style="list-style-type: none"> Long-lasting ceramic alumina/aluminum oxide abrasive grain blend Heavy cotton backing 	<ul style="list-style-type: none"> Aggressive cut and 2 to 3 times longer life Extended durability for added life and reduced edge wear

PART #	GRIT	MAX. RPM	STD. PKG.
3-1/2" x 1-1/2" x 5/8"			
08834122013	60	12,000	10
3-1/2" x 2" x 5/8"			
08834122024	60	12,000	10
4" x 1" x 5/8"			
08834122034	60	12,000	10
08834122035	80	12,000	10
08834122037	120	12,000	10
4" x 2" x 5/8"			
08834122054	50	12,000	10
08834122055	60	12,000	10
08834122056	80	12,000	10
08834122058	120	12,000	10
5" x 1-1/2" x 5/8"			
08834122065	60	12,000	10
08834122066	80	12,000	10
6" x 1/2" x 1"			
08834123003	60	6,000	10
08834123005	120	6,000	10
08834123006	180	6,000	10
6" x 1" x 1"			
08834123009	40	6,000	5
08834123011	60	6,000	5
08834123012	80	6,000	5
08834123014	120	6,000	5
08834123016	180	6,000	5
08834123018	320	6,000	5

PART #	GRIT	MAX. RPM	STD. PKG.
6" x 1-1/2" x 1"			
08834123022	60	6,000	5
08834123023	80	6,000	5
08834123025	120	6,000	5
6" x 2" x 1"			
08834123033	60	6,000	5
08834123034	80	6,000	5
08834123036	120	6,000	5
08834123038	180	6,000	5
6" x 3" x 1"			
08834123056	80	6,000	3
08834123058	120	6,000	3
8" x 1" x 1"			
08834123072	60	4,500	3
08834123073	80	4,500	3
08834123075	120	4,500	3
08834123077	180	4,500	3
08834123078	240	4,500	3
8" x 2" x 1"			
08834123095	80	4,500	3

For flap wheel adapters and bushings, see the last page of this section.



MERIT 6" FLAP WHEELS WITH ARBOR HOLES



Good Tier / Aluminum Oxide



Good choice when initial price is the main consideration.

FEATURES	BENEFITS
<ul style="list-style-type: none"> Quality aluminum oxide abrasive Engineered cotton backing Low initial price point 	<ul style="list-style-type: none"> Good cut rate and life Longer life and wear resistance Best starting specification for end-user unable to measure total performance

PART #	GRIT	MAX. RPM	STD. PKG.
6" x 1" x 1"			
08834120169	60	6,000	5
08834120170	80	6,000	5
08834120172	120	6,000	5

For flap wheel adapters and bushings, see the last page of this section.



ADAPTER AND BUSHINGS FOR FLAP WHEELS WITH ARBOR HOLES

Accessory



08834125001



08834125003



08834125027



08834125017 & 08834125018

PART #	WHEEL DIAMETER	ADAPTERS	STD. PKG.
SHANK ADAPTERS			
08834125001	3-1/2"	1/4" Shank	1
08834125003	4" - 8"	1/4" Shank	1
THREADED MOUNTING ADAPTERS			
08834125027	4" - 8"	5/8"-11 Thread	1
REDUCING BUSHINGS			
08834125017	6" - 8"	1" to 1/2"	1
08834125018	6" - 8"	1" to 5/8"	1
Standard packages = 1 adapter, 1 pair of bushings			

ADAPTERS FOR 1/4"-20 THREAD MINI AND ARBOR HOLE FLAP WHEELS

Accessory

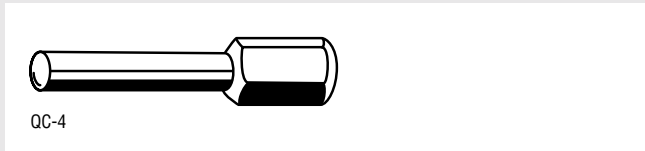

QC-4

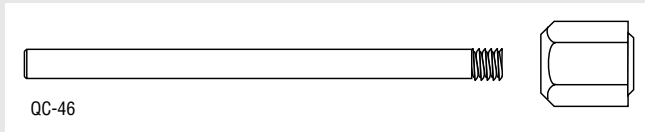

QC-46

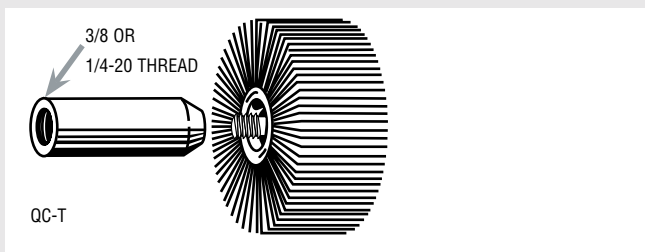

QC-T

PART #	MODEL #	DESCRIPTION	STD. PKG.
ADAPTERS			
08834137001	QC-4	1/4" Shank Dia. x 5/8" Shank Length	1
08834137003	QC-44	1/4" x 4"	1
08834137004	QC-46	1/4" x 6"	1
08834137005	QC-48	1/4" x 8"	1
08834137012	QC-T	1/4"-20 Thread	1
08834137010	QC-T	3/8"-24 Thread	1
Standard package = 1 adapter			
Other thread sizes available for quotation			



APPLICATION/GRIT RECOMMENDATION GUIDE

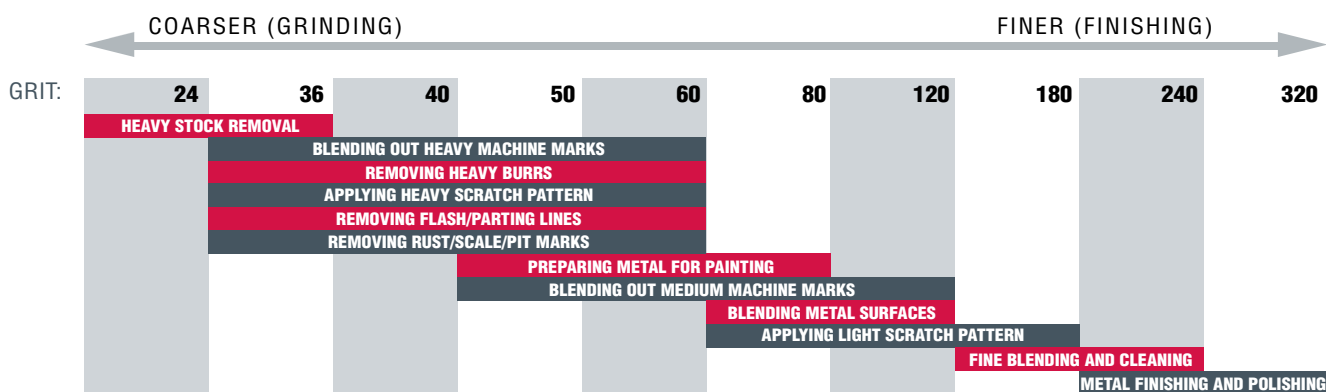

EXPANDING RUBBER DRUMS

Accessory



Designed for use with spiral bands, these drums are fabricated from rubber for controlled expansion keeping the band from slipping during use

PART #	SIZE (D X W X SK.)	MAX. RPM	STD. PKG.
08834196030	1/4" x 1/2" x 1/8"	30,000	1
08834196944	3/8" x 1/2" x 1/8"	30,000	1
08834196904	1/2" x 1/2" x 1/4"	30,000	1
08834196906	1/2" x 1" x 1/4"	15,000	1
08834196907	1/2" x 1-1/2" x 1/4"	12,000	1
08834196908	1/2" x 2" x 1/4"	10,000	1
08834196910	3/4" x 3/4" x 1/4"	24,000	1
08834196911	3/4" x 1" x 1/4"	17,000	1
08834196912	3/4" x 1-1/2" x 1/4"	10,000	1
08834196913	3/4" x 2" x 1/4"	10,000	1
08834196916	1" x 1" x 1/4"	18,000	1
08834196917	1" x 1-1/2" x 1/4"	10,000	1
08834196918	1" x 2" x 1/4"	8,000	1
08834196921	1-1/2" x 1" x 1/4"	12,000	1
08834196922	1-1/2" x 1-1/2" x 1/4"	10,000	1
08834196923	1-1/2" x 2" x 1/4"	8,000	1
08834196926	2" x 1" x 1/4"	11,000	1
08834196927	2" x 1-1/2" x 1/4"	8,000	1
08834196928	2" x 2" x 1/4"	6,000	1
08834196931	3" x 3" x 3/8"	3,000	1



Best product for blending and polishing contours when smooth running is a primary concern. Used for finishing hard-to-reach areas, removing parting lines, imperfections, and burrs on all surfaces.

FEATURES	BENEFITS
• One ply of abrasive	• Spiral construction avoids shadow marks and provides smooth, chatter-free cutting action
• Strong X-weight backing construction	• Achieves close tolerances when finishing curved, contoured, and hard-to-reach areas
• Premium aluminum oxide abrasive	• Fast cutting and removes toughest metal
• No tools required for changes	• Bands are easily removed and replaced

PART #	GRIT	STD. PKG.
1/2" x 1/2"		
08834196228	50	100/box
08834196179	80	100/box
08834196189	100	100/box
08834196069	120	100/box
1/2" x 1"		
08834196591	36	100/box
08834196212	60	100/box
08834196215	80	100/box
3/4" x 3/4"		
08834196168	60	100/box
08834196161	80	100/box
3/4" x 1"		
08834196261	36	100/box
08834196515	50	100/box
08834196070	60	100/box
08834196071	80	100/box
08834196219	120	100/box
3/4" x 1-1/2"		
08834196596	24	100/box
08834196554	60	100/box
08834196249	80	100/box
3/4" x 2"		
08834196756	80	100/box
1" x 1"		
08834196072	36	100/box
08834196073	40	100/box
08834196184	50	100/box
08834196075	60	100/box
08834196074	80	100/box
08834196177	120	100/box
1" x 1-1/2"		
08834196525	36	100/box
1" x 2"		
08834196268	80	100/box
1" x 3"		
08834197806	24	100/box
08834196665	36	100/box
08834197688	50	100/box
08834196676	60	100/box
08834196195	80	100/box
08834196445	100	100/box
08834196197	120	100/box

PART #	GRIT	STD. PKG.
1-1/2" x 1-1/2"		
08834196164	36	100/box
08834196176	50	100/box
08834196091	60	100/box
08834196165	80	100/box
1-1/2" x 2"		
08834196067	60	100/box
08834196533	80	100/box
1-1/2" x 3"		
08834197063	36	100/box
08834196703	60	100/box
08834196809	80	100/box
08834196522	100	100/box
08834196343	120	100/box
08834197869	180	100/box
2" x 1"		
08834196166	80	100/box
08834196595	120	100/box
2" x 2"		
08834196110	36	100/box
08834196173	60	100/box
2" x 3"		
08834197903	24	100/box
08834196827	36	100/box
08834196151	40	100/box
08834196152	50	100/box
08834196175	60	100/box
08834196198	80	100/box
08834196199	100	100/box
2-1/4" x 3"		
08834197140	36	100/box
08834197158	40	100/box
08834196620	50	100/box
08834196270	80	100/box
08834196729	120	100/box
08834195857	150	100/box
08834195825	320	100/box

PART #	GRIT	STD. PKG.
3" x 2"		
08834196263	24	100/box
08834196545	36	100/box
08834196090	40	100/box
08834196264	50	100/box
08834196530	60	100/box
08834196265	80	100/box
08834196531	120	100/box
3" x 3"		
08834196256	24	100/box
08834196262	36	100/box
08834196555	40	100/box
08834196253	50	100/box
08834196188	60	100/box
08834196159	80	100/box
08834196250	100	100/box
08834196572	120	100/box
08834196452	150	100/box
08834196574	240	100/box
08834197968	320	100/box



Cartridge Rolls

- Effective for flash removal
- Polishing or removing machine tool marks
- Edge breaking
- Valuable abrasive tool for reaching into corners, where larger diameter tools cannot work
- All cartridge roll part numbers shown are resin bond, half-glued
- Quarter and full glue are also available for quotation as made-to-order



MERIT CARTRIDGE ROLLS

Best Tier / Ceramic Alumina with Grinding Aid



With their exclusive ceramic grain technology, grinding aid, and x-weight cotton backing, Merit ceramic alumina products cut cooler and last longer, outperforming all competitive ceramic, zirconia, and aluminum oxide specialty products in today's markets on stainless steel, cobalt, Inconel, titanium, and other hard-to-grind materials.



FEATURES	BENEFITS
<ul style="list-style-type: none"> • Next-generation ceramic alumina abrasive grain 	<ul style="list-style-type: none"> • Significantly faster cut rates • Resists wear, resulting in 50% – 300% longer life • Greatest productivity
<ul style="list-style-type: none"> • Advanced grinding aid 	<ul style="list-style-type: none"> • Cooler cutting, longer life
<ul style="list-style-type: none"> • Durable resin bond system 	<ul style="list-style-type: none"> • Exceptional grain retention and longer life

PART #	USE MANDREL	GRIT	STD. PKG.
1/4" x 1-1/2" x 1/8"			
66261194384	M-9	60	100
66261194394	M-9	80	100
66261194397	M-9	120	100
3/8" x 1-1/2" x 1/8"			
66261194392	M-9	60	100
66261194395	M-9	80	100
66261194398	M-9	120	100
1/2" x 1-1/2" x 1/8"			
66261194393	M-9	60	100
66261194396	M-9	80	100
66261194399	M-9	120	100



See cartridge and spiral roll mandrels on page 95.

MERIT CARTRIDGE ROLLS

Better Tier / Ceramic Alumina Blend with Grinding Aid



Ceramic abrasive blend on X-weight cotton backing with grinding aid results in cooler cut on stainless steel and other harder-to-grind materials.



FEATURES	BENEFITS
<ul style="list-style-type: none"> • Ceramic blend 	<ul style="list-style-type: none"> • Cool cut and long life
<ul style="list-style-type: none"> • X-weight cotton backing 	<ul style="list-style-type: none"> • Durability and even wear
<ul style="list-style-type: none"> • Grinding aid 	<ul style="list-style-type: none"> • Cooler cut on stainless steel

PART #	USE MANDREL	GRIT	STD. PKG.
1/4" x 1-1/2" x 1/8"			
66261040470	M-9	60	100
69957300001	M-9	80	100
3/8" x 1-1/2" x 1/8"			
66261041270	M-9	60	100
08834187134	M-9	80	100
1/2" x 1-1/2" x 1/8"			
08834184221	M-9	60	100
66261012798	M-9	80	100



See cartridge and spiral roll mandrels on page 95.





Effective starting specification for flash removal, polishing or removing machine tool marks and edge breaking on all types of metal.

FEATURES	BENEFITS
• Quality aluminum oxide abrasive	• Tough and durable
• Strong X-weight cotton backing construction	• For extended durability and even wear
• Durable resin bond system	• Provides longer life

PART #	USE MANDREL	GRIT	STD. PKG.
3/16" x 3/4" x 3/32"			
08834180005	M-2E	80	100
3/16" x 1" x 3/32"			
08834180023	M-2E	60	100
08834180024	M-2E	80	100
08834180025	M-2E	100	100
08834180026	M-2E	120	100
08834180027	M-2E	150	100
08834180028	M-2E	180	100
08834180030	M-2E	240	100
08834180032	M-2E	320	100
1/4" x 3/4" x 1/8"			
08834180042	M3/M-7	60	100
08834180043	M3/M-7	80	100
08834180045	M3/M-7	120	100
1/4" x 1" x 1/8"			
08834180060	M-4/M-8	50	100
08834180061	M-4/M-8	60	100
08834180062	M-4/M-8	80	100
08834180063	M-4/M-8	100	100
08834180064	M-4/M-8	120	100
08834180065	M-4/M-8	150	100
08834180066	M-4/M-8	180	100
08834180068	M-4/M-8	240	100
08834180070	M-4/M-8	320	100
1/4" x 1-1/2" x 1/8"			
08834180079	M-9	50	100
08834180080	M-9	60	100
08834180081	M-9	80	100
08834180082	M-9	100	100
08834180083	M-9	120	100
08834180084	M-9	150	100
08834180085	M-9	180	100
08834180089	M-9	320	100
1/4" x 2" x 1/8"			
08834180100	M-10	80	100
08834180101	M-10	100	100
08834180102	M-10	120	100
5/16" x 1" x 1/8"			
08834180137	M-4/M-8	60	100
08834180138	M-4/M-8	80	100
08834180140	M-4/M-8	120	100
5/16" x 1-1/2" x 1/8"			
08834180156	M-9	60	100
08834180157	M-9	80	100
08834180159	M-9	120	100
3/8" x 3/4" x 1/8"			
08834180194	M7	60	100
08834180195	M7	80	100
08834180197	M7	120	100

PART #	USE MANDREL	GRIT	STD. PKG.
3/8" x 1" x 1/8"			
08834180211	M-8	40	100
08834180212	M-8	50	100
08834180213	M-8	60	100
08834180214	M-8	80	100
08834180215	M-8	100	100
08834180216	M-8	120	100
08834180217	M-8	150	100
08834180218	M-8	180	100
08834180220	M-8	240	100
3/8" x 1-1/2" x 1/8"			
08834180228	M-9	36	100
08834180229	M-9	40	100
08834180230	M-9	50	100
08834180231	M-9	60	100
08834180232	M-9	80	100
08834180233	M-9	100	100
08834180234	M-9	120	100
08834180235	M-9	150	100
08834180236	M-9	180	100
08834180238	M-9	240	100
08834180240	M-9	320	100
3/8" x 2" x 1/8"			
08834180250	M-10	60	100
08834180251	M-10	80	100
08834180252	M-10	100	100
08834180253	M-10	120	100
1/2" x 3/4" x 1/8"			
08834180270	M-7	80	100
1/2" x 1" x 1/8"			
08834180286	M-8	40	100
08834180287	M-8	50	100
08834180288	M-8	60	100
08834180289	M-8	80	100
08834180290	M-8	100	100
08834180291	M-8	120	100
08834180292	M-8	150	100
08834180293	M-8	180	100
08834180295	M-8	240	100
08834180297	M-8	320	100
1/2" x 1-1/2" x 1/8"			
08834180304	M-9	36	100
08834180305	M-9	40	100
08834180306	M-9	50	100
08834180307	M-9	60	100
08834180308	M-9	80	100
08834180309	M-9	100	100
08834180310	M-9	120	100
08834180311	M-9	150	100
08834180312	M-9	180	100
08834180314	M-9	240	100
08834180316	M-9	320	100

PART #	USE MANDREL	GRIT	STD. PKG.
1/2" x 1-1/2" x 3/16"			
08834180919	M-16	120	100
1/2" x 2" x 1/8"			
08834180326	M-10	60	100
08834180327	M-10	80	100
08834180328	M-10	100	100
08834180329	M-10	120	100
08834180331	M-10	180	100
08834180333	M-10	240	100
08834180335	M-10	320	100
1/2" x 2" x 3/16"			
08834180350	M-17	60	100
08834180653	M-17	80	100
08834180338	M-17	120	100
1/2" x 2" x 1/4"			
08834183168	M-22	40	100
08834180351	M-22	80	100
5/8" x 1" x 3/16"			
08834180364	M-15	80	100
5/8" x 1-1/2" x 1/8"			
08834180395	M-9	36	100
08834180392	M-9	40	100
08834180393	M-9	50	100
08834180275	M-9	60	100
08834180789	M-9	80	100
08834180394	M-9	120	100
5/8" x 1-1/2" x 3/16"			
08834180381	M-16	50	100
08834180382	M-16	60	100
08834180383	M-16	80	100
5/8" x 2" x 1/8"			
08834182505	M-10	60	100
08834181080	M-10	80	100
5/8" x 2" x 3/16"			
08834180400	M-10	50	100
08834180401	M-10	60	100
08834180402	M-10	80	100
08834180403	M-10	100	100
3/4" x 1" x 1/8"			
08834180469	M-8	80	100
08834181543	M-8	120	100
3/4" x 1" x 3/16"			
08834180456	M-15	40	100
08834180459	M-15	80	100
08834180461	M-15	120	100

PART #	USE MANDREL	GRIT	STD. PKG.
3/4" x 1-1/2" x 1/8"			
08834180069	M-9	40	100
08834180490	M-9	60	100
08834180527	M-9	80	100
08834180487	M-9	120	100
3/4" x 1-1/2" x 3/16"			
08834180474	M-16	36	100
08834180476	M-16	50	100
08834180477	M-16	60	100
08834180478	M-16	80	100
08834180479	M-16	100	100
08834180480	M-16	120	100
08834180482	M-16	180	100
3/4" x 1-1/2" x 1/4"			
08834180907	M-21	36	100
08834180489	M-21	60	100
08834180358	M-21	80	100
08834180523	M-21	100	100
08834180488	M-21	120	100
08834182807	M-21	150	100
3/4" x 2" x 1/8"			
08834180791	M-10	60	100
3/4" x 2" x 3/16"			
08834180494	M-17	40	100
08834180496	M-17	60	100
08834180497	M-17	80	100
08834180498	M-17	100	100
08834180499	M-17	120	100
3/4" x 2" x 1/4"			
08834180506	M-22	60	100
08834181297	M-22	80	100
08834180507	M-22	120	100
1" x 1-1/2" x 1/8"			
08834180580	M-9	60	100
08834180584	M-9	80	100
1" x 1-1/2" x 1/4"			
08834181195	M-21	36	100
08834180587	M-21	60	100
08834180583	M-21	80	100
1" x 2" x 3/16"			
08834180589	M-17	40	100
08834180591	M-17	60	100
08834180592	M-17	80	100
1" x 2" x 1/4"			
08834180603	M-22	60	100
08834180606	M-22	80	100
08834180585	M-22	120	100



See cartridge and spiral roll mandrels on page 95.

MERIT CARTRIDGE ROLLS

Good Tier / Aluminum Oxide Plus

MERIT



Most effective starting specification for flash removal, polishing or removing machine tool marks and edge breaking on all types of metal.

FEATURES

- Premium aluminum oxide abrasive grain
- Advanced, full resin bond system

BENEFITS

- Controlled aggressiveness while cool cutting
- Excellent edge adhesion and long life

PART #	USE MANDREL	GRIT	STD. PKG.
1/4" x 1-1/2" x 1/8"			
77696089001	M-9	60	100
77696089002	M-9	80	100
77696089003	M-9	120	100
3/8" x 1-1/2" x 1/8"			
77696089004	M-9	60	100
77696089005	M-9	80	100
77696089006	M-9	120	100
1/2" x 1-1/2" x 1/8"			
77696089007	M-9	60	100
77696089008	M-9	80	100
77696089009	M-9	120	100

See cartridge and spiral roll mandrels on page 95.



MERIT CARTRIDGE ROLLS

Good Tier / Silicon Carbide

MERIT



Sharp silicon carbide grain penetrates tough, difficult-to-grind materials, as well as soft, loading materials: titanium, masonry, composites, plastic, and rubber.

FEATURES

- Sharp silicon carbide abrasive
- Durable resin bond system

BENEFITS

- Provides high initial cut on non-ferrous and soft-loading materials
- Exceptional grain retention and longer life

PART #	USE MANDREL	GRIT	STD. PKG.
1/4" x 1-1/2" x 1/8"			
08834183274	M-9	60	100
08834182359	M-9	80	100
08834189131	M-9	120	100
3/8" x 1-1/2" x 1/8"			
08834181309	M-9	60	100
08834180710	M-9	80	100
66261042229	M-9	120	100
1/2" x 1-1/2" x 1/8"			
08834189233	M-9	60	100
08834180712	M-9	80	100
66261086969	M-9	120	100

See cartridge and spiral roll mandrels on page 95.



MERIT SPECIALTIES – TEST KITS

MERIT



PART #	DESCRIPTION
MERIT BLAZE CARTRIDGE ROLL TEST KIT	
66261066726	Kit includes a variety of our Merit ceramic alumina cartridge rolls, spiral rolls and mandrels in popular sizes and grits.
MERIT ALUMINUM OXIDE CARTRIDGE ROLL TEST KIT "CR"	
08834181061	Includes over 120 pieces of our most popular sizes, grits and shapes with their appropriate mandrels.
MERIT GENERAL PURPOSE TEST KIT "GP"	
08834169025	Includes samples of various Merit abrasive specialties. One of these kits could be worth the cost of the entire kit by solving your problems in deburring, polishing and grinding.
MERIT PORTING TEST KIT "APK-MO"	
08834169032	The samples in this kit highlight Merit for general metal and wood working polishing and finishing applications.

Spiral Rolls

- All spiral roll part numbers shown are full tapered, resin bond, and half glued
- Half-tapered and sidewall-tapered are available for quotation
- Quarter and full glue are also available for quotation as made-to-order

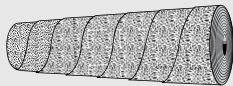

Full Taper

- Especially useful for grinding/polishing of channels, fillets and radii, and deburring small holes
- Full taper used when the area to finished is hard to reach with a full cartridge roll
- The tapered roll conforms to smaller areas
- Fits into irregular concaves, contours, channels



Half Taper

- Used when the area to be finished is not narrow but a beginning point on the roll is needed
- The portion of the roll that is not tapered is then used to finish off the sides



Sidewall Taper

- The portion of the roll that is tapered guides the roll down to the area to be finished
- The sidewall then finishes off the sides

APPLICATION/GRIT RECOMMENDATION GUIDE

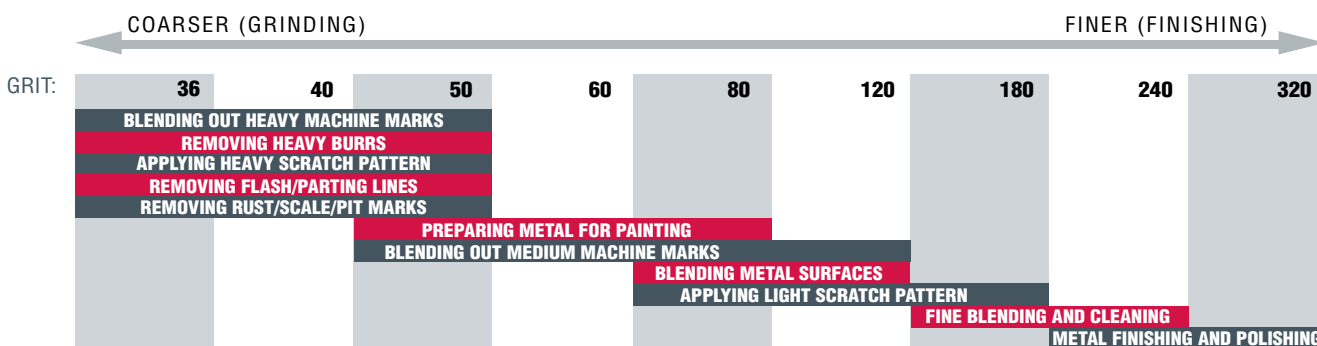

MERIT SPIRAL ROLLS

Best Tier / Ceramic Alumina with Grinding Aid – Full Taper



With their exclusive ceramic grain technology, grinding aid, and x-weight cotton backing, Merit ceramic alumina products cut cooler and last longer, outperforming all competitive ceramic, zirconia, and aluminum oxide specialty products in today's markets. on stainless steel, cobalt, Inconel, titanium, and other hard-to-grind materials.

FEATURES	BENEFITS
<ul style="list-style-type: none"> • Next-generation ceramic alumina abrasive grain 	<ul style="list-style-type: none"> • Significantly faster cut rates • Resists wear, resulting in 50% – 300% longer life • Greatest productivity
<ul style="list-style-type: none"> • Advanced grinding aid 	<ul style="list-style-type: none"> • Cooler cutting, longer life
<ul style="list-style-type: none"> • Durable resin bond system 	<ul style="list-style-type: none"> • Exceptional grain retention and longer life



PART #	USE MANDREL	GRIT	STD. PKG.
3/8" x 1-1/2" x 1/8"			
66261194481	M-9	60	100
66261194490	M-9	80	100
66261194491	M-9	120	100
1/2" x 1-1/2" x 1/8"			
66261194484	M-9	60	100
66261194492	M-9	80	100
66261194495	M-9	120	100

See cartridge and spiral roll mandrels on page 95.



MERIT SPIRAL ROLLS

Good Tier / Aluminum Oxide Plus – Full Taper



Especially useful for cooler grinding/polishing of channels, fillets and radii, and deburring small holes..

FEATURES	BENEFITS
• Premium aluminum oxide abrasive	• Run cooler and more efficiently; ideal for grinding exotic alloys
• Strong X-weight cotton backing construction	• For extended durability and even wear
• Advanced, full resin bond system	• Provides exceptional grain retention and longer life

PART #	USE MANDREL	GRIT	STD. PKG.
3/8" x 1-1/2" x 1/8"			
77696089010	M-9	60	100
77696089011	M-9	80	100
77696089012	M-9	120	100
1/2" x 1-1/2" x 1/8"			
77696089013	M-9	60	100
77696089014	M-9	80	100
77696089015	M-9	120	100



See cartridge and spiral roll mandrels on page 95.

MERIT SPIRAL ROLLS

Good Tier / Aluminum Oxide – Full Taper



Especially useful for grinding/polishing of channels, fillets and radii, and deburring small holes.

FEATURES	BENEFITS
• Quality aluminum oxide abrasive	• Tough and durable
• Strong X-weight cotton backing construction	• For extended durability and even wear
• Durable resin bond system	• Provides long life

PART #	USE MANDREL	GRIT	STD. PKG.
3/8" x 1" x 1/8"			
08834181714	M-8	60	100
08834181715	M-8	80	100
08834181717	M-8	120	100
3/8" x 1-1/2" x 1/8"			
08834181724	M-9	60	100
08834181708	M-9	80	100
08834181727	M-9	120	100
08834181728	M-9	150	100
08834181709	M-9	180	100
1/2" x 1" x 1/8"			
08834181734	M-8	60	100
08834181735	M-8	80	100
08834181737	M-8	120	100
1/2" x 1-1/2" x 1/8"			
08834181230	M-9	36	100
08834181743	M-9	50	100
08834181744	M-9	60	100
08834181745	M-9	80	100
08834181746	M-9	100	100
08834181747	M-9	120	100
08834181749	M-9	180	100
08834181750	M-9	240	100
1/2" x 2" x 1/8"			
08834181754	M-10	60	100
08834181755	M-10	80	100
08834181757	M-10	120	100

PART #	USE MANDREL	GRIT	STD. PKG.
5/8" x 1-1/2" x 1/8"			
08834181776	M-9	100	100
08834181777	M-9	120	100
08834183313	M-9	240	100
08834181781	M-9	320	100
5/8" x 1-1/2" x 3/16"			
08834181444	M-16	80	100
3/4" x 1-1/2" x 1/8"			
08834181286	M-9	60	100
08834180886	M-9	80	100
3/4" x 1-1/2" x 3/16"			
08834181807	M-16	50	100
08834181808	M-16	60	100
08834181809	M-16	80	100
08834181811	M-16	120	100
3/4" x 2" x 3/16"			
08834181820	M-17	60	100
1" x 1-1/2" x 1/8"			
08834181240	M-9	60	100
1" x 2" x 3/16"			
08834181875	M-17	36	100
08834181878	M-17	60	100
08834181879	M-17	80	100



See cartridge and spiral roll mandrels on page 95.



Sharp silicon carbide grain penetrates tough, difficult-to-grind materials, as well as soft, loading materials: titanium, masonry, composites, plastic, and rubber.

FEATURES	BENEFITS
<ul style="list-style-type: none"> • Sharp silicon carbide abrasive 	<ul style="list-style-type: none"> • Provides high initial cut on non-ferrous and soft- loading materials
<ul style="list-style-type: none"> • Durable resin bond system 	<ul style="list-style-type: none"> • Provides exceptional grain retention and longer life

PART #	USE MANDREL	GRIT	STD. PKG.
3/8" x 1-1/2" x 1/8"			
08834189904	M-9	80	100
66261046936	M-9	120	100
1/2" x 1-1/2" x 1/8"			
66261185977	M-9	60	100
08834183460	M-9	80	100
08834183448	M-9	120	100
66261042229	M-9	120	100

See cartridge and spiral roll mandrels below.



CARTRIDGE AND SPIRAL ROLL MANDRELS

Accessory

PART #	MODEL NO.	PILOT DIA.	PILOT LENGTH	SHANK DIA.	SHANK LENGTH	OVERALL LENGTH
CARTRIDGE AND SPIRAL ROLL MANDRELS						
08834183799	M-2E	3/32"	3/4"	1/4"	1"	3"
08834181202	M-2	3/32"	1"	1/8"	1"	3"
08834181203	M-3	1/8"	1/2"	1/8"	1"	2-1/2"
08834181204	M-4	1/8"	3/4"	1/8"	1"	2-1/2"
08834181205	M-5	1/8"	1"	1/8"	1"	2-3/4"
08834181206	M-6	1/8"	1-1/2"	1/8"	1"	2-1/2"
08834181207	M-7	1/8"	1/2"	1/4"	1-1/4"	2-1/4"
08834181208	M-8	1/8"	3/4"	1/4"	1-1/4"	2-1/2"
08834181209	M-9	1/8"	1"	1/4"	1-1/4"	2-3/4"
08834181210	M-10	1/8"	1-1/2"	1/4"	1-1/4"	3-1/4"

PART #	MODEL NO.	PILOT DIA.	PILOT LENGTH	SHANK DIA.	SHANK LENGTH	OVERALL LENGTH
CARTRIDGE AND SPIRAL ROLL MANDRELS (CONTINUED)						
08834181211	M-11	1/8"	2"	1/4"	1-1/4"	4"
08834181215	M-15	3/16"	3/4"	1/4"	1-1/4"	2-3/4"
08834181216	M-16	3/16"	1"	1/4"	1-1/4"	3"
08834181217	M-17	3/16"	1-1/2"	1/4"	1-1/4"	3-1/2"
08834181218	M-18	3/16"	2"	1/4"	1-1/4"	4"
08834181220	M-20	1/4"	3/4"	1/4"	1-1/4"	2-3/4"
08834181221	M-21	1/4"	1"	1/4"	1-1/4"	3"
08834181222	M-22	1/4"	1-1/2"	1/4"	1-1/4"	3-1/2"
08834181223	M-23	1/4"	2"	1/4"	1-1/4"	4"

Standard Package = 1

Tapered Cone Points

- Tapered cone points are similar to cartridge rolls but their shape lends greater accessibility to many difficult-to-reach work areas
- They are used for deburring holes and in close tolerance work areas
- Popular sizes and mandrels are listed, with additional sizes available as made-to-order



APPLICATION/GRIT RECOMMENDATION GUIDE

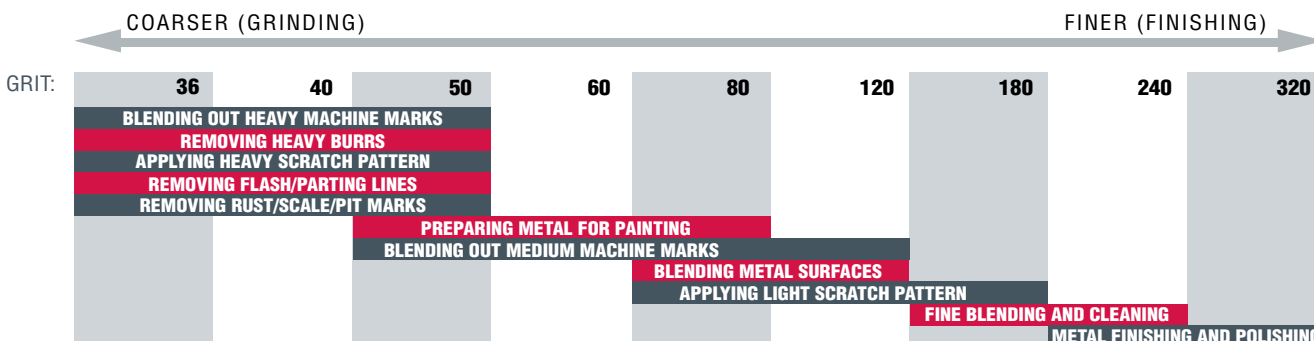

MERIT TAPERED CONE POINTS

Good Tier / Aluminum Oxide – Full Taper



Tapered cone points are similar to cartridge rolls but their shape lends greater accessibility to many difficult-to-reach work areas. They are used for deburring holes and in close tolerance work areas.

FEATURES	BENEFITS
• Premium aluminum oxide abrasive	• Provides long life
• Strong X-weight cotton backing construction	• For extended durability and even wear
• Durable resin bond system	• Exceptional grain retention and longer life

PART #	USE MANDREL	GRIT	STD. PKG.
5/16" x 1-1/2" x 5°			
08834180873	B-20	80	500
08834182043	B-20	100	500
08834182717	B-20	120	500
08834182535	B-20	180	500
08834182044	B-20	240	500
08834182537	B-20	320	500
3/16" x 1" x 2-1/2°			
08834186893	K-110	60	500
08834180918	K-110	80	500
08834182197	K-110	100	500
08834182199	K-110	120	500
08834186894	K-110	180	500
08834186895	K-110	240	500



EXTRA SHANK LENGTH MANDRELS

Accessory

PART NO.	MODEL NO.	SHANK LENGTH	OVERALL LENGTH	DIAMETER
08834180116	M-8-4	4"	5-1/4"	1/4"
08834180122	M-8-6	6"	7-1/4"	1/4"
08834180096	M-9-2.5	2-1/2"	4"	1/4"
08834180129	M-9-3	3"	4-1/2"	1/4"
08834180074	M-9-4	4"	5-1/2"	1/4"
08834180131	M-9-6	6"	7-1/2"	1/4"
08834180133	M-9-8	8"	9-1/2"	1/4"
08834180145	M-10-6	6"	8"	1/4"

Standard Package = 1

Recommended Pilot Length for Mandrels

ROLL LENGTH	USE PILOT
3/4"	1/2"
1"	3/4"
1-1/2"	1"
2"	1-1/2"

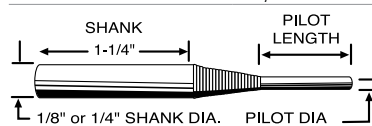

SPECIALTIES – SQUARE AND CROSS PADS, OVERLAP SLOTTED DISCS

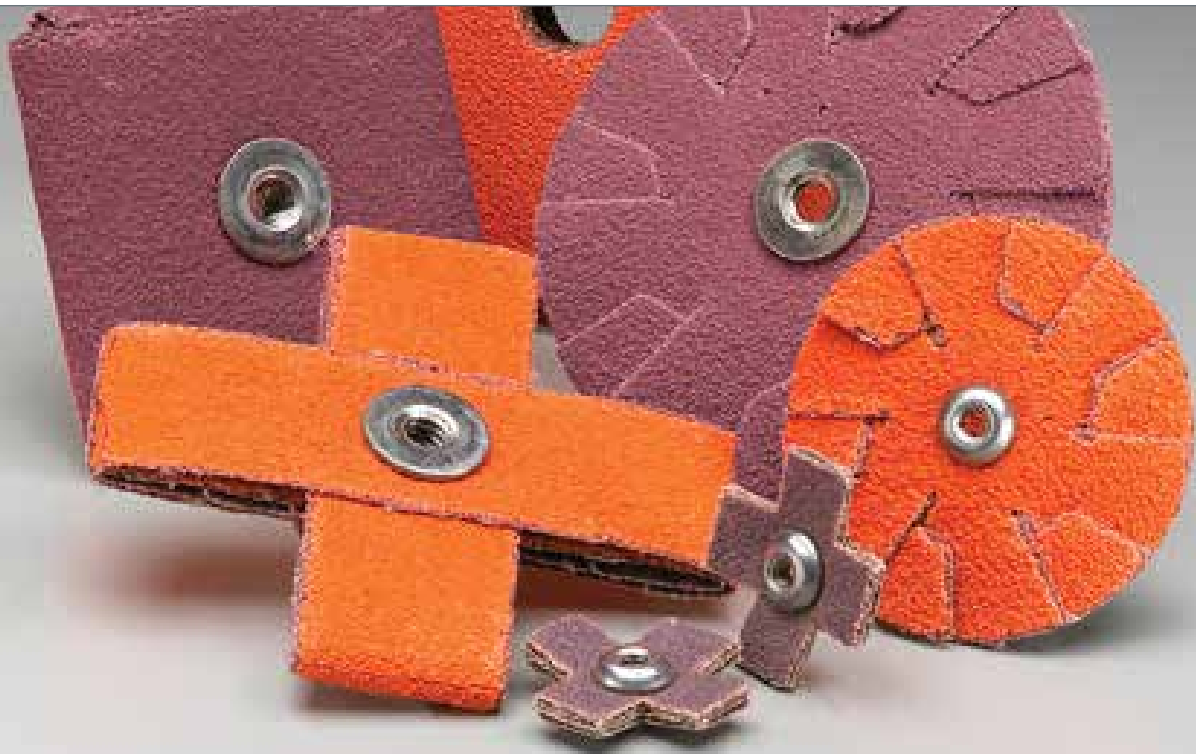

APPLICATION/GRIT RECOMMENDATION GUIDE

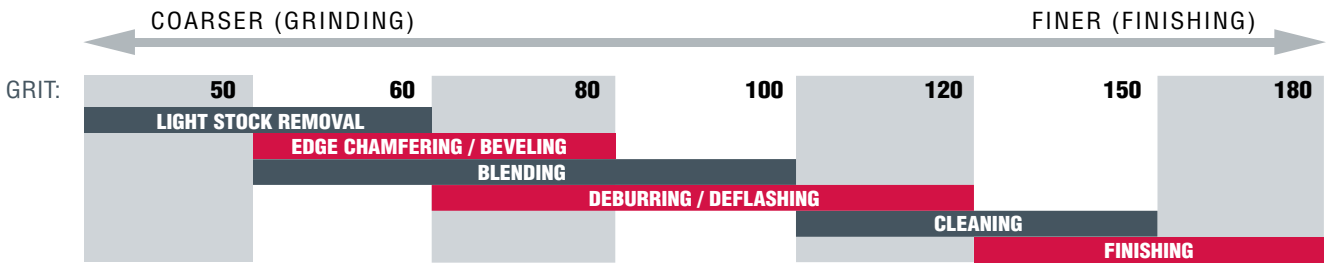

QUICK-CHANGE MANDRELS FOR OVERLAP SLOTTED DISCS, SQUARE AND CROSS PADS Accessory

PART #	MODEL #	CROSS PAD SIZE DIAMETER	SQUARE PAD SIZE DIAMETER	OVERALL LENGTH	THREAD SIZE
08834183162	MM48-4	1/4", 3/8", and 1/2" wide		2-1/2"	3-48
08834183163	MM32-4	3/4", 1" wide	Up thru 1-1/2" sq. x 1/2" thick	3"	8-32
08834183164	MM20-4	All pads 2-1/2" x 1-1/2" and larger	2" sq. x 1/4" or 1/2" thick and larger	3"	1/4-20

For overlap slotted discs, choose a mandrel with the same thread size as the disc.

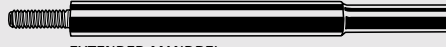

EXTENDED MANDREL

Square Pads

- With Merit square pads, corners wear down consistently exposing fresh abrasive; the pad becomes round for less aggressive stock removal
- Grind almost as fast as hard wheels, but are much smoother and easier to control
- For quick blending of channels, fillets, corners, or spotting flat surfaces

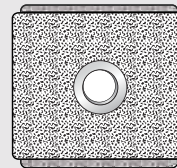

MERIT

MERIT SQUARE PADS

Best Tier / Ceramic Alumina with Grinding Aid

Best for hard-to-grind materials – stainless steel, cobalt, inconel, and titanium.

FEATURES	BENEFITS
<ul style="list-style-type: none"> • Next-generation ceramic alumina abrasive grain 	<ul style="list-style-type: none"> • Significantly faster cut rates • Resists wear, resulting in 50%-300% longer life • Greatest productivity
<ul style="list-style-type: none"> • Advanced grinding aid 	<ul style="list-style-type: none"> • Cooler cutting, longer life
<ul style="list-style-type: none"> • Durable resin bond system 	<ul style="list-style-type: none"> • Improved grain retention and longer life
<ul style="list-style-type: none"> • Standard quick-change eyelet for fast, easy mounting and removal on quick-change mandrels 	<ul style="list-style-type: none"> • Minimal downtime • Mandrel use increases range and versatility



PART #	EYELET	GRIT	STD. PKG.
2" x 2" x 1/2"			
66261194520	1/4-20	60	100
66261194552	1/4-20	80	100
66261194554	1/4-20	120	100
3" x 3" x 1/4"			
66261194531	1/4-20	60	100
66261194555	1/4-20	80	100
66261194556	1/4-20	120	100

PART #	EYELET	GRIT	STD. PKG.
3" x 3" x 1/2"			
66261194528	1/4-20	60	100
66261194557	1/4-20	80	100
66261194558	1/4-20	120	100

See quick-change mandrels for overlap slotted discs, square pads, and cross pads on page 97.



MERIT SQUARE PADS

Good Tier / Aluminum Oxide

Good for most ID deburring and polishing applications.

FEATURES	BENEFITS
<ul style="list-style-type: none"> • Quality aluminum oxide abrasive grain 	<ul style="list-style-type: none"> • Versatile; ideal for deburring, chamfering, and polishing most radii, holes, recesses, and cylinder walls
<ul style="list-style-type: none"> • Durable resin bond system 	<ul style="list-style-type: none"> • Good grain retention and life
<ul style="list-style-type: none"> • Standard quick-change eyelet for fast, easy mounting and removal on quick-change mandrels 	<ul style="list-style-type: none"> • Minimal downtime • Mandrel use increases range and versatility



PART #	EYELET	GRIT	STD. PKG.
1" x 1" x 6 PLY			
08834184826	8-32	80	100
1" x 1" x 8 PLY			
08834184828	8-32	60	100
08834184124	8-32	80	100
08834184994	8-32	120	100
1-1/2" x 1-1/2" x 1/2"			
08834184463	1/4-20	60	100
08834184125	1/4-20	80	100
2" x 2" x 1/2"			
08834184334	1/4-20	60	100
08834184397	1/4-20	80	100

PART #	EYELET	GRIT	STD. PKG.
2" x 2" x 3/4"			
08834184487	1/4-20	50	100
08834184394	1/4-20	80	100
3" x 3" x 1/4"			
08834184882	1/4-20	80	100
3" x 3" x 1/2"			
08834182152	1/4-20	50	100
08834182057	1/4-20	60	100
08834184336	1/4-20	80	100

See quick-change mandrels for overlap slotted discs, square pads, and cross pads on page 97.



MERIT

Cross Pads

- The shape of Merit's cross pads enables you to see through to the contact area, and provides greater flexibility than square pads to conform to variable internal diameters
- Used for close-tolerance polishing of small radii and channels, deburring, and finishing of bell-mouth configurations
- All pads are furnished with standard quick-change eyelet, as listed
- Plain hole sizes must be specified and are made-to-order

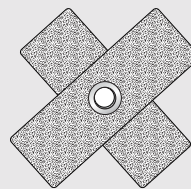

MERIT CROSS PADS

Best Tier / Ceramic Alumina with Grinding Aid



Best for hard-to-grind materials – stainless steel, cobalt, Inconel, and titanium.

FEATURES	BENEFITS
<ul style="list-style-type: none"> • Next-generation ceramic alumina abrasive grain 	<ul style="list-style-type: none"> • Significantly faster cut rates • Resists wear, resulting in 50%-300% longer life • Greatest productivity
<ul style="list-style-type: none"> • Advanced grinding aid 	<ul style="list-style-type: none"> • Cooler cutting, longer life
<ul style="list-style-type: none"> • Durable resin bond system 	<ul style="list-style-type: none"> • Improved grain retention and longer life
<ul style="list-style-type: none"> • Standard quick-change eyelet for fast, easy mounting and removal on quick-change mandrels 	<ul style="list-style-type: none"> • Minimal downtime • Mandrel use increases range and versatility

PART #	PLY	EYELET	GRIT	STD. PKG.
1-1/2" x 1-1/2" x 1/2"				
66261194496	8	8-32	60	100
66261194508	8	8-32	80	100
66261194511	8	8-32	120	100
2" x 2" x 3/4"				
66261194502	8	8-32	60	100
66261194513	8	8-32	80	100
66261194516	8	8-32	120	100

PART #	PLY	EYELET	GRIT	STD. PKG.
3" x 3" x 1"				
66261194504	8	1/4-20	60	100
66261194549	8	1/4-20	80	100
66261194551	8	1/4-20	120	100

See quick-change mandrels for overlap slotted discs, square pads, and cross pads on page 97.



MERIT CROSS PADS

Good Tier / Aluminum Oxide



Good for most ID deburring and polishing applications.

FEATURES	BENEFITS
<ul style="list-style-type: none"> • Quality aluminum oxide abrasive grain 	<ul style="list-style-type: none"> • Versatile; ideal for deburring, chamfering, and polishing most radii, holes, recesses, and cylinder walls
<ul style="list-style-type: none"> • Durable resin bond system 	<ul style="list-style-type: none"> • Good grain retention and life
<ul style="list-style-type: none"> • Standard quick-change eyelet for fast, easy mounting and removal on quick-change mandrels 	<ul style="list-style-type: none"> • Minimal downtime • Mandrel use increases range and versatility

PART #	PLY	EYELET	GRIT	STD. PKG.
3/4" x 3/4" x 3/8"				
08834185578	8	3-48	80	100
1" x 1" x 3/8"				
08834184943	8	3-48	60	100
08834185519	8	3-48	80	100
08834184195	8	3-48	100	100
08834185164	8	3-48	120	100
1-1/2" x 1-1/2" x 1/2"				
08834184258	8	8-32	60	100
08834184465	8	8-32	80	100
08834182196	8	8-32	100	100
08834182148	8	8-32	120	100
2" x 2" x 1/2"				
08834182156	8	8-32	60	100
08834182157	8	8-32	80	100
08834182132	8	8-32	120	100

PART #	PLY	EYELET	GRIT	STD. PKG.
2" x 2" x 3/4"				
08834184128	8	8-32	60	100
08834184194	8	8-32	80	100
08834184285	8	8-32	120	100
2" x 2" x 1"				
08834184805	8	8-32	120	100
2-1/4" x 2-1/4" x 1/2"				
08834184402	8	8-32	80	100
2-1/2" x 2-1/2" x 3/4"				
08834184206	8	8-32	80	100
08834184074	8	8-32	120	100
3" x 3" x 1"				
08834182135	8	1/4-20	60	100
08834184119	8	1/4-20	80	100
08834184116	8	1/4-20	120	100

PART #	PLY	EYELET	GRIT	STD. PKG.
3" x 3" x 1"				
08834182140	10	1/4-20	80	100
3" x 3" x 1-1/2"				
08834182184	10	1/4-20	80	100
4" x 4" x 1"				
08834184142	8	1/4-20	60	100
08834184135	8	1/4-20	80	100
08834184377	8	1/4-20	120	100
4" x 4" x 1-1/2"				
08834184129	8	1/4-20	80	100
08834184370	8	1/4-20	120	100

See quick-change mandrels for overlap slotted discs, square pads, and cross pads on page 97.



Overlap Slotted Discs

- Used for deburring and polishing radii, holes and cylinder walls
- Our “2 to a set” configuration cuts on the inward motion only
- The “4 to a set” configuration, assembled back to back, cuts on both the inward and outward motions
- All discs are furnished with standard quick-change eyelet
- Plain hole sizes must be specified and are made-to-order

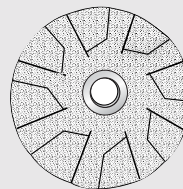

MERIT OVERLAP SLOTTED DISCS

Best Tier / Ceramic Alumina with Grinding Aid

MERIT

Best for hard-to-grind materials – stainless steel, cobalt, Inconel, and titanium

FEATURES	BENEFITS
<ul style="list-style-type: none"> • Next-generation ceramic alumina abrasive grain 	<ul style="list-style-type: none"> • Significantly faster cut rates • Resists wear, resulting in 50%-300% longer life • Greatest productivity
<ul style="list-style-type: none"> • Advanced grinding aid 	<ul style="list-style-type: none"> • Cooler cutting, longer life
<ul style="list-style-type: none"> • Durable resin bond system 	<ul style="list-style-type: none"> • Good grain retention and longer life
<ul style="list-style-type: none"> • Standard quick-change eyelet for fast, easy mounting and removal on quick-change mandrels 	<ul style="list-style-type: none"> • Minimal downtime • Mandrel use increases range and versatility



2 PER SET

PART #	EYELET	GRIT	STD. PKG.
1-1/2"			
66261195051	8-32	60	100
66261195368	8-32	80	100
66261195367	8-32	120	100
2"			
66261195054	8-32	60	100
66261195055	8-32	80	100
66261195056	8-32	120	100

PART #	EYELET	GRIT	STD. PKG.
3"			
66261195057	1/4-20	60	100
66261195058	1/4-20	80	100
66261195059	1/4-20	120	100

See quick-change mandrels for overlap slotted discs, square pads, and cross pads on page 97.





Good for most ID deburring and polishing applications

FEATURES	BENEFITS
<ul style="list-style-type: none"> Quality aluminum oxide abrasive grain 	<ul style="list-style-type: none"> Versatile; ideal for deburring, chamfering, and polishing most radii, holes, recesses, and cylinder walls
<ul style="list-style-type: none"> Durable resin bond system 	<ul style="list-style-type: none"> Good grain retention and life
<ul style="list-style-type: none"> Standard quick-change eyelet for fast, easy mounting and removal on quick-change mandrels 	<ul style="list-style-type: none"> Minimal downtime Mandrel use increases range and versatility

2 PER SET

PART #	EYELET	GRIT	STD. PKG.
1"			
08834184346	8-32	60	100
08834184019	8-32	80	100
08834184224	8-32	100	100
08834184151	8-32	120	100
08834185078	8-32	180	100
1-1/4"			
08834184270	8-32	60	100
08834184065	8-32	80	100
08834184291	8-32	100	100
08834184084	8-32	120	100
1-1/2"			
08834184066	8-32	60	100
08834184079	8-32	80	100
08834184279	8-32	100	100
08834186035	8-32	120	100
08834184498	8-32	180	100
1-3/4"			
08834184655	8-32	60	100
08834184042	8-32	80	100
2"			
08834184076	8-32	80	100
08834184145	8-32	100	100
08834184055	8-32	120	100
2-1/2"			
08834184444	8-32	80	100
3"			
08834184818	1/4-20	50	100
08834184041	1/4-20	60	100
08834184077	1/4-20	80	100
08834184082	1/4-20	100	100
08834184344	1/4-20	120	100
4"			
08834184000	1/4-20	60	100
08834184159	1/4-20	100	100
08834185155	1/4-20	120	100
4-1/2"			
08834184431	1/4-20	120	100
5"			
08834184302	1/4-20	100	100

4 PER SET





PART #	EYELET	GRIT	STD. PKG.
1"			
08834184085	8-32	80	100
08834184236	8-32	120	100
1-1/2"			
08834184023	8-32	100	100

See quick-change mandrels for overlap slotted discs, square pads, and cross pads on page 97.





APPLICATION-TO-PRODUCT SHAPE RECOMMENDATION GUIDE

SHAPE	APPLICATION
 <p>Bore Polisher Solid Flaps B-3 Series</p>	<ul style="list-style-type: none"> • For 5/8" to 1" interior diameter bores • 3 abrasive packs 1-1/2" wide, bonded to hub • Use with QC-5 mandrel Part # 08834154182
 <p>Bore Polisher Solid Flaps B-4 Series</p>	<ul style="list-style-type: none"> • For 1" to 4" interior diameter bores • 4 abrasive packs 1-1/2" wide, bonded to hub • Use with BPM-4 mandrel Part # 08834154183
 <p>Bore Polisher Solid Flaps B-8 Series</p>	<ul style="list-style-type: none"> • For 2" to 5-7/8" interior diameter bores • 8 abrasive packs 1-1/2" wide, bonded to hub • Use with BPM-8 mandrel Part # 08834154184
 <p>Bore Polisher Scored Flaps</p>	<p>Available as made-to-order. Contact your representative for quotation and lead-time information.</p>
 <p>Bore Polisher Interleaf</p>	<p>Merit interleaf bore polishers do double duty. Designed to polish and finish in one easy application, they are the ideal choice when close tolerances must be maintained while giving an interior a polished finish.</p>

APPLICATION/GRIT RECOMMENDATION GUIDE

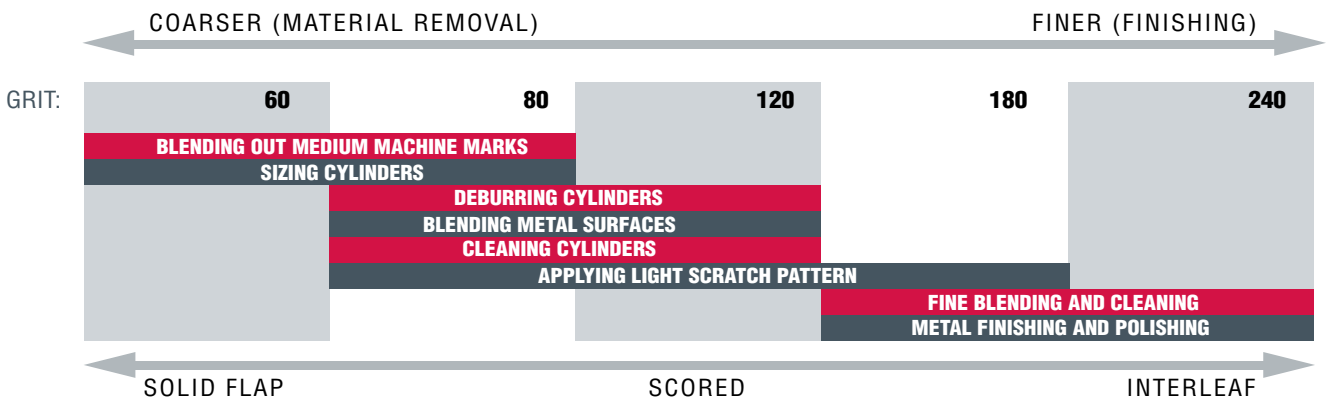



Bore polishers are self-centering, so they apply equal pressure to full wall of inside diameter. Spring action design gives faster inside diameter cleaning, deburring and polishing to cylinders, deep bores and tubes.

FEATURES	BENEFITS
• Premium aluminum oxide abrasive	• Provides long life
• Strong X-weight cotton backing construction	• For extended durability and even wear
• Durable resin bond system	• Provides exceptional grain retention and longer life

PART #	GRIT	MAX. RPM	STD. PKG.
B-305 – FITS I.D. 5/8" TO 1" – SOLID FLAP			
08834154190	60	25,000	10
08834154191	80	25,000	10
08834154193	120	25,000	10
08834154195	180	25,000	10
08834154197	240	25,000	10
B-405 – FITS I.D. 1" TO 1-1/2" – SOLID FLAP			
08834154091	60	22,000	10
08834154092	80	22,000	10
08834154093	120	22,000	10
08834154094	180	22,000	10
B-410 – FITS I.D. 1-1/2" TO 2" – SOLID FLAP			
08834154100	60	20,000	10
08834154101	80	20,000	10
08834154102	120	20,000	10
08834154103	180	20,000	10
08834154104	240	20,000	10
B-415 – FITS I.D. 2-1/8" TO 2-1/2" – SOLID FLAP			
08834154109	60	16,000	10
08834154110	80	16,000	10
08834154111	120	16,000	10
08834154112	180	16,000	10
B-420 – FITS I.D. 2-1/2" TO 3" – SOLID FLAP			
08834154118	60	15,000	10
08834154119	80	15,000	10
08834154120	120	15,000	10
08834154121	180	15,000	10
08834154122	240	15,000	10
B-425 – FITS I.D. 3-1/8" TO 4" – SOLID FLAP			
08834154127	60	10,000	10
08834154128	80	10,000	10
08834154129	120	10,000	10
08834154130	180	10,000	10
B-810 – FITS I.D. 2" TO 2-1/2" – SOLID FLAP			
08834154136	60	16,000	10
08834154137	80	16,000	10
08834154138	120	16,000	10
08834154139	180	16,000	10
08834154140	240	16,000	10

PART #	GRIT	MAX. RPM	STD. PKG.
B-815 – FITS I.D. 2-5/8" TO 3" – SOLID FLAP			
08834154145	60	15,000	10
08834154146	80	15,000	10
08834154147	120	15,000	10
08834154148	180	15,000	10
08834154149	240	15,000	10
B-820 – FITS I.D. 3-1/8" TO 4" – SOLID FLAP			
08834154154	60	10,000	10
08834154155	80	10,000	10
08834154156	120	10,000	10
08834154157	180	10,000	10
08834154158	240	10,000	10
B-825 – FITS I.D. 4-1/4" TO 5-1/4" – SOLID FLAP			
08834154163	60	8,000	10
08834154164	80	8,000	10
08834154165	120	8,000	10
08834154166	180	8,000	10
08834154167	240	8,000	10
B-830 – FITS I.D. 5-1/4" TO 5-7/8" – SOLID FLAP			
08834154172	60	8,000	10
08834154173	80	8,000	10
08834154174	120	8,000	10
08834154175	180	8,000	10
08834154176	240	8,000	10
BORE POLISHERS – SCORED FLAPS			
Available on request			
B-405 – FITS ID 1" TO 1-1/2" – INTERLEAF			
08834150271	80	22,000	10
08834150273	180	22,000	10
B-410 INTERLEAF – FITS ID 1-1/2" TO 2" – INTERLEAF			
08834150275	80	20,000	10



See mandrels for bore polishers on next page.

MANDRELS FOR BORE POLISHERS

Accessory

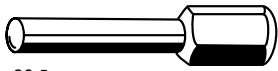

QC-5

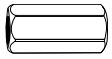

QC-5 EXT

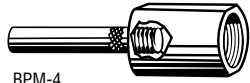

BPM-4



BPM-8

Choose mandrels to match the series of the bore polisher being used.

PART #	DESCRIPTION	MODEL NO.	THREAD
08834154182	For B-3 Series	QC-5	5/16-18
08834150573	QC-5 EXT	QC-5 EXT	5/16-18
08834154183	For B-4 Series	BPM-4	1/2-20
08834154184	For B-8 Series	BPM-8	1/4-20

Standard Package = 1

EXTENSION MANDRELS FOR BORE POLISHERS

Accessory

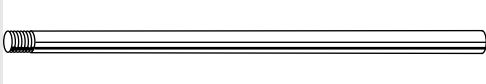

To extend a B-3 series bore polisher, attach the QC-5 Ext. to the bore polisher, then attach the desired length extension mandrel to the QC-5 Ext. To extend a B-4 series bore polisher, attach the adapter piece of the BPM-4 mandrel to the bore polisher, then attach the desired length extension mandrel to the BPM-4 adapter piece. To extend a B-8 series bore polisher, attach the desired length extension mandrel directly to the bore polisher.

PART #	MODEL NO.
1/4" x 4" x 1/4"-20 THREAD	
08834154185	EM-144
1/4" x 6" x 1/4"-20 THREAD	
08834154186	EM-146
1/4" x 8" x 1/4"-20 THREAD	
08834154187	EM-148

Standard Package = 1

MERIT BORE POLISHER TEST KIT

MERIT



Contains a variety of the most popular shapes and sizes of bore polishers.

PART #	DESCRIPTION
MERIT BORE POLISHER TEST KIT "BP"	
08834154181	Contains ten bore polishers and two mini 1/4"-20 thread flap wheels in assorted sizes and grits for finishing 1" to 5" interior diameters, and mandrel for 1/4" chuck.

HOW TO READ A COATED ABRASIVE SPECIFICATION

A coated abrasive product is made up of three basic raw materials: an abrasive mineral, the backing onto which the abrasive is applied, and an adhesive bond. The Carborundum Abrasives coated abrasive marking system includes both a generic and a technical marking.

The generic markings identify the abrasive type, bond, backing, and any special features and/or tradenames. An example would be: Premier Red Aluminum Oxide Dri-Lube Resin Paper Open.

The technical markings identify the actual components which make up the product. Technical markings consists of up to 10 parts. An example would be: P36 XBS 09 8 6 W O. The following terminology explains the technical marking system.

COATED ABRASIVE TERMINOLOGY KEY

GRADING		GRIT SIZE	BACKING	CLOTH TYPE	BACKING FLEXIBILITY	MINERAL	BACKING	BOND	PERFORMANCE	COATING
P	FEPA	12	Paper:	B Poly/ Cotton	F Flexible	00 Cork	0 Mesh	0 Glue	A Anti-Static	O Open Coat
—	ANSI	2000	A	Blend	— Standard	01 Crocus	1 Paper	1 U/G	D Dri-Lube Oversizee	— Closed Coat
			B			02 Emery	2 Comb.	2 U/U		
			C	C Cotton	S Stiff	03 Garnet	3 Film	3 R/G or U		
			D			04 S/C (Silicon Carbide)	4 Fiber			
			E			05 WA (White A/O)			R Reactive	
			F	G Glass		06 PA (Pink A/O)			W Washable or Waterproof	
			Cloth:	N Poly/ Nylon		07 LBA (Light Brown A/O)	5 Most Flexible	4 Least Durable		
			J			08 A/O (Aluminum Oxide)				
			X			09 HT A/O (Heat-Treated)				
			9.5 Micron	Y Polyester		10 Open				
			1/0	T Comb.	R Rayon	11 ZA (Zirconia Alumina)	9 Least Flexible	9 Most Durable		
			2/0	M Mesh		12 ZA (Premium)				
			3/0	V Fiber		23 Ceramic Alumina - Reduced Ratio				
			4/0	P Film		24 Open - Ceramic Alumina				
						25 Ceramic Alumina - Full Ratio				
						40 S/C-Cork Super Finishing				
						80 A/O-Cork Super Finishing				

ABRASIVE TYPES

Emery (02)

Emery is a dark gray, round-shaped grain which tends to polish rather than abrade a work surface.

- For polishing and cleaning metal only



Garnet (03)

Garnet is reddish brown in color. This natural abrasive is medium hard and relatively sharp, but not as durable as synthetic abrasives.

- For use on wood only
- Particularly good for soft woods such as pine
- Produces an excellent finish



Silicon Carbide (04)

Silicon carbide is the hardest and sharpest of the manufactured abrasives. Because of its extreme sharpness, this bluish-black abrasive grain permits fast stock removal and cool cut.

- Cast iron
- Non-ferrous metals, i.e. brass, aluminum and bronze
- Non-metallics, i.e. glass, rubber, plastic and stone
- Final finish on wood and stainless steel
- Abrasive planing particleboard



Light Brown Aluminum Oxide (07)

Light brown aluminum oxide is a tough, yet sharp synthetic abrasive characterized by cool cut, long life and the ability to break down under pressure, producing new cutting edges.

- Production wood sanding
- Non-ferrous metal finishing



Brown Aluminum Oxide (08)

Brown aluminum oxide is a tough, durable, synthetic abrasive characterized by the long life and wear resistance of its cutting edges. It offers enormous penetrating strength, even at high speeds.

- Ferrous metals
- Aluminum
- Hardwood



Heat-treated Aluminum Oxide (09)

Heat-treated aluminum oxide is a tough but cool cutting abrasive which gives both long life and freeness of cut on a wide range of materials.

- Ferrous metals
- Wood sanding



Zirconia Alumina (11, 12)

Zirconia alumina is an ultra-tough, synthetic abrasive which provides a free, cool cut for high stock removal applications. It is tougher and sharper than aluminum oxide. It has a micro-crystalline structure which allows for controlled breakdown and self-sharpening.

- Heavy-duty snagging and grinding of all ferrous and non-ferrous metals
- Abrasive planing of wood, plywood and particleboard
- Grinding fiberglass, rubber and plastics



Ceramic Alumina (23, 25)

The sub-micron structure of ceramic alumina allows each grain to continually expose sharp cutting points, resulting in a cooler cutting action and an extended life.

- All ferrous/non-ferrous metals, carbon steel and exotic alloys

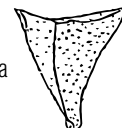

GRIT COMPARISON CHART

AVERAGE PARTICLE SIZE IN MICRONS	GRADING SYSTEMS (OTHER THAN EMERY)			EMERY PRODUCTS
	CAMI	FEPA	JIS	
5.0	-	-	-	-
6.0	-	-	3000	-
6.5	1200	-	2500	4/0
8.4	-	P2500	-	-
8.5	-	-	2000	-
9.2	1000	-	-	3/0
10.3	-	P2000	-	-
10.5	-	-	1500	-
12.2	800	-	1200	-
12.6	-	P1500	-	-
15.0	-	-	-	-
15.3	-	P1200	1000	-
16.0	600	-	-	2/0
18.3	-	P1000	800	-
19.7	500	-	-	0
20.0	-	-	-	-
21.8	-	P800	-	-
23.6	400	-	600	-
25.0	-	-	-	-
25.75	-	P600	-	-
28.8	360	-	500	-
30.0	-	P500	-	-
35.0	-	P400	400	-
36.0	320	-	-	-
40.0	-	-	360	-
40.5	-	P360	-	-
44.0	280	-	-	1
45.0	-	-	-	-
46.2	-	P320	320	-
50.0	-	-	-	-
52.5	-	P280	280	-
53.5	240	-	-	-
55.0	-	-	-	-
58.5	-	P240	-	-
60.0	-	-	240	-

BACKING TYPES

Backings are the base for the abrasive minerals and, combined with the adhesive bond, support and anchor the abrasive mineral. The backings used in the manufacture of coated abrasives are:

Paper: Paper is used for a variety of operations from hand sanding to mechanical sanding. It is the least expensive backing. Due to the fine surface of paper, a consistent finish is produced. Paper weights include A, B, C, D, E and F weights with A being the lightest and most flexible and F being the heaviest and least flexible. A, B, C and D weight papers are used for hand sanding and light mechanical operations in the form of sheets, Grip-On and Stick-On discs and Stick-On rolls. E and F weight papers are primarily used for more aggressive mechanical operations in the form of belts and discs.

Cloth: Cloth backings used for coated abrasives are identified by weight. Cloth backings are filled or “finished” with a variety of materials, glues or resins, to create various backing characteristics, most notably flexibility.

There are three basic weights of cloth: J-weight or “jeans” is the lightest and most flexible. X-weight or “drills” is a heavier cloth that ranges in flexibility, strength and durability and is used on the broadest range of applications. Y-weight is a heavyweight drills cloth used on heavy-duty, high stock removal operations. Several cloth types are used: cotton, polyester, and polyester/cotton blends.

Fiber: Vulcanized fiber (cotton fibers which are chemically treated and then pressed under temperature and pressure to form a very durable backing) is used exclusively as the backing for resin fiber discs.

BOND TYPES

An adhesive bond system is required to secure the abrasive mineral to the backing. All coated abrasive products are made with a two-stage bonding process. The first layer of bond applied to the backing is called the *make coat*. The make coat provides the adhesive base between the abrasive mineral and the backing.

AVERAGE PARTICLE SIZE IN MICRONS	GRADING SYSTEMS (OTHER THAN EMERY)			EMERY PRODUCTS
	CAMI	FEPA	JIS	
64.0	-	-	-	2
65.0	-	P220	220	-
66.0	220	-	-	-
78.0	180	P180	180	-
79.0	-	-	-	3
93.0	150	-	150	-
95.0	-	-	-	FINE
97.0	-	P150	-	-
116.0	120	-	120	-
127.0	-	P120	100	-
136.0	-	-	-	MEDIUM
141.0	100	-	-	-
156.0	-	P100	-	-
189.0	-	-	-	COARSE
192.0	80	-	80	-
197.0	-	P80	-	-
260.0	-	P60	-	-
268.0	60	-	60	-
326.0	-	P50	50	-
341.0	-	-	-	EX. COARSE
351.0	50	-	-	-
412.0	-	P40	40	-
428.0	40	-	-	-
524.0	-	P36	-	-
535.0	36	-	36	-
622.0	-	P30	-	-
638.0	30	-	30	-
715.0	24	-	-	-
740.0	-	P24	24	-
905.0	20	-	-	-
984.0	-	P20	20	-
1320.0	16	-	16	-
1324.0	-	P16	-	-
1764.0	-	P12	-	-
1842.0	12	-	-	-

BOND TYPES (CONTINUED)

The second coat is the *size coat*, which is applied over the abrasive mineral and make coat to anchor the abrasive mineral and provide the desired physical strength of the finished product.

Glue, urea resin, and phenolic resin are the three basic bonding agents most commonly used. There are many size coat and make coat combinations, such as glue over glue, urea over glue, and resin over resin. Glue over glue is the most flexible bond while resin over resin bond is moisture-resistant, harder, less flexible, heat-resistant and has superior grain retention.

COATING TYPES

There are two types of abrasive coatings used in the manufacturing of coated abrasives: open coat and closed coat.

Open Coat

With an open coat, 50% to 75% of the coated abrasive surface is covered by abrasive grain. There are evenly spaced voids between the particles of grain, helping reduce the effect of loading caused by wood dust or metal particles.



OPEN COAT
(1/3 LESS GRAIN THAN
CLOSED COAT)

Closed Coat

With a closed coat, the entire coated abrasive surface is covered with abrasive grain, with no voids between the particles. This is the most typical coating, permitting the greatest degree of stock removal and longest product life.



CLOSED COAT



COMPONENTS OF NON-WOVEN RIGHT ANGLE DISCS

Non-woven right angle discs have three components: strong synthetic fiber mesh and quality abrasives, bonded together by a smear-resistant adhesive. Surface Strip discs have an open web construction that enables aggressive cutting action while maintaining a cool, non-loading surface. Surface Prep discs have a more open weave that excels in preparation and cleaning of a surface. Each product provides excellent cutting action while improving surface finish.

The non-woven web is attached to a fiberglass backing plate (Surface Strip depressed center wheels) for direct mounting or onto a woven substrate backing (Surface Prep discs) for mounting on a rubber back-up pad.

WHY CHOOSE NON-WOVEN RIGHT ANGLE DISCS?

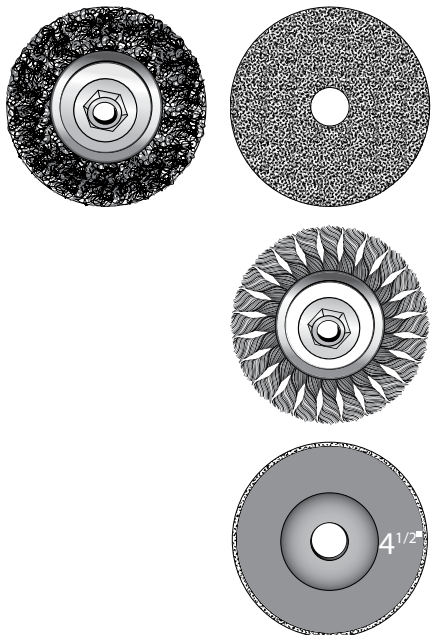

Non-Woven Right Angle Discs versus Fiber Discs, Wire Wheels, and Conventional Depressed Center Wheels

- Deburring, blending and finishing done with one product to reduce the number of steps
- To provide a controlled, sustained finish
- To prevent undercutting and gouging
- To provide a cooler grinding action to lessen the chance of warping or discoloration
- When loading is an issue with fiberglass, adhesives and soft metals
- For stripping coatings and paint off of hard materials like concrete, cement and stone
- Less vibration and quieter for high operator acceptance
- To provide a safe alternative to wire brushes

CARBO FIRE SURFACE STRIP NON-WOVEN DEPRESSED CENTER WHEELS

Best Tier / Ceramic Alumina



Extremely sharp and tough extra coarse ceramic grain blend and open construction make these wheels the best choice for quick and easy rough cleaning and stripping of all materials. Capable of material removal, blending and finishing.

FEATURES	BENEFITS
<ul style="list-style-type: none"> Ceramic alumina grain Advanced resin bond 	<ul style="list-style-type: none"> 2X cut rate, 2X life over silicon carbide Does not shed on rust encrusted pieces, and prevents gouging and rework Does not snag when used for deburring
<ul style="list-style-type: none"> New coating process 	<ul style="list-style-type: none"> Abrasive coating covers the entire disc providing a consistent cut rate
<ul style="list-style-type: none"> Open structure 	<ul style="list-style-type: none"> Sticky coatings, adhesives, and soft metals will not clog the disc

PART #	GRIT/ABRASIVE	COLOR	MAX. RPM	WHEELS/ CASE
4-1/2" x 5/8"-11				
05539500534	Extra Coarse Ceramic	Orange	12,000	5
4-1/2" x 7/8"				
05539500535	Extra Coarse Ceramic	Orange	12,000	10
7" x 5/8"-11				
05539500536	Extra Coarse Ceramic	Orange	8,000	5
7" x 7/8"				
05539500537	Extra Coarse Ceramic	Orange	8,000	10



SURFACE STRIP NON-WOVEN DEPRESSED CENTER WHEELS

Good Tier / Silicon Carbide



An open web construction quickly and easily cleans and conditions a multitude of materials, with very little loading. Excellent for removal of surface rust and residue, corrosion, light weld splatter, dirt, mill scale and other similar surface contaminants.

Major applications include:

- preparing surfaces before welding
- cleaning and conditioning after welding
- surface preparation before coatings are applied
- paint and epoxy coating removal

FEATURES	BENEFITS
<ul style="list-style-type: none"> Open web construction Extra coarse grit Thick and durable 	<ul style="list-style-type: none"> Smear resistant formula; resist loading Quick cleaning and conditioning of surfaces

PART #	GRIT/ABRASIVE	COLOR	MAX. RPM	WHEELS/ CASE
4-1/2" x 5/8"-11				
05539562616	Extra Coarse S/C	Black	12,000	10
4-1/2" x 7/8"				
05539562615	Extra Coarse S/C	Black	12,000	10
7" x 5/8"-11				
05539562618	Extra Coarse S/C	Black	8,000	10
7" x 7/8"				
05539562617	Extra Coarse S/C	Black	8,000	10



SURFACE BLEND VORTEX GRAIN TECHNOLOGY N-W DEPRESSED CENTER WHEELS

Best Tier / Vortex Aluminum Oxide



Can be used in place of, or in sequence with, fiber and flap discs, to clean, polish and impart great finishes in one or two operations. Engineered for heavy deburring and finishing a wide range of materials

FEATURES	BENEFITS
<ul style="list-style-type: none"> Proprietary Vortex aluminum oxide aggregate grain 	<ul style="list-style-type: none"> Aggressive, fast stock removal cut rate while providing a fine finish Twice the wheel life over conventional unified wheels, with minimal shedding
<ul style="list-style-type: none"> New bond technology 	<ul style="list-style-type: none"> Consistent performance with no smearing
<ul style="list-style-type: none"> Controlled porosity 	<ul style="list-style-type: none"> Cooler and improved cut rate

PART #	GRIT/ABRASIVE	COLOR	MAX. RPM	WHEELS/ CASE
4-1/2" x 5/8"-11				
05539500538	Medium Vortex A/O	Blue	12,000	10
4-1/2" x 7/8"				
05539500539	Medium Vortex A/O	Blue	12,000	10



SURFACE BLEND NON-WOVEN DEPRESSED CENTER WHEELS

Good Tier / Aluminum Oxide or Silicon Carbide



Can be used in place of, or in sequence with, fiber and flap discs, to clean, polish and impart great finishes in one or two operations. Surface Blend depressed center wheels will work anywhere our Surface Strip products work. Use Surface Blend wheels when a less aggressive product is needed.

Major applications include:

- prepping surfaces
- removing light scale on electrical power generation components (beryllium, copper, brass and bronze), composite and fiberglass resins, surface impurities from aluminum tubing, weld discoloration, over-spray from powder coating and painting operations
- cleaning and polishing injection molds, paper mill rolls, stainless steel, and ferrous and nonferrous metal surfaces

FEATURES	BENEFITS
<ul style="list-style-type: none"> Fine grain particle concentration cleans and polishes while imparting final finishes on a variety of materials 	<ul style="list-style-type: none"> Increases productivity and reduces total abrasive costs by eliminating a grinding step
<ul style="list-style-type: none"> Advanced resin system 	<ul style="list-style-type: none"> Resists loading: smear-free, clean, fine finishes
<ul style="list-style-type: none"> Low density 	<ul style="list-style-type: none"> Conformable and flexible
<ul style="list-style-type: none"> Undersized backing 	<ul style="list-style-type: none"> Maximizes grinding area and usage for longer life
<ul style="list-style-type: none"> CFX-2MA 	<ul style="list-style-type: none"> Most aggressive
<ul style="list-style-type: none"> CFX-2FA 	<ul style="list-style-type: none"> Multi-purpose
<ul style="list-style-type: none"> CFX-2FS 	<ul style="list-style-type: none"> Polishing
<ul style="list-style-type: none"> Medium A/O High Strength 	<ul style="list-style-type: none"> Less aggressive, most conformable

PART #	GRIT/ABRASIVE	COLOR	MAX. RPM	WHEELS/ CASE
4-1/2" x 5/8"-11				
66261023940	CFX-2MA	Tan	12,000	10
66261023910	CFX-2FA	Tan	12,000	10
66261023909	CFX-2FS	Grey	12,000	10
66261023942	Medium A/O High Strength	Maroon	12,000	10

PART #	GRIT/ABRASIVE	COLOR	MAX. RPM	WHEELS/ CASE
4-1/2" x 7/8"				
66261021754	CFX-2MA	Tan	12,000	10
66261021758	CFX-2FA	Tan	12,000	10
66261021750	CFX-2FS	Grey	12,000	10
66261021761	Medium A/O High Strength	Maroon	12,000	10



CARBO FIRE SURFACE STRIP NON-WOVEN DISCS

Best Tier / Ceramic Alumina



Rust-free alternative to a wire brush. These discs offer unmatched stripping power. Ideal for hard-to-reach areas. Rugged design provides long life and continuous cutting action to remove rust oxidation, and unwanted paint.

FEATURES	BENEFITS
<ul style="list-style-type: none"> Ceramic alumina grain Open web construction 	<ul style="list-style-type: none"> 2X cut rate, 2X life over silicon carbide Effective on sharp, jagged surfaces Great alternative to wire brushes Resist loading
<ul style="list-style-type: none"> Synthetic material web Thick and durable 	<ul style="list-style-type: none"> Will not rust Extended product life

PART #	GRIT/ABRASIVE	COLOR	MAX. RPM	WHEELS/CASE
3" TR				
66623329280	Extra Coarse Ceramic	Orange	12,000	10
4" TR +				
66623329282	Extra Coarse Ceramic	Orange	8,000	5
4" x 1/2" x 1/4" ARBOR HOLE				
77696039321	Extra Coarse Ceramic	Orange	8,000	25



See back-up pads and mandrel for these discs on page 111.

TR+ discs must be used with adapter, part number 77696061650 also on page 111.

SURFACE STRIP NON-WOVEN DISCS

Good Tier / Silicon Carbide



An open web construction quickly and easily cleans and conditions a multitude of materials, with very little loading. Excellent for removal of surface rust and residue, corrosion, light weld splatter, dirt, mill scale and other similar surface contaminants.

Major applications include:

- preparing surfaces before welding
- cleaning and conditioning after welding
- surface preparation before coatings are applied
- paint and epoxy coating removal

FEATURES	BENEFITS
<ul style="list-style-type: none"> Open web construction 	<ul style="list-style-type: none"> Smear resistant formula Resist loading
<ul style="list-style-type: none"> Extra coarse grit 	<ul style="list-style-type: none"> Quick cleaning and conditioning of surfaces
<ul style="list-style-type: none"> 2" and 3" discs with quick-change TR fastener 	<ul style="list-style-type: none"> Quick, tool-free disc changes allow more grinding time
<ul style="list-style-type: none"> 4" discs with quick-change TR+ fastener with longer TR shank 	<ul style="list-style-type: none"> Can be used on face and edge Quick-change replacement

PART #	GRIT/ABRASIVE	COLOR	MAX. RPM	DISCS/CASE
2" TR				
05539564097	Extra Coarse S/C	Black	15,500	10
3" TR				
05539564098	Extra Coarse S/C	Black	12,000	10
4" TR+				
05539573903	Extra Coarse S/C	Black	8,000	5

PART #	GRIT/ABRASIVE	COLOR	MAX. RPM	DISCS/CASE
4" x 1/2" x 1/4" ARBOR HOLE				
05539563438	Extra Coarse S/C	Black	8,000	25
4" x 1/2" x 3/8" ARBOR HOLE				
05539562614	Extra Coarse S/C	Black	8,000	25
4" x 1/2" x 1/2" ARBOR HOLE				
05539527164	Extra Coarse S/C	Black	8,000	25

See back-up pads and mandrel for these discs on page 111.

TR+ discs must be used with adapter, part number 77696061650 also on page 111.



BACK-UP PADS FOR NON-WOVEN QUICK-CHANGE TR DISCS

Accessory



TR (Type III) molded rubber pad with a 1/4" steel shank for quick mounting. Unique locking device on face provides convenience and quick change.

- Hard density pads are used for aggressive cutting action
- Medium density pads are used for all-purpose applications
- Soft density pads are used for contours and fine finishing work
- All quick-change back-up pads have a 1/4" diameter shank
- Refer to the end of the Coated Abrasive quick-change disc section for a complete list of back-up pads and mandrels.

PART #	DENSITY	MAX. RPM	PADS/CASE
2" TR			
08834164643	Hard	30,000	1
08834164922	Medium	30,000	1
08834164641	Soft	30,000	1
3" TR			
08834164036	Hard	20,000	1
08834164949	Medium	20,000	1
08834164644	Soft	20,000	1
4" TR+			
77696061650	Medium	8,000	10

E-ZVIEW FLEX-LOC SURFACE PREP NON-WOVEN DISCS

Good Tier / Aluminum Oxide



Allow operator to see surface being ground. Deliver a consistent finish when used to clean, deburr, blend or finish all types of metal and plastic. Ideal for the removal of rust, oxidation and coatings.

FEATURES	BENEFITS
<ul style="list-style-type: none"> • Non-woven web design 	<ul style="list-style-type: none"> • Conformable, controlled cutting action • Minimizes undercutting and gouging
<ul style="list-style-type: none"> • Advanced resin system • Round edge shape 	<ul style="list-style-type: none"> • Resists loading • Ideal for reaching into grooves, sharp edges, and hard-to-grind corners where work is done at a steeper angle
<ul style="list-style-type: none"> • Scooped holes 	<ul style="list-style-type: none"> • Allow operator to see the surface area being ground • Create air flow to remove swarf – preventing loading – and 30% cooler cutting action than conventional discs
<ul style="list-style-type: none"> • Flex-Loc mount • Aligned center-hole locking mechanism 	<ul style="list-style-type: none"> • Quick, tool-free changing of discs • Elimination of hole slippage or spinning • Discs are easily mounted and stay securely in place at all times.

PART #	GRIT/ABRASIVE	COLOR	DISCS/ CASE
4-1/2" x 7/8" E-ZVIEW FLEX-LOC			
05539554535	Extra Coarse A/O	Black	10
05539563955	Coarse A/O	Tan	10
05539563956	Medium A/O	Maroon	10
05539554536	Fine A/O	Green	10
05539563957	Very Fine A/O	Blue	40

PART #	GRIT/ABRASIVE	COLOR	DISCS/ CASE
7" x 7/8" E-ZVIEW FLEX-LOC			
05539554537	Medium A/O	Maroon	40



BACK-UP PADS FOR E-ZVIEW EDGER FLEX-LOC DISCS

Accessory



Designed exclusively for use with E-ZView Flex-Loc Discs. These back-up pads allow easy, tool-free mounting. The mounting hole and recessed lock-nut automatically line disc up with back-up pad and allow more disc to contact work surface.

PART #	DESCRIPTION	MAX. RPM	PADS/CASE
FOR E-ZVIEW EDGER FLEX-LOC DISCS			
05539563975	4-1/2" x 5/8"-11 Sawtooth	13,000	5
05539563836	7" x 5/8"-11 Round, Medium, Thicker	8,600	5



SURFACE PREP NON-WOVEN DISCS

Standard Tier / Aluminum Oxide



Good choice for light deburring and blending operation.

FEATURES	BENEFITS
<ul style="list-style-type: none"> • New Clean Bond resin system 	<ul style="list-style-type: none"> • Smear-free, even on high nickel content alloys • Will not load on aluminum and soft metals, as competitive products can
<ul style="list-style-type: none"> • Proprietary new coating method 	<ul style="list-style-type: none"> • Thick layer of grain throughout the product extends life; grain does not sit on top of fibers as on other competitive products
<ul style="list-style-type: none"> • Extended form holding 	<ul style="list-style-type: none"> • Lowers total cost of consumable tooling per workpiece
<ul style="list-style-type: none"> • Good choice for light deburring and blending operations 	<ul style="list-style-type: none"> • Provide better grain utility while remaining flexible

PART #	GRIT/ABRASIVE	COLOR	DISCS/ CASE
4-1/2" x 7/8" ARBOR HOLE			
05539554538	Extra Coarse A/O	Black	25
05539554539	Coarse A/O	Tan	25
05539554540	Medium A/O	Maroon	25
05539554541	Fine A/O	Green	25
05539554542	Very Fine A/O	Blue	25
5" x 7/8" ARBOR HOLE			
05539554543	Extra Coarse A/O	Black	25
05539554544	Coarse A/O	Tan	25
05539554545	Medium A/O	Maroon	25
05539554546	Fine A/O	Green	25
05539554547	Very Fine A/O	Blue	25
6" x 7/8" ARBOR HOLE			
05539554548	Extra Coarse A/O	Black	25
05539554549	Coarse A/O	Tan	25
05539554550	Medium A/O	Maroon	25
05539554551	Fine A/O	Green	25
05539554552	Very Fine A/O	Blue	25
7" x 7/8" ARBOR HOLE			
05539554553	Extra Coarse A/O	Black	25
05539554554	Coarse A/O	Tan	25
05539554555	Medium A/O	Maroon	25
05539554556	Fine A/O	Green	25
05539554557	Very Fine A/O	Blue	25

PART #	GRIT/ABRASIVE	COLOR	DISCS/ CASE
4-1/2" x 5/8"-11 SPEED-CHANGE			
05539554436	Coarse A/O	Tan	25
05539554437	Medium A/O	Maroon	25
05539554438	Very Fine A/O	Blue	25
5" x 5/8"-11 SPEED-CHANGE			
05539554439	Coarse A/O	Tan	25
05539554440	Medium A/O	Maroon	25
05539554441	Very Fine A/O	Blue	25
7" x 5/8"-11 SPEED-CHANGE			
05539554442	Coarse A/O	Tan	25
05539554443	Medium A/O	Maroon	25
05539554444	Very Fine A/O	Blue	25



BACK-UP PADS FOR NON-WOVEN DISCS

Accessory



Curved ribs on pad face reduce loading and allow for cooler cut. All air-cooled back up pads have a threaded 5/8-11" threaded female hub.

PART #	DIAMETER/DENSITY	MAX. RPM	STD. PKG.
FOR SURFACE PREP DISCS			
05539562582	4-1/2" Medium	11,000	5
05539512033	5" Medium	10,000	5
05539512032	7" Medium	8,600	5

SURFACE PREP HOOK & LOOP NON-WOVEN DISCS

Standard Tier / Aluminum Oxide



Good choice for light deburring and blending operation.

FEATURES	BENEFITS
<ul style="list-style-type: none"> • New Clean Bond resin system 	<ul style="list-style-type: none"> • Smear-free, even on high nickel content alloys • Will not load on aluminum and soft metals, as competitive products can
<ul style="list-style-type: none"> • Proprietary new coating method 	<ul style="list-style-type: none"> • Thick layer of grain throughout the product extends life; grain does not sit on top of fibers as on other competitive products
<ul style="list-style-type: none"> • Extended form holding 	<ul style="list-style-type: none"> • Lowers total cost of consumable tooling per workpiece
<ul style="list-style-type: none"> • Improved backing on hook and loop discs 	<ul style="list-style-type: none"> • Will not fly off rotary sanders • Discs sit flatter on back-up pads, resulting in a more consistent finish on DA applications
<ul style="list-style-type: none"> • Good choice for light deburring and blending operations 	<ul style="list-style-type: none"> • Provide better grain utility while remaining flexible

PART #	GRIT/ABRASIVE	COLOR	DISCS/ CASE
4-1/2"			
05539554558	Extra Coarse A/O	Black	25
05539554559	Coarse A/O	Tan	25
05539554560	Medium A/O	Maroon	25
05539554561	Fine A/O	Green	25
05539554562	Very Fine A/O	Blue	25
5"			
05539554416	Extra Coarse A/O	Black	25
05539554417	Coarse A/O	Tan	25
05539554418	Medium A/O	Maroon	25
05539554419	Fine A/O	Green	25
05539554420	Very Fine A/O	Blue	25
6"			
05539554421	Extra Coarse A/O	Black	25
05539554422	Coarse A/O	Tan	25
05539554423	Medium A/O	Maroon	25
05539554424	Fine A/O	Green	25
05539554425	Very Fine A/O	Blue	25

PART #	GRIT/ABRASIVE	COLOR	DISCS/ CASE
7"			
05539554426	Extra Coarse A/O	Black	25
05539554427	Coarse A/O	Tan	25
05539554428	Medium A/O	Maroon	25
05539554429	Fine A/O	Green	25
05539554430	Very Fine A/O	Blue	25
8"			
05539554431	Extra Coarse A/O	Black	25
05539554432	Coarse A/O	Tan	25
05539554433	Medium A/O	Maroon	25
05539554434	Fine A/O	Green	25
05539554435	Very Fine A/O	Blue	25



BACK-UP PADS FOR NON-WOVEN HOOK AND LOOP DISCS

Accessory



Hook and loop fastening system for neat, clean application and removal.

PART #	PAD DIAMETER	SPINDLE OR HOLE SIZE	MAX. RPM	STD. PKG.
FOR SURFACE PREP HOOK AND LOOP DISCS				
08834168025	2"	1/4" Steel Shank	23,000	1
08834168984	4"	5/8"-11 Thread	13,000	1
05539562718	4-1/2"	5/8"-11 Thread	10,000	5
08834168967	5"	5/8"-11 Thread	10,000	1
05539562723	6"	5/8"-11 Thread	8,000	5
08834168032	7"	5/8"-11 Thread	6,000	1



NON-WOVEN QUICK-CHANGE DISC COMPONENTS

Carborundum Surface Prep non-woven quick-change discs are a combination of strong synthetic mesh and quality abrasives, bonded together by a smear-resistant adhesive. They are ideal for use on portable tools to clean and remove surface imperfections, deburr, finish, blend weld seams, or create decorative finishes. The open construction of the non-woven material enables aggressive cutting action and improved surface finish while maintaining its non-loading feature.

QUICK-CHANGE ATTACHMENT SYSTEMS AND CROSS REFERENCE GUIDE

Enable quick, safe disc changes, reducing downtime and operating expenses.

Type TR (Type III)

- Features a roll-on/roll-off style fastener
- Fastener is made of nylon
- Equivalent to 3M™ Roloc™ fastening system



Type TS (Type II)

- Features a turn-on/turn-off style fastener
- Fastener is made of nylon
- Equivalent to Standard Abrasives' SocAtt® locking system



Type TP (Type I)

- Features a snap-on/snap-off style fastener
- Fastener is made of nylon



CARBORUNDUM	TYPE TR (TYPE III)	TYPE TS (TYPE II)	TYPE TP (TYPE I)
3M	Roloc TR	Roloc TS/TSM	Roloc TP
Standard	TR (Lockit)	TS (SocAtt)	TP (ClickOn)
Superior	Type R	Type S	–
Arc	Type R	Type S	Type P
Pferd	Type CDR	Type CD	–
Sait	SAIT-LOK-R	SAIT-LOK	–
Camel	Roll On	Turn On	–
Klingspor	QRC	QMC	–
Garryson	Type R	Type S	–

APPLICATION/GRIT RECOMMENDATION GUIDE

	MOST AGGRESSIVE				LEAST AGGRESSIVE		
	CARBO FIRE SURFACE STRIP	SURFACE STRIP	CARBO FIRE SURFACE BLEND	SURFACE BLEND	SURFACE PREP WITH VORTEX GRAIN TECHNOLOGY	SURFACE PREP	HS BUFFING, BUFFING
SCALE REMOVAL	BEST CHOICE	SECOND CHOICE					
STOCK REMOVAL	BEST CHOICE	SECOND CHOICE					
HEAVY DEBURRING		BEST CHOICE	SECOND CHOICE				
LIGHT DEBURRING			BEST CHOICE	SECOND CHOICE			
LIGHT FINISHING					BEST CHOICE	SECOND CHOICE	
BLENDING					BEST CHOICE	SECOND CHOICE	
CLEANING					SECOND CHOICE	BEST CHOICE	
FINISHING						BEST CHOICE	SECOND CHOICE

CROSS REFERENCE GUIDE

	STRIPPING	HEAVY/LIGHT DEBURRING	LIGHT DEBURRING/BLENDING/CLEANING/FINISHING	
CARBORUNDUM /MERIT	SURFACE STRIP	SURFACE BLEND	SURFACE PREP	HS BUFFING, BUFFING
3M	Clean & Strip, Clean Strip XT	EXL Unitized	Surf Cond, SL, SE	-
Standard	Cleaning Disc	500-900 Series Unitized	FE, GP, RC	Buff & Blend - HS, Buff & Blend
Fiberal/SIA		-	Meteor, Type B & C	-
Superior	Type R	XL Unitized	FD, GD, CC	HS, HD A/O
Arc	Arcstrip	-	Surface Cond	Blend & Finish
Pferd	Policlean	-	Finishing Disc - Hard & Soft	-
Sait	SAIT-Strip	-	HD, GP	Sand-Light Blending
Camel	EZ Strip - Black	-	-	-
Klingspor	Strip-It Black	-	-	-
Garryson		-	Surface Cond	-
Bibielle		BUR Unitized	DCR	-

ABRASIVE/GRIT/DENSITY KEY

ABRASIVE	SILICON CARBIDE	ALUMINUM OXIDE				CERAMIC
	SHARPER, FINER/BRIGHTER SCRATCH PATTERN					MORE DURABLE, LONGER LASTING, POLISHED FINISH
GRIT SIZE	XC (24-36)	C (50-80)	M (100-150)	F (180-220)	VF (240-360)	SF (400-600)
	FASTER, AGGRESSIVE CUT, ROUGHER FINISH				REDUCED CUT RATE, FINER FINISH	
DENSITY	2					9
	SOFT, OPEN, CONFORMABLE, LESS BURNING/LOADING				HARDER, MORE DURABLE, FASTER CUTTING, BETTER FINISH	

CARBO FIRE SURFACE BLEND NON-WOVEN QUICK-CHANGE DISCS

Best Tier / Ceramic Alumina



Best choice for deburring and blending applications

FEATURES	BENEFITS
<ul style="list-style-type: none"> Ceramic alumina grain 	<ul style="list-style-type: none"> Performs the extra coarse to medium grit steps of traditional surface conditioning discs in one operation
<ul style="list-style-type: none"> Special resin bond chemistry 	<ul style="list-style-type: none"> Resists shedding when used on sharp edges making these discs ideal for deburring No smearing
<ul style="list-style-type: none"> New erodable construction: abrasive is distributed throughout the entire disc (top, bottom, and sides) 	<ul style="list-style-type: none"> All three faces can be used – versus competitive discs' one bottom layer of abrasive 3 - 8 times the life of competitive surface blending discs Fewer safety, ergonomic, and environmental issues due to fewer changeouts, less downtime, and less production waste/landfill scrap

PART #	GRIT/ABRASIVE	MAX. RPM	STD. PKG.
TR (TYPE III)			
2" x 1/4" x TR			
05539500541	Coarse Ceramic	22,000	25
3" x 1/4" x TR			
05539500542	Coarse Ceramic	18,000	25

PART #	GRIT/ABRASIVE	MAX. RPM	STD. PKG.
TS (TYPE II)			
2" x 1/4" x TS			
05539500543	Coarse Ceramic	22,000	25
3" x 1/4" x TS			
05539500544	Coarse Ceramic	18,000	25

See quick-change back-up pads for these discs on page 121.



SURFACE BLEND VORTEX GRAIN TECHNOLOGY NON-WOVEN QUICK-CHANGE DISCS

Better Tier / Vortex Aluminum Oxide



Better choice for finishing and blending applications

FEATURES	BENEFITS
<ul style="list-style-type: none"> Proprietary Vortex aluminum oxide aggregate grain 	<ul style="list-style-type: none"> Performs the medium through fine grit steps of traditional discs in an easy one-step operation
<ul style="list-style-type: none"> Special resin bond chemistry 	<ul style="list-style-type: none"> Resists shedding when used on sharp edges, making these discs ideal for deburring No smearing
<ul style="list-style-type: none"> New erodable construction: abrasive is distributed throughout the entire disc (top, bottom and side) 	<ul style="list-style-type: none"> All three faces can be used – versus competitive discs' one bottom layer of abrasive 3 - 8 times the life of competitive surface blending discs Fewer safety, ergonomic, and environmental issues due to fewer change-outs, less downtime, and less production waste/landfill scrap

PART #	GRIT/ABRASIVE	MAX. RPM	STD. PKG.
TR (TYPE III)			
2" x 1/4" x TR			
05539500545	Medium Vortex A/O	22,000	25
3" x 1/4" x TR			
05539500546	Medium Vortex A/O	18,000	25

PART #	GRIT/ABRASIVE	MAX. RPM	STD. PKG.
TS (TYPE II)			
2" x 1/4" x TS			
05539500547	Medium Vortex A/O	22,000	25
3" x 1/4" x TS			
05539500548	Medium Vortex A/O	18,000	25

See quick-change back-up pads for these discs on page 121.





A good choice for moderate deburring and blending applications.

FEATURES	BENEFITS
<ul style="list-style-type: none"> High-performance abrasives bonded to high quality nylon fiber 	<ul style="list-style-type: none"> Aggressive, fast stock removal cut rate while providing a fine finish
<ul style="list-style-type: none"> Durable bond technology 	<ul style="list-style-type: none"> Consistent performance with hardness/flexibility
<ul style="list-style-type: none"> Smear-resistant resin formula 	<ul style="list-style-type: none"> Smear-free finish
<ul style="list-style-type: none"> Controlled porosity 	<ul style="list-style-type: none"> Uniform, cool cut rate for longer life

PART #	GRIT/ABRASIVE	DENSITY	MAX. RPM	STD. PKG.
TR (TYPE III)				
2" x 1/4" x TR				
66261054187	Coarse A/O	7-9	22,000	60
66261054183	Medium A/O	2-3	22,000	60
66261054185	Medium A/O	4-6	22,000	60
66261054186	Medium A/O	7-9	22,000	60
66261054182	Fine S/C	2-3	22,000	60
66261054184	Fine S/C	4-6	22,000	60

PART #	GRIT/ABRASIVE	DENSITY	MAX. RPM	STD. PKG.
TR (TYPE III)				
3" x 1/4" x TR				
66261054198	Coarse A/O	7-9	15,000	20
66261054193	Medium A/O	2-3	15,000	20
66261054196	Medium A/O	4-6	15,000	20
66261054197	Medium A/O	7-9	15,000	20
66261054192	Fine A/O	2-3	15,000	20
66261054194	Fine A/O	4-6	15,000	20
66261054195	Fine S/C	4-6	15,000	20

See quick-change back-up pads for these discs on page 121.



SURFACE PREP VORTEX GRAIN TECHNOLOGY NON-WOVEN QUICK-CHANGE DISCS

Better Tier / Vortex Aluminum Oxide



Best choice for finishing and blending applications

FEATURES	BENEFITS
<ul style="list-style-type: none"> Proprietary Vortex aluminum oxide aggregate grain 	<ul style="list-style-type: none"> Most consistent cutting and finishing of surface conditioning products on the market Combines fast cutting speed with the finish of finer grits Reduces process times by 50+% by combining multiple grit sequences to 1 step in a blending operation Friable grain structure keeps Ra specs throughout disc life and reduces scrap and rework
<ul style="list-style-type: none"> New, proprietary coating method 	<ul style="list-style-type: none"> More resistant to edge wear; up 4X life versus competitive products Thick layer of grain throughout the product extends life; grain does not sit on top of fibers as on other competitive products
<ul style="list-style-type: none"> New Clean Bond resin system 	<ul style="list-style-type: none"> Smear-free, even on high nickel content alloys Will not load on aluminum and soft metals, as competitive products can
<ul style="list-style-type: none"> Extended form holding 	<ul style="list-style-type: none"> Lowers total cost of consumable tooling per workpiece



PART #	GRIT/ABRASIVE	COLOR	DISCS/ CASE
TR (TYPE III)			
1"			
05539500471	Extra Coarse Vortex A/O	Black	50
05539500472	Coarse Vortex A/O	Tan	50
05539500473	Medium Vortex A/O	Maroon	50
05539500474	Fine Vortex A/O	Green	50
05539500475	Very Fine Vortex A/O	Blue	50
1-1/2"			
05539500476	Extra Coarse Vortex A/O	Black	50
05539500478	Coarse Vortex A/O	Tan	50
05539500479	Medium Vortex A/O	Maroon	50
05539500480	Fine Vortex A/O	Green	50
05539500481	Very Fine Vortex A/O	Blue	50

PART #	GRIT/ABRASIVE	COLOR	DISCS/ CASE
TR (TYPE III)			
2"			
05539500482	Extra Coarse Vortex A/O	Black	50
05539500483	Coarse Vortex A/O	Tan	50
05539500484	Medium Vortex A/O	Maroon	50
05539500485	Fine Vortex A/O	Green	50
05539500486	Very Fine Vortex A/O	Blue	50

See quick-change back-up pads for these discs on page 121.
Continued on next page.



PART #	GRIT/ABRASIVE	COLOR	DISCS/ CASE
TR (TYPE III) [CONTINUED]			
3"			
05539500488	Extra Coarse Vortex A/O	Black	50
05539500489	Coarse Vortex A/O	Tan	50
05539500490	Medium Vortex A/O	Maroon	50
05539500491	Fine Vortex A/O	Green	50
05539500492	Very Fine Vortex A/O	Blue	50

PART #	GRIT/ABRASIVE	COLOR	DISCS/ CASE
TR (TYPE III)			
4"			
05539500493	Extra Coarse Vortex A/O	Black	50
05539500494	Coarse Vortex A/O	Tan	50
05539500495	Medium Vortex A/O	Maroon	50
05539500497	Fine Vortex A/O	Green	50
05539500500	Very Fine Vortex A/O	Blue	50

PART #	GRIT/ABRASIVE	COLOR	DISCS/ CASE
TS (TYPE II)			
1"			
05539500501	Extra Coarse Vortex A/O	Black	50
05539500502	Coarse Vortex A/O	Tan	50
05539500503	Medium Vortex A/O	Maroon	50
05539500504	Fine Vortex A/O	Green	50
05539500505	Very Fine Vortex A/O	Blue	50
1-1/2"			
05539500506	Extra Coarse Vortex A/O	Black	50
05539500507	Coarse Vortex A/O	Tan	50
05539500508	Medium Vortex A/O	Maroon	50
05539500509	Fine Vortex A/O	Green	50
05539500515	Very Fine Vortex A/O	Blue	50
2"			
05539500516	Extra Coarse Vortex A/O	Black	50
05539500517	Coarse Vortex A/O	Tan	50
05539500518	Medium Vortex A/O	Maroon	50
05539500519	Fine Vortex A/O	Green	50
05539500520	Very Fine Vortex A/O	Blue	50

PART #	GRIT/ABRASIVE	COLOR	DISCS/ CASE
TS (TYPE II)			
3"			
05539500521	Extra Coarse Vortex A/O	Black	50
05539500522	Coarse Vortex A/O	Tan	50
05539500523	Medium Vortex A/O	Maroon	50
05539500524	Fine Vortex A/O	Green	50
05539500525	Very Fine Vortex A/O	Blue	50
4"			
05539500526	Extra Coarse Vortex A/O	Black	50
05539500527	Coarse Vortex A/O	Tan	50
05539500528	Medium Vortex A/O	Maroon	50
05539500529	Fine Vortex A/O	Green	50
05539500533	Very Fine Vortex A/O	Blue	50

See quick-change back-up pads for these discs on page 121.



SURFACE PREP NON-WOVEN QUICK-CHANGE DISCS

Good Tier / Aluminum Oxide



Good choice for finishing and blending applications.

FEATURES	BENEFITS
<ul style="list-style-type: none"> • New Clean Bond resin system • Proprietary new coating method 	<ul style="list-style-type: none"> • Smear-free, even on high nickel content alloys • Will not load on aluminum and soft metals, as competitive products may • Thick layer of grain throughout the product extends life; grain does not sit on top of fibers as on other competitive products

PART #	GRIT/ABRASIVE	COLOR	DISCS/ CASE
TR (TYPE III)			
1"			
05539554521	Extra Coarse A/O	Black	50
05539554523	Coarse A/O	Tan	50
05539554445	Medium A/O	Maroon	50
05539554447	Fine A/O	Green	50
05539554449	Very Fine A/O	Blue	50
1-1/2"			
05539554451	Extra Coarse A/O	Black	50
05539554453	Coarse A/O	Tan	50
05539554455	Medium A/O	Maroon	50
05539554457	Fine A/O	Green	50
05539554459	Very Fine A/O	Blue	50
2"			
05539554461	Extra Coarse A/O	Black	50
05539554463	Coarse A/O	Tan	50
05539554465	Medium A/O	Maroon	50
05539554467	Fine A/O	Green	50
05539554469	Very Fine A/O	Blue	50

PART #	GRIT/ABRASIVE	COLOR	DISCS/ CASE
TR (TYPE III)			
3"			
05539554525	Extra Coarse A/O	Black	25
05539554527	Coarse A/O	Tan	25
05539554529	Medium A/O	Maroon	25
05539554531	Fine A/O	Green	25
05539554533	Very Fine A/O	Blue	25
4"			
05539554563	Extra Coarse A/O	Black	25
05539554565	Coarse A/O	Tan	25
05539554472	Medium A/O	Maroon	25
05539554567	Fine A/O	Green	25
05539554569	Very Fine A/O	Blue	25

See quick-change back-up pads for these discs on page 121.

Continued on next page.



PART #	GRIT/ABRASIVE	COLOR	DISCS/ CASE
TS (TYPE II)			
1"			
05539554522	Extra Coarse A/O	Black	50
05539554524	Coarse A/O	Tan	50
05539554446	Medium A/O	Maroon	50
05539554448	Fine A/O	Green	50
05539554450	Very Fine A/O	Blue	50
1-1/2"			
05539554452	Extra Coarse A/O	Black	50
05539554454	Coarse A/O	Tan	50
05539554456	Medium A/O	Maroon	50
05539554458	Fine A/O	Green	50
05539554460	Very Fine A/O	Blue	50
2"			
05539554462	Extra Coarse A/O	Black	50
05539554464	Coarse A/O	Tan	50
05539554466	Medium A/O	Maroon	50
05539554468	Fine A/O	Green	50
05539554470	Very Fine A/O	Blue	50
3"			
05539554526	Extra Coarse A/O	Black	25
05539554528	Coarse A/O	Tan	25
05539554530	Medium A/O	Maroon	25
05539554532	Fine A/O	Green	25
05539554534	Very Fine A/O	Blue	25
4"			
05539554564	Extra Coarse A/O	Black	25
05539554471	Coarse A/O	Tan	25
05539554566	Medium A/O	Maroon	25
05539554568	Fine A/O	Green	25
05539554570	Very Fine A/O	Blue	25

PART #	GRIT/ABRASIVE	COLOR	DISCS/ CASE
TP (TYPE I)			
1-1/2"			
05539554586	Coarse A/O	Tan	50
05539554587	Medium A/O	Maroon	50
05539554588	Very Fine A/O	Blue	50
2"			
05539554589	Coarse A/O	Tan	50
05539554590	Medium A/O	Maroon	50
05539554591	Very Fine A/O	Blue	50
3"			
05539554592	Coarse A/O	Tan	25
05539554593	Medium A/O	Maroon	25
05539554594	Very Fine A/O	Blue	25

See quick-change back-up pads for these discs on page 121.



MERIT HIGH STRENGTH NON-WOVEN BUFFING/POLISHING QUICK-CHANGE DISCS



Better Tier / Aluminum Oxide



Tough, yet conformable, high-strength discs are smear-proof and resist tearing on burrs and sharp edges.

FEATURES	BENEFITS
<ul style="list-style-type: none"> A non-woven nylon fiber impregnated with abrasive and laminated to a quick-change nylon backing 	<ul style="list-style-type: none"> Superior button adhesion to prevent disc fly-offs at higher grinding speeds Produce a consistently uniform finish Longer lasting

PART #	GRIT/ABRASIVE	STD. PKG.
TR (TYPE III)		
2"		
08834164064	Medium A/O	50
08834163987	Very Fine A/O	50
3"		
08834164065	Medium A/O	25
08834163559	Very Fine A/O	25

PART #	GRIT/ABRASIVE	STD. PKG.
TS (TYPE II)		
2"		
08834164244	Medium A/O	50
08834164245	Very Fine A/O	50
3"		
08834164252	Medium A/O	25
08834164255	Very Fine A/O	25

See quick-change back-up pads for these discs on page 121.





This product incorporates high-performance fiber blends with flexible resin technology. Designed for light removal of paint or rust without affecting the base product.

FEATURES	BENEFITS
<ul style="list-style-type: none"> A non-woven nylon fiber impregnated with abrasive and laminated to a quick-change nylon backing 	<ul style="list-style-type: none"> Superior button adhesion to prevent disc fly-offs at higher grinding speeds Produce a consistently uniform finish

PART #	GRIT/ABRASIVE	STD. PKG.
TR (TYPE III)		
1-1/2"		
08834161647	Coarse A/O	100
08834166368	Medium A/O	100
08834166369	Fine A/O	100
08834166417	Very Fine A/O	100
2"		
08834161649	Coarse A/O	50
08834166303	Medium A/O	50
08834166304	Fine A/O	50
08834166305	Very Fine A/O	50
3"		
08834161651	Coarse A/O	25
08834166308	Medium A/O	25
08834166309	Fine A/O	25
08834166310	Very Fine A/O	25
4"		
08834161654	Coarse A/O	25
08834166314	Medium A/O	25
08834166315	Fine A/O	25
08834166316	Very Fine A/O	25

PART #	GRIT/ABRASIVE	STD. PKG.
TS (TYPE II)		
1-1/2"		
08834166391	Coarse A/O	100
08834166392	Medium A/O	100
08834166393	Fine A/O	100
08834166406	Very Fine A/O	100
2"		
08834166394	Coarse A/O	50
08834166395	Medium A/O	50
08834166396	Fine A/O	50
08834166405	Very Fine A/O	50
3"		
08834166397	Coarse A/O	25
08834166398	Medium A/O	25
08834166399	Fine A/O	25
08834166403	Very Fine A/O	25
4"		
08834166400	Coarse A/O	25
08834166401	Medium A/O	25
08834166402	Fine A/O	25
08834166404	Very Fine A/O	25

PART #	GRIT/ABRASIVE	STD. PKG.
TP (TYPE I)		
1-1/2"		
08834166294	Coarse A/O	100
08834166292	Medium A/O	100
08834166332	Fine A/O	100
08834166333	Very Fine A/O	100
2"		
08834161627	Coarse A/O	50
08834166280	Medium A/O	50
08834166281	Fine A/O	50
08834166282	Very Fine A/O	50
3"		
08834166293	Coarse A/O	25
08834166284	Medium A/O	25
08834166285	Fine A/O	25
08834166286	Very Fine A/O	25
4"		
08834166295	Medium A/O	25
08834166296	Fine A/O	25
08834166297	Very Fine A/O	25



BACK-UP PADS FOR QUICK-CHANGE DISCS

Accessory



- Hard density pads are used for aggressive cutting action
- Medium density pads are used for all-purpose applications
- Soft density pads are used for contours and fine finishing work
- All quick-change back-up pads have a 1/4" diameter shank
- Standard package for quick-change back-up pads is 1
- Refer to the end of the Coated Abrasive quick-change disc section for a complete list of back-up pads and mandrels.



TR (TYPE III)

PART #	DIA.	MAX. RPM	DENSITY
TR (TYPE III) ATTACHMENT			
08834164037	1"	40,000	Medium
08834164640	1-1/2"	30,000	Hard
08834161174			Medium
08834164643	2"	30,000	Hard
08834164922			Medium
08834164641			Soft
08834164036	3"	20,000	Hard
08834164949			Medium
08834164644			Soft
08834164655	4"	15,000	Medium



TS (TYPE II)

PART #	DIA.	MAX. RPM	DENSITY
TS (TYPE II) ATTACHMENT			
08834164651	1"	40,000	Medium
08834164622	1-1/2"	30,000	Hard
08834164146			Medium
08834164624	2"	30,000	Hard
08834164198			Medium
08834161625			Soft
08834161626	3"	20,000	Hard
08834164113			Medium
08834164626			Soft
08834164135	4"	15,000	Medium



TP (TYPE I)

PART #	DIA.	MAX. RPM	DENSITY
TP (TYPE I) ATTACHMENT			
08834164002	1"	40,000	Medium
08834163996	1-1/2"	30,000	Hard
08834164003			Medium
08834163997	2"	30,000	Hard
08834164004			Medium
08834163949			Soft
08834163998	3"	20,000	Hard
08834164005			Medium
08834163948			Soft
08834164006	4"	15,000	Medium



Good choice for ID cleaning, finishing and polishing.

FEATURES	BENEFITS
<ul style="list-style-type: none"> • Unique shape for ID work 	<ul style="list-style-type: none"> • Flexible star shape penetrates the ID and polishes or cleans the surface without disturbing any tolerances
<ul style="list-style-type: none"> • 1/4"-20 eyelets 	<ul style="list-style-type: none"> • Easy to mount to standard 1/4"-20 threaded mandrels
<ul style="list-style-type: none"> • Proprietary Clean Bond resin system 	<ul style="list-style-type: none"> • Provides a clean, smear-free finish
<ul style="list-style-type: none"> • High-performance aluminum oxide abrasive 	<ul style="list-style-type: none"> • Provides consistent cutting and surface finishes

PART #	GRIT/ABRASIVE	STD. PKG.
1-1/2" x 1/4"-20 EYELET		
08834185923	Coarse A/O	100
08834185924	Medium A/O	100
08834185925	Very Fine A/O	100
2" x 1/4"-20 EYELET		
08834185926	Coarse A/O	100
08834185927	Medium A/O	100
08834185298	Very Fine A/O	100

PART #	GRIT/ABRASIVE	STD. PKG.
3" x 1/4"-20 EYELET		
08834185929	Coarse A/O	100
08834185678	Medium A/O	100
08834185931	Very Fine A/O	100
4" x 1/4"-20 EYELET		
08834185932	Coarse A/O	100
08834185933	Medium A/O	100
08834185934	Very Fine A/O	100



QUICK-CHANGE MANDREL FOR 1/4"-20 EYELET PRODUCTS

Accessory



Designed for use with surface preparation stars.

PART #	MODEL #	OVERALL LENGTH	THREAD SIZE
08834183164	MM20-4	3"	1/4-20

APPLICATION RECOMMENDATION GUIDE

COARSER ACTING
FOR CLEANING
AND DEBURRING



FINER ACTING
FOR LIGHT SCUFFING
AND BLENDING

Brown – 05539574000

A heavy-duty, medium grit aluminum oxide pad for aggressive action where a stiffer, coarser pad is required.

Gray – 05539574600

A medium grit, silicon carbide pad, with an open web structure primarily used for all types of blending applications, especially on stainless steel.

Green – 05539579600

A very fine grit aluminum oxide pad for general clean-up as well as finishing stainless steel.

Maroon – 05539577700

A very fine grit, aluminum oxide pad with a fast cut rate for cleaning, deburring, and corrosion and oxidation removal.

Maroon – 05539574700 / 05539584700

Very fine, aluminum oxide pads for general cleaning and finishing, removal of rust and oxidation from metals, and lightly sanding old paint or new primers. No color bleeding when working with solvents. 84700 is perforated to create two smaller 4-1/2" x 6" pads.

Light Green – 05539569600

A very fine grit, aluminum oxide pad for general purpose cleaning in food processing plants and sanitary preparations.

Gray – 05539563500

An ultra fine grit, silicon carbide pad for denubbing between finish coats, as well as lacquer rubbing.

Gray – 05539574800

A micro fine grit, silicon carbide pad for light cleaning steel and non-steel, defuzzing wood and final rubbing. Softer acting, more flexible. Consistent, finer finishes.

White – 05539545600

For general clean-up, light primer rub down and paint overspray removal. Softer acting, more flexible. Non-abrasive.

FIBRATEX NON-WOVEN HAND PADS

Good Tier / Aluminum Oxide, Silicon Carbide, or Non-Abrasive

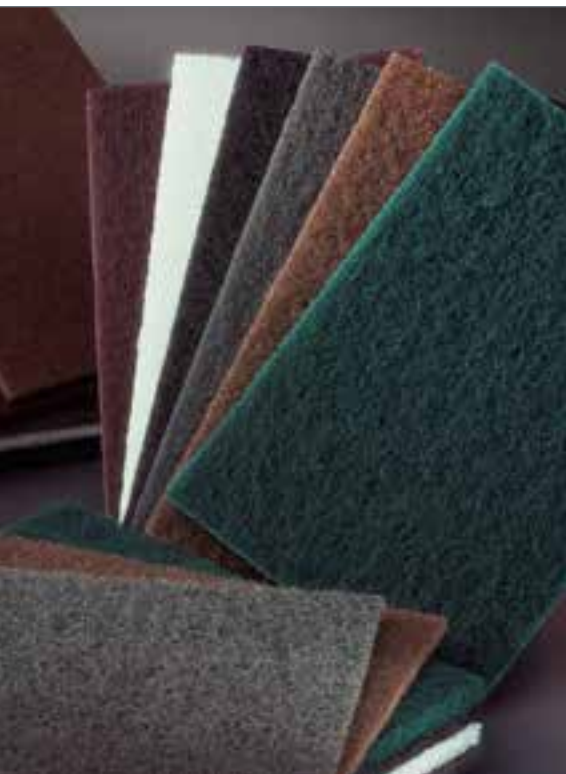

Fibratex products are a non-woven nylon web impregnated with abrasive grain and resin bond. They are non-metallic, won't rust, and are ideal as replacements for steel wool and/or wire brushes.

FEATURES	BENEFITS
<ul style="list-style-type: none"> Non-woven nylon, impregnated with abrasive grain 	<ul style="list-style-type: none"> Excellent conformability and flexibility Easy to fold Long lasting and high resistance to tearing
<ul style="list-style-type: none"> Numerous specifications 	<ul style="list-style-type: none"> Replacement for steel wool and wire brushes

PART #	GRIT/ABRASIVE	COLOR	TIER	PADS/ CASE
6" x 9"				
05539574000	Medium A/O	Brown	GOOD	40
05539574600	Medium S/C	Gray	GOOD	40
05539579600	VF A/O Scouring	Green	GOOD	60
05539577700	Very Fine A/O Long Life	Maroon	GOOD	60
05539574700	Very Fine A/O Gen. Purp.	Maroon	BETTER	60
05539584700	VF A/O G/P Perforated	Maroon	BETTER	60
05539569600	VF A/O Food Pro	Lt. Green	GOOD	60
05539563500	Ultra Fine S/C	Gray	GOOD	60
05539574800	Micro Fine S/C	Gray	GOOD	60
05539545600	Non-Abrasive	White	GOOD	60
PART #	DESCRIPTION	HOLDERS/ CASE		
HAND PAD HOLDER				
05539562709	Hand Pad Holder	10		



FIBRATEX THIN & FLEXIBLE HIGH PERFORMANCE HAND PADS

Better Tier / Aluminum Oxide or Silicon Carbide



For cleaning, blending, finishing, and deburring in wood working, metalworking, maintenance operations, and synthetics fabrication.

FEATURES	BENEFITS
<ul style="list-style-type: none"> • Superior flexibility 	<ul style="list-style-type: none"> • Conforms to a workpiece for a consistent finish
<ul style="list-style-type: none"> • Advanced web design 	<ul style="list-style-type: none"> • Cuts quicker than standard hand pad



PART #	GRIT/ABRASIVE	COLOR	PADS/CASE
4-1/2" x 9"			
05539554859	Very Fine Aluminum Oxide	Maroon	25
05539554860	Ultra Fine Silicon Carbide	Grey	25



FIBRATEX NON-WOVEN ROLLS

Good Tier / Aluminum Oxide, Silicon Carbide, or Non-Abrasive



An economical alternative to cut pads; can be cut to specific size needed for hand sanding applications.

FEATURES	BENEFITS
<ul style="list-style-type: none"> • Premium aluminum oxide and silicon carbide grains available in wide variety of grit sizes 	<ul style="list-style-type: none"> • Clean cutting
<ul style="list-style-type: none"> • Durable web; strong resin binders 	<ul style="list-style-type: none"> • Long lasting and high resistance to tearing on burrs and sharp edges
<ul style="list-style-type: none"> • Uniform web construction 	<ul style="list-style-type: none"> • Consistent surface finish
<ul style="list-style-type: none"> • Can be cut to exact sizes needed 	<ul style="list-style-type: none"> • Economical; minimal waste



PART #	DESCRIPTION	ABRASIVE	GRIT SIZE	COLOR	TIER	ROLLS/CASE
4" x 30 FEET						
05539554571	General Purpose	A/O	Fine	Maroon	GOOD	4
05539554572	Fast Cut	A/O	VF	Maroon	GOOD	4
05539554573	Scouring	A/O	VF	Green	GOOD	5
05539554574	High Strength	A/O	VF	Maroon	BETTER	3
05539554575	General Cleaning	S/C	VF	Gray	GOOD	3
05539554576	Clean & Finish	S/C	UF	Gray	GOOD	5
05539554577	Finishing	S/C	MF	Gray	GOOD	5
05539554578	T-Polishing	None	Non	White	GOOD	3
6" x 30 FEET						
05539554579	High Strength	A/O	Med	Maroon	BETTER	2
05539554580	General Cleaning	S/C	VF	Gray	GOOD	3
05539554581	Clean & Finish	S/C	UF	Gray	GOOD	3
05539554582	Fast Cut	A/O	UF	Maroon	GOOD	3
05539554583	High Strength	A/O	MF	Maroon	BETTER	2



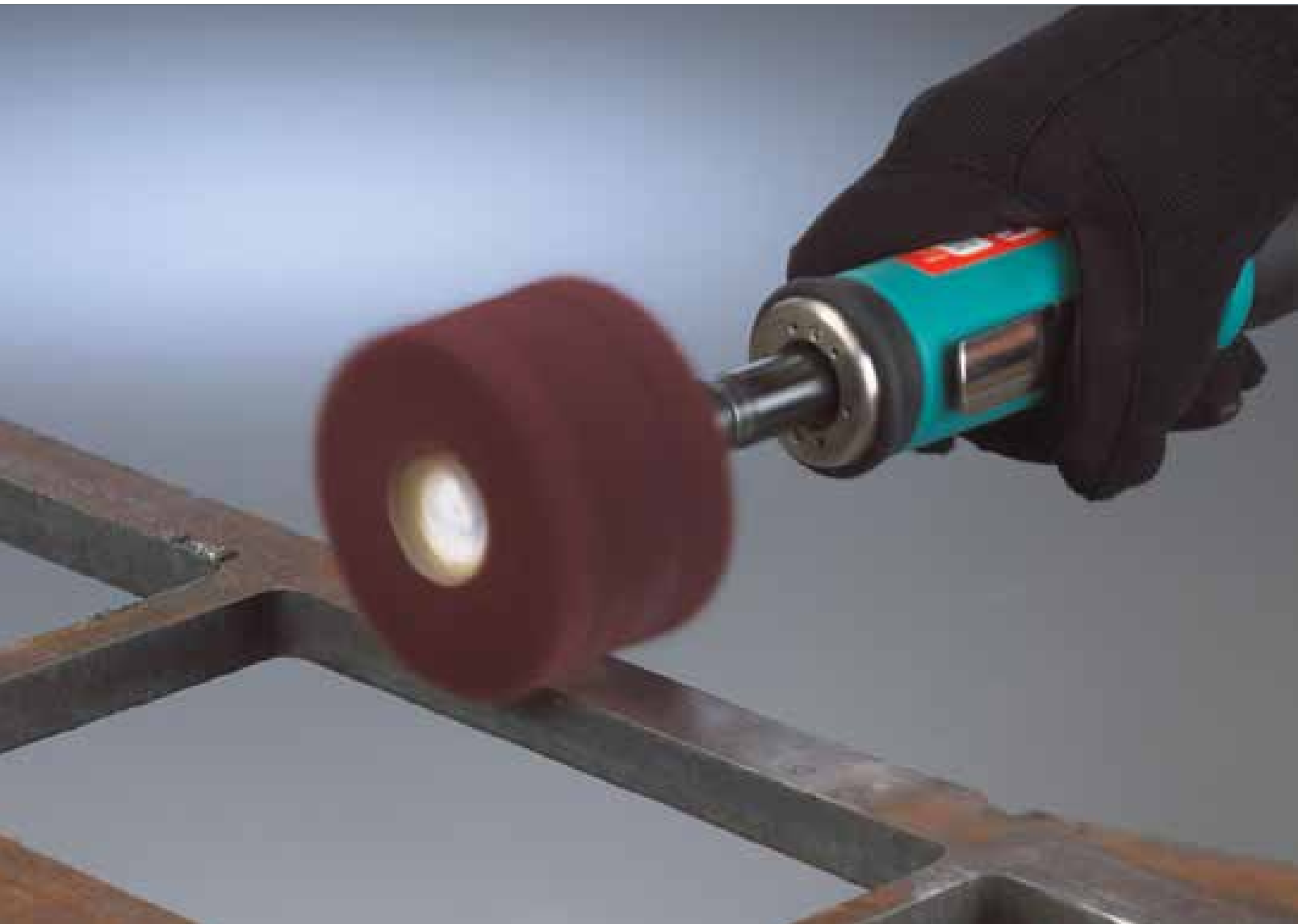

NON-WOVEN FLAP WHEELS

Non-woven surface finishing flap wheels are an ideal choice for a wide variety of blending and finishing applications common in the metal fabrication, welding and polishing industries. Flap wheels are conformable to intricate shapes and contours. Designed to deliver a consistent finish with a uniform rate of cut, flap wheels wear away continually exposing fresh abrasives.

There are two types of non-woven flap wheels: non-woven only abrasive flaps where finishing is the primary application, and interleaf with alternating cloth and non-woven abrasive flaps (less conformable, more aggressive) for stock removal and finishing. Interleaf flap wheels must always be run in the direction indicated by the arrow.

APPLICATION/GRIT RECOMMENDATION GUIDE

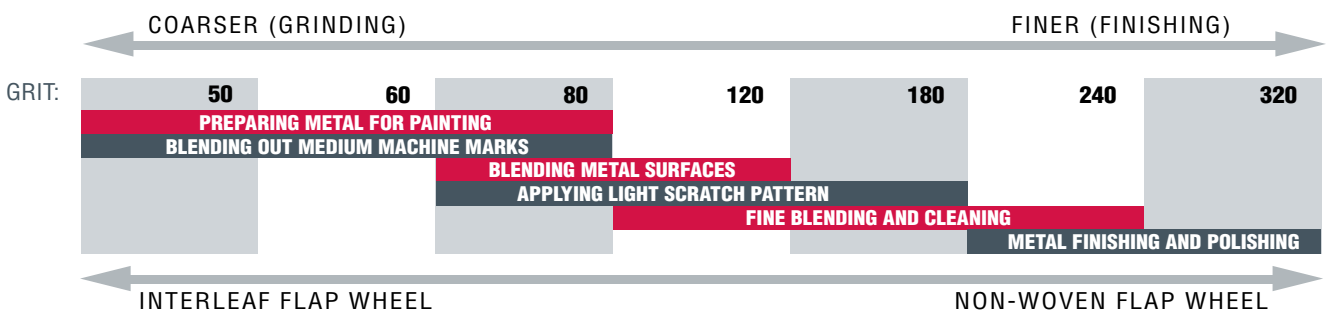

MERIT NON-WOVEN FLAP WHEELS WITH 1/4" MOUNTED STEEL SHANKS



Good Tier / Aluminum Oxide



Used for a wide range of metal fabrication and welding applications including blending, deburring, cleaning, finishing, and polishing. Use non-woven flap wheels where finishing is the primary application.

FEATURES	BENEFITS
<ul style="list-style-type: none"> • Flexible and conformable 	<ul style="list-style-type: none"> • Eliminate gouging • Consistent surface finish on uneven or irregular surfaces as well as flat areas
<ul style="list-style-type: none"> • Premium abrasive grains 	<ul style="list-style-type: none"> • Quick cutting and finishing action

PART #	NON-WOVEN GRIT/ABRASIVE	MAX. RPM	STD. PKG.
2" x 1" x 1/4"			
66261189992	Medium A/O	12,000	20
69957399202	Very Fine A/O	12,000	20
3" x 1" x 1/4"			
08834131921	Medium A/O	12,000	10
66261189993	Very Fine A/O	12,000	10



MERIT N-W INTERLEAF FLAP WHEELS WITH 1/4" MOUNTED STEEL SHANKS



Good Tier / Aluminum Oxide



Interleaf flap wheels, with alternating cloth and non-woven abrasive flaps, are less conformable, and more aggressive for stock removal and finishing. Interleaf flap wheels must always be run in the direction indicated by the arrow.

FEATURES	BENEFITS
<ul style="list-style-type: none"> • Consist of alternating flaps of aluminum oxide coated abrasive cloth and medium grit non-woven material 	<ul style="list-style-type: none"> • Produce a finer finish • Eliminate chatter at slow speeds
<ul style="list-style-type: none"> • More aggressive than a standard non-woven flap wheel 	<ul style="list-style-type: none"> • Remove more material

PART #	COATED ABRASIVE GRIT	NON-WOVEN GRIT	ABRASIVE	MAX. RPM	STD. PKG.
2" x 1" x 1/4"					
08834138122	60	Coarse	A/O	12,000	10
08834138123	80	Medium	A/O	12,000	10
08834144457	120	Medium	A/O	12,000	10
08834144458	180	Fine	A/O	12,000	10
08834144459	320	Very Fine	A/O	12,000	10
2" x 1-1/2" x 1/4"					
08834138125	80	Medium	A/O	12,000	10
08834138126	120	Medium	A/O	12,000	10
3" x 1" x 1/4"					
08834138129	60	Coarse	A/O	12,000	10
08834138130	80	Medium	A/O	12,000	10
08834138118	120	Medium	A/O	12,000	10
08834138120	180	Fine	A/O	12,000	10
08834138119	320	Very Fine	A/O	12,000	10
3" x 2" x 1/4"					
08834144460	120	Medium	A/O	8,000	10
08834144461	180	Medium	A/O	8,000	10
4" x 2" x 1/4"					
08834121115	80	Coarse	A/O	12,000	10
08834120458	120	Medium	A/O	12,000	10



MERIT NON-WOVEN FLAP WHEELS WITH ARBOR HOLES



Good Tier / Aluminum Oxide or Silicon Carbide



Used for a wide range of metal fabrication and welding applications including blending, deburring, cleaning, finishing, and polishing. Use non-woven flap wheels where finishing is the primary application.

FEATURES	BENEFITS
<ul style="list-style-type: none"> Flexible and conformable 	<ul style="list-style-type: none"> Eliminate gouging Consistent surface finish on uneven or irregular surfaces as well as flat areas
<ul style="list-style-type: none"> Premium abrasive grains 	<ul style="list-style-type: none"> Quick cutting and finishing action

PART #	NON-WOVEN GRIT/ABRASIVE	MAX. RPM	STD. PKG.
6" x 1" x 2"			
05539512667	Medium A/O	3,000	4
05539512658	Very Fine S/C	3,000	4
8" x 1" x 3"			
05539527460	Fine A/O	2,500	3
8" x 2" x 3"			
05539512677	Medium A/O	2,500	2
05539526627	Fine A/O	2,500	2
12" x 2" x 5"			
05539562637	Medium High Strength A/O	1,900	1



MERIT NON-WOVEN INTERLEAF FLAP WHEELS WITH ARBOR HOLES



Good Tier / Aluminum Oxide



Interleaf flap wheels, with alternating cloth and non-woven abrasive flaps, are less conformable, and more aggressive for stock removal and finishing. Interleaf flap wheels must always be run in the direction indicated by the arrow.

FEATURES	BENEFITS
<ul style="list-style-type: none"> Consist of alternating flaps of aluminum oxide coated abrasive cloth and medium grit non-woven material 	<ul style="list-style-type: none"> Produce a finer finish Eliminate chatter at slow speeds
<ul style="list-style-type: none"> More aggressive than a standard non-woven flap wheel 	<ul style="list-style-type: none"> Remove more material

PART #	COATED ABRASIVE GRIT	NON-WOVEN GRIT	ABRASIVE	MAX. RPM	STD. PKG.
6" x 1" x 1"					
08834126028	50	Coarse	A/O	6,000	10
08834126006	120	Medium	A/O	6,000	10
08834126030	240	Very Fine	A/O	6,000	10



REDUCING BUSHINGS FOR CONVOLUTE AND FLAP WHEELS WITH ARBOR HOLES

Accessory



A set of reducing bushings will be included at no charge, for 6" diameter convolute wheels and flap wheels, when ordered with the wheels and specified on the order.

PART #	WHEEL CENTER HOLE	BUSHING REDUCES TO ARBOR SIZE	PAIRS/BOX
REDUCING BUSHINGS			
66261080527	2	from 2" to 1/2" Wheels 6" diameter	1
66261080528	2	from 2" to 5/8" Wheels 6" diameter	1
66261080529	2	from 2" to 1" Wheels 6" diameter	1
66261080530	2	from 2" to 1-1/4" Wheels 6" diameter	1
66261080531	3	from 3" to 1" Wheels 8" diameter	1
66261080532	3	from 3" to 1-1/4" Wheels 8" diameter	1
66261080383	3	from 3" to 1-1/2" Wheels 8" diameter	1
66261080384	3	from 3" to 1-3/4" Wheels 8" diameter	1
66261080514	3	from 3" to 2" Wheels 8" diameter	1

Wheel center hole is equal to the bushing outside diameter. Order by number of pairs. (Example: 3 = 3 Pairs which = 6 bushings)

APPLICATION/GRIT RECOMMENDATION GUIDE

Carborundum non-woven belts are a combination of strong synthetic mesh and quality abrasive, bonded together by a smear-resistant adhesive. The open construction of non-woven material enables aggressive cutting action and improved surface finish while maintaining its non-loading feature.

	COARSE	MEDIUM	VERY FINE
Stock Removal	X		
Heavy Deburring	X		
Light Deburring		X	
Light Finishing		X	
Finishing			X

SURFACE PREP NON-WOVEN BELTS

Good Tier / Aluminum Oxide



Good choice for finishing and blending applications, such as removing surface defects, light edge burrs, parting lines, flashing, rust, oxides, corrosion, paints; blending mill marks, tool marks, uneven edges, and applying decorative finishes.

FEATURES	BENEFITS
<ul style="list-style-type: none"> • New Clean Bond resin system 	<ul style="list-style-type: none"> • Smear-free, even on high nickel content alloys • Will not load on aluminum and soft metals, as competitive products can
<ul style="list-style-type: none"> • Proprietary new coating method 	<ul style="list-style-type: none"> • Thick layer of grain throughout the product extends life; grain does not sit on top of fibers as on other competitive products
<ul style="list-style-type: none"> • Extended form holding 	<ul style="list-style-type: none"> • Lowers total cost of consumable tooling per workpiece

PART #	GRIT/ABRASIVE	COLOR	STD. PKG.
1/4" x 18"			
05539554473	Coarse A/O	Brown	12
05539554474	Medium A/O	Maroon	12
05539554475	Very Fine A/O	Blue	12
1/4" x 24"			
05539554476	Coarse A/O	Brown	12
05539554477	Medium A/O	Maroon	12
05539554478	Very Fine A/O	Blue	12
1/2" x 18"			
05539554479	Coarse A/O	Brown	12
05539554480	Medium A/O	Maroon	12
05539554481	Very Fine A/O	Blue	12
1/2" x 24"			
05539554482	Coarse A/O	Brown	12
05539554483	Medium A/O	Maroon	12
05539554484	Very Fine A/O	Blue	12
3/4" x 18"			
05539554485	Coarse A/O	Brown	12
05539554486	Medium A/O	Maroon	12
05539554487	Very Fine A/O	Blue	12
3/4" x 20-1/2"			
05539554488	Coarse A/O	Brown	12
05539554489	Medium A/O	Maroon	12
05539554490	Very Fine A/O	Blue	12
1" x 42"			
05539554491	Coarse A/O	Brown	12
05539554492	Medium A/O	Maroon	12
05539554493	Very Fine A/O	Blue	12
1" x 60"			
05539554494	Coarse A/O	Brown	12
05539554495	Medium A/O	Maroon	12
05539554496	Very Fine A/O	Blue	12

PART #	GRIT/ABRASIVE	COLOR	STD. PKG.
2" x 18-15/16"			
05539554503	Coarse A/O	Brown	12
05539554504	Medium A/O	Maroon	12
05539554505	Very Fine A/O	Blue	12
2" x 34"			
05539554497	Coarse A/O	Brown	12
05539554498	Medium A/O	Maroon	12
05539554499	Very Fine A/O	Blue	12
2" x 48"			
05539554500	Coarse A/O	Brown	12
05539554501	Medium A/O	Maroon	12
05539554502	Very Fine A/O	Blue	12
2-3/4" x 15-1/2"			
05539554506	Coarse A/O	Brown	10
05539554507	Medium A/O	Maroon	10
05539554508	Very Fine A/O	Blue	10
3" x 10-11/16"			
05539554509	Coarse A/O	Brown	12
05539554510	Medium A/O	Maroon	12
05539554511	Very Fine A/O	Blue	12
3-1/2" x 15-1/2"			
05539554512	Coarse A/O	Brown	12
05539554513	Medium A/O	Maroon	12
05539554514	Very Fine A/O	Blue	12
4" x 36"			
05539554515	Coarse A/O	Brown	8
05539554516	Medium A/O	Maroon	8
05539554517	Very Fine A/O	Blue	8
6" x 48"			
05539554518	Coarse A/O	Brown	4
05539554519	Medium A/O	Maroon	4
05539554520	Very Fine A/O	Blue	4



INTRODUCTION

Most non-woven products consist of a non-woven web of nylon fibers, impregnated throughout with abrasive grain and bonded with synthetic resins. This design produces a cushioned, three-dimensional material that is extremely pliable and long lasting.

The uniform dispersion of abrasive throughout the web provides a continuous supply of new grain as the old grain and fibers wear away during use.

Non-woven products, with their open mesh construction, are waterproof, washable, resilient, conformable, non-loading, non-conductive, non-metallic, non-rusting and easily pre-formed to conform to special-shaped workpieces.

Since non-woven products are designed for use where stock removal is not required, they begin where other abrasives leave off. The relatively non-aggressive nature of nylon and grit in the non-woven material makes it ideal as a finishing tool. While 60 to 80 grit are considered intermediate sizes in other products, they are considered coarse for non-woven items.

Used wet or dry, non-woven products offer the following advantages:

- Controlled cut without stock removal
- Consistent, uniform finish
- Minimized smearing and discoloration of the workpiece (heat is dissipated through the open mesh of the product)
- Increased production; time savings
- Ability to automate operations
- Reduced operator training
- Less maintenance required
- Greater safety than other methods
- Conformability to irregular surfaces

These advantages make non-woven products excellent alternatives to bristle brushes, set-up wheels, greaseless compounds, and steel wool.

ABRASIVES

- Silicon carbide is sharper, cuts faster, and produces finer scratch patterns on most surfaces.
- Aluminum oxide is more durable, tends to last longer, and produces less discoloration on aluminum.
- Ceramic alumina is the most aggressive on certain applications such as hardened steel parts.
- Non-woven hand pads and rolls are available in a non-abrasive material.

CONVENTIONAL FINISHING METHODS VERSUS NON-WOVEN PRODUCTS

The following chart outlines the advantages achievable when using non-woven products as alternatives to other cleaning, blending, deburring, and finishing methods. Non-woven products are listed in the sequence of normal preference for the application stated. However, because of the numerous variables, only testing can ensure selection of the most cost-effective product.

CONVENTIONAL FINISHING METHOD	KEY APPLICATION	NON-WOVEN PRODUCT AS AN ALTERNATIVE	ADVANTAGES OF FIBRATEx PRODUCT VERSUS ALTERNATE FINISHING METHODS
Bristle Brushes	Cleaning	Flap Wheel	Superior cleaning performance Higher productivity No slurry or compound required More consistent finish Eliminates compound dust and flying bristles
Greaseless Compounds	Finishing	Flap Wheel	Reduced maintenance No compound, instant set-up Elimination of compound dust More uniform finish More consistent work rate
Steel Wool	Cleaning	Rolls Discs Hand Pads	Faster, longer life Less pressure required Non-rusting, cleaner Safer, no splinters

GRITS

Grit refers to the size of the abrasive grain impregnated into the nylon web. Use of large particles results in more aggressive cut and a coarser finish. Small size particles produce fine surface finishes, if all other conditions are equal.

GRIT DESIGNATIONS	COMPARABLE GRIT SIZE
Coarse (C)	50 - 80
Medium (M)	100 - 150
Fine (F)	180 - 220
Very Fine (VF)	240 - 360
Ultra Fine (UF)	600
Micro Fine (MF)	800 - 1200

DENSITIES

The product "density" refers to the number of fibers which have been compressed into the nylon web material. Under identical conditions, harder (closed) density wheels cut faster, last longer, and produce finer finishes than softer (more open) density wheels. Softer density wheels offer greater conformability and have less tendency to load or burn the workpiece.

FIBER SIZING

Several nylon fiber sizes (the denier) are used in the manufacture of non-woven web material because the fiber size is a significant factor in the coating process, as each produces distinct cutting characteristics.

As the intended applications for the specific item determines the fiber size used, the denier is not an optional ingredient and, therefore, is not included in the product offering specifications.

BONDING AGENTS

Waterproof resins are used in the manufacture of non-woven web material to bond the nylon fibers together and to firmly anchor the abrasive grains throughout the web. A variety of resins are utilized in order to obtain the required softness, hardness, toughness, flexibility and other characteristics required of the finished product.

As the intended applications for the specific non-woven item determine the resin type, the resin is not an optional ingredient and, therefore, is not included in the product offering specifications.

GETTING THE MOST OUT OF NON-WOVEN PRODUCTS

Maximum life and best surface conditioning results can be achieved by closely adhering to the following recommendations.

1) DIRECTION

Non-woven conventional flap wheels and unified wheels can be run in either direction. Interleaf flap wheels and convolute wheels must be run only in the direction indicated by the arrow.

2) SPEED

Speed is an important factor in that it affects product finish, rate of cut and wheel life. In general, fast wheel speeds give harder action and a finer finish; whereas, slower speeds give a softer action and a coarser finish for the same wheel density.

The following are recommended operating speeds for the most common applications.

APPLICATION	COMPARABLE GRIT SIZE
Cleaning and upgrading of surface conditions	2200 to 6000 SFPM
Cut-buffing on metal surfaces	6500 to 8000 SFPM
Deburring	5500 to 8000 SFPM
Decorative finishing	500 to 3000 SFPM
Imparting decorative finishes	900 to 3000 SFPM
Oxide Removal	3500 to 6500 SFPM

Testing may show that a slower or faster speed is desirable for specific operations. Never exceed the maximum RPM rating of the wheel.

3) PRESSURE

Light to medium pressure is recommended for most operations. Flap wheels require much lighter pressure to perform properly than other non-woven wheels. Unified wheels can withstand much higher pressures in order to perform deburring jobs. In all cases, avoid excessive pressure which may result in wheel deformation and damage to the work surface.

4) FEED SPEED

Feed speeds directly affect the number of pieces completed over a given period of time. Slow feed speed reduces the number of workpieces completed, while producing a shorter scratch pattern. Slow feed speed allows for longer dwell time and permits more work to be done on each piece. Conversely, a fast feed speed increases the number of workpieces completed, while producing a longer scratch pattern.

5) OSCILLATION

Oscillation may be used to break up scratch lines and produce a more uniform finish. Additionally, an increase in cut may be experienced. A general starting point for oscillation is 3/8" amplitude at 200 cycles per minute.

6) LUBRICANTS

Lubricants, such as water, water soluble oil and straight oil, will decrease the heat generated while running, improve the luster and reduce the surface finish. The higher the viscosity of the lubricant, the lower the surface finish (RMS value) produced.

SURFACE FINISH VARIABLES

Changes in any one of many factors can affect the surface finish on the workpiece. This chart shows the effect on surface finish by changes in single factors of product specifications. Arrows have been used to signify the trend direction. The arrow length does not signify that the effect of each factor is equal.

VARIABLE FACTOR	ROUGH FINISH	SMOOTH SURFACE
	HIGH RMS READING	LOWER RMS READING
1. Grit Size	COARSE ←	→ VERY FINE
2. Wheel Grade	SOFT ←	→ HARD
3. Wheel Speed	SLOW ←	→ FAST
4. Feed Speed	FASTER (LONG SCRATCH) ←	→ SLOWER (SHORT SCRATCH)
5. Oscillation	NO OSCILLATION ←	→ OSCILLATION
6. Lubricants and Compounds	DRY ←	→ WATER SOLUBLE OIL STRAIGHT OIL ← COMPOUNDS →



PREMIER RED REINFORCED PORTABLE SNAGGING WHEELS

Best Tier / Zirconia Alumina Abrasive



Use when grinding with a hand-held machine. Best choice for grinding steel, steel alloys and cast iron.

FEATURES	BENEFITS
<ul style="list-style-type: none"> Premium zirconia alumina abrasive 	<ul style="list-style-type: none"> Fast cut rate 3 times the life of aluminum oxide Greatest productivity
<ul style="list-style-type: none"> High-performance resin bond 	<ul style="list-style-type: none"> Free cutting action Long life
<ul style="list-style-type: none"> High-strength, reinforced construction 	<ul style="list-style-type: none"> Resists breakage

PART #	WHEEL SIZE	GRADING	MAX. RPM	WHEELS/ BOX
FOR IRON/STEEL/METAL				
TYPE 01 – FOR PORTABLE GRINDERS				
05539509169	6 x 1 x 5/8	2ZA14-RBF64	8,000	5
05539509167	8 x 1 x 5/8	2ZA14-RBF64	6,000	5

Minimum quantity = box quantity.



TYPE 01

CARBO GOLD REINFORCED PORTABLE SNAGGING WHEELS

Good Tier / Aluminum Oxide Abrasive



Use when grinding with a hand-held machine. The economical choice for grinding steel, steel alloys and cast iron.

FEATURES	BENEFITS
<ul style="list-style-type: none"> Aluminum oxide abrasive 	<ul style="list-style-type: none"> Fast cut rate
<ul style="list-style-type: none"> Resin bond 	<ul style="list-style-type: none"> Free cutting action Long life
<ul style="list-style-type: none"> High-strength, reinforced construction 	<ul style="list-style-type: none"> Resists breakage

PART #	WHEEL SIZE	GRADING	MAX. RPM	WHEELS/ BOX
FOR IRON/STEEL/METAL				
TYPE 01 – FOR PORTABLE GRINDERS				
05539507347	8 x 1 x 5/8	GA16-P5BF5	4,540	5

Minimum quantity = box quantity.



TYPE 01

REINFORCED PORTABLE SNAGGING WHEELS

Good Tier / Aluminum Oxide Abrasive



Use when grinding with a hand-held machine. Ideal for grinding parting lines, gates and risers.

FEATURES	BENEFITS
<ul style="list-style-type: none"> Aluminum oxide abrasive 	<ul style="list-style-type: none"> Fast cut rate and long life
<ul style="list-style-type: none"> Reinforced 	<ul style="list-style-type: none"> Durable, yet cool cutting

PART #	WHEEL SIZE	GRADING	MAX. RPM	WHEELS/ BOX
FOR IRON/STEEL/METAL				
TYPE 01 – FOR PORTABLE GRINDERS				
05539506618	3 x 1/2 x 3/8	GA24-PBFF	18,080	10

Minimum quantity = box quantity.



TYPE 01

PREMIER RED PORTABLE SNAGGING WHEELS

Best Tier / Zirconia Alumina



Best choice for grinding steel, steel alloys and cast iron. Used for grinding weld seams, cleaning metal before welding, grinding off fins and parting lines, smoothing surfaces on castings, and smoothing surfaces before painting or plating.

FEATURES	BENEFITS
<ul style="list-style-type: none"> Premium zirconia alumina abrasive 	<ul style="list-style-type: none"> Fast cut rate 3 times the life of aluminum oxide abrasive; greatest productivity
<ul style="list-style-type: none"> High-performance resin bond 	<ul style="list-style-type: none"> Free cutting action

FULL STEEL BACK BUSHING

PART #	WHEEL SIZE	GRADING	MAX. RPM	WHEELS/ BOX
FOR IRON/STEEL/METAL				
TYPE 11 – FOR PORTABLE CUP GRINDERS				
05539500694	6 / 4-13/16 x 2 x 5/8-11 Rim 1-1/2, Back 3/4	2ZA16-QB64	6,000	5



TYPE 11

STANDARD BACK BUSHING

PART #	WHEEL SIZE	GRADING	MAX. RPM	WHEELS/ BOX
FOR IRON/STEEL/METAL				
TYPE 11 – FOR PORTABLE CUP GRINDERS				
05539563938	4 / 3 x 2 x 5/8-11 Rim 3/4, Back 3/4	2ZA16-QB64	9,070	10
05539509156	5 / 3-3/4 x 2 x 5/8-11 Rim 1, Back 3/4	2ZA16-QB64	7,260	5
05539508397	6 / 4-3/4 x 2 x 5/8-11 Rim 1-1/2, Back 3/4	2ZA14-RB64	6,000	5
05539509155	6 / 4-3/4 x 2 x 5/8-11 Rim 1-1/2, Back 3/4	2ZA16-PB64	6,000	5
05539507176	6 / 4-3/4 x 2 x 5/8-11 Rim 1-1/2, Back 3/4	2ZA16-QB64	6,000	5

Minimum quantity = box quantity.

CARBO GOLD PORTABLE SNAGGING WHEELS

Good Tier / Aluminum Oxide



Economical choice for grinding steel, steel alloys and all ferrous metals.

FEATURES	BENEFITS
<ul style="list-style-type: none"> Quality aluminum oxide abrasive Resin bond 	<ul style="list-style-type: none"> Fast cut rate Free cutting action

FULL STEEL BACK BUSHING

PART #	WHEEL SIZE	GRADING	MAX. RPM	WHEELS/ BOX
FOR IRON/STEEL/METAL				
TYPE 11 – FOR PORTABLE CUP GRINDERS				
05539507182	6 / 4-13/16 x 2 x 5/8-11 Rim 1-1/2, Back 3/4	A16-PB5	6,000	5



TYPE 11

STANDARD BACK BUSHING

PART #	WHEEL SIZE	GRADING	MAX. RPM	WHEELS/ BOX
FOR IRON/STEEL/METAL				
TYPE 11 – FOR PORTABLE CUP GRINDERS				
05539509166	4 / 3 x 2 x 5/8-11 Rim 3/4, Back 3/4	A16-PB5	9,070	10
05539509162	5 / 3-3/4 x 2 x 5/8-11 Rim 1, Back 3/4	A24-PB5	7,260	5
05539509160	6 / 4-3/4 x 2 x 5/8-11 Rim 1-1/2, Back 3/4	A16-PB5	6,000	5
05539563989	6 / 4-3/4 x 2 x 5/8-11 Rim 1-1/2, Back 3/4	A16-QB5	6,000	5
05539509159	6 / 4-3/4 x 2 x 5/8-11 Rim 1-1/2, Back 3/4	A24-PB5	6,000	5

Minimum quantity = box quantity.

PREMIER RED PORTABLE SNAGGING WHEELS

Best Tier / Zirconia Alumina/Silicon Carbide Blend



Best choice for grinding dirty, scale-covered castings, aluminum and other soft metal castings.

FEATURES	BENEFITS
<ul style="list-style-type: none"> Premium zirconia alumina/silicon carbide abrasive blend 	<ul style="list-style-type: none"> Fast cut rate 3 times the life of aluminum oxide/silicon carbide abrasive blend
<ul style="list-style-type: none"> High performance resin bond 	<ul style="list-style-type: none"> Free cutting action

STANDARD BACK BUSHING

PART #	WHEEL SIZE	GRADING	MAX. RPM	WHEELS/ BOX
FOR SOFT METALS				
TYPE 11 – FOR PORTABLE CUP GRINDERS				
05539507177	6 / 4-3/4 x 2 x 5/8-11 Rim 1-1/2, Back 3/4	2ZC16-QB64	6,000	5
Minimum quantity = box quantity.				



TYPE 11

CARBO GOLD PORTABLE SNAGGING WHEELS

Good Tier / Aluminum Oxide/Silicon Carbide Blend



Economical choice for grinding dirty, scale-covered castings, aluminum and other soft metals.

FEATURES	BENEFITS
<ul style="list-style-type: none"> Quality aluminum oxide/ silicon carbide abrasive blend 	<ul style="list-style-type: none"> Fast cut rate
<ul style="list-style-type: none"> Resin bond 	<ul style="list-style-type: none"> Free cutting action

FULL STEEL BACK BUSHING

PART #	WHEEL SIZE	GRADING	MAX. RPM	WHEELS/ BOX
FOR SOFT METALS				
TYPE 11 – FOR PORTABLE CUP GRINDERS				
05539507183	6 / 4-13/16 x 2 x 5/8-11 Rim 1-1/2, Back 3/4	CGA16-QB5	6,000	5

STANDARD BACK BUSHING

PART #	WHEEL SIZE	GRADING	MAX. RPM	WHEELS/ BOX
FOR SOFT METALS				
TYPE 11 – FOR PORTABLE CUP GRINDERS				
05539507181	6 / 4-3/4 x 2 x 5/8-11 Rim 1-1/2, Back 3/4	CGA16-QB5	6,000	5
Minimum quantity = box quantity.				



TYPE 11



Cone and Plug Shapes



TYPE 16



TYPE 17



TYPE 18



TYPE 18R

PREMIER RED PORTABLE SNAGGING CONES AND PLUGS

Best Tier / Zirconia Alumina



The best choice for grinding steel, steel alloys, and cast iron, for removing burrs and flash, and finishing any type of metal surface in a confined area.

FEATURES	BENEFITS
<ul style="list-style-type: none"> Premium zirconia alumina abrasive 	<ul style="list-style-type: none"> Fastest cut rate 3X the life of aluminum oxide abrasive: greatest productivity
<ul style="list-style-type: none"> High-performance resin bond 	<ul style="list-style-type: none"> Free cutting action

PART #	SIZE	GRADING	MAX. RPM	WHEELS/ BOX
FOR IRON/STEEL/METAL				
TYPE 16 CONES (ROUND END)				
05539520886	2 x 3 x 5/8-11	2ZA20-R	18,145	10
05539520887	2-3/4 x 3-1/2 x 5/8-11	2ZA20-R	13,195	10
TYPE 18 PLUGS (SQUARE END)				
05539520889	2 x 3 x 5/8-11	2ZA20-R	18,145	10
TYPE 18R PLUGS (ROUND END)				
05539520893	1-1/2 x 3 x 5/8-11	2ZA20-R	24,190	10
05539520891	2 x 3 x 5/8-11	2ZA20-R	18,145	10
Minimum quantity = box quantity				



PORTABLE SNAGGING CONES AND PLUGS

Better Tier / Zirconia Alumina/Aluminum Oxide Blend

CARBO™



Excellent for grinding steel, steel alloys and cast iron, for removing burrs and flash and finishing any type of metal surface in a confined area.

FEATURES	BENEFITS
• Performance, zirconia alumina/aluminum oxide abrasive blend	• Fast cut rate
• Resin bond	• Easily grinds scale-covered parts
	• Long life

PART #	SIZE	GRADING	MAX. RPM	WHEELS/ BOX
FOR IRON/STEEL/METAL				
TYPE 16 CONES (ROUND END)				
05539563710	1-1/2 x 3 x 3/8-24	3ZA24-R	24,190	10
05539563711	1-1/2 x 3 x 5/8-11	3ZA20-R	24,190	10

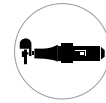

PORTABLE SNAGGING CONES AND PLUGS

Good Tier / Aluminum Oxide

CARBO™



The economical choice for grinding steel or iron castings, removing burrs and flash and finishing metal surfaces in confined areas.

FEATURES	BENEFITS
• Quality, aluminum oxide abrasive	• Fast stock removal
• Resin bond	• Free cutting action

PART #	SIZE	GRADING	MAX. RPM	WHEELS/ BOX
FOR IRON/STEEL/METAL				
TYPE 16 CONES (ROUND END)				
05539509154	1-1/2 x 3 x 5/8-11	A24-R	24,190	10
05539564070	2 x 3 x 3/8-24	A24-R	18,145	10
05539509153	2 x 3 x 5/8-11	A24-R	18,145	10
05539509152	2-3/4 x 3-1/2 x 5/8-11	A24-R	13,195	10
TYPE 17 CONES (SQUARE END)				
05539509150	1-1/2 / 1/2 x 3 x 3/8-24	A24-R	24,190	10
05539509149	2 / 1/2 x 3 x 5/8-11	A24-R	18,145	10
TYPE 18 PLUGS (SQUARE END)				
05539509145	1-1/2 x 2-1/2 x 5/8-11	A24-R	24,190	10
05539509144	1-1/2 x 3 x 3/8-24	A24-R	24,190	10
05539509143	1-1/2 x 3 x 5/8-11	A24-R	24,190	10
05539509142	2 x 3 x 3/8-24	A24-R	18,145	10
05539509141	2 x 3 x 5/8-11	A24-R	18,145	10
05539509139	3 x 4 x 5/8-11	A24-R	12,095	10
TYPE 18R PLUGS (ROUND END)				
05539509138	1-1/2 x 3 x 3/8-24	A24-R	24,190	10
05539509137	1-1/2 x 3 x 5/8-11	A24-R	24,190	10
05539509136	2 x 3 x 5/8-11	A24-R	18,145	10
05539509134	3 x 4 x 5/8-11	A24-R	12,095	10

Minimum quantity = box quantity.

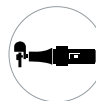

PREMIER RED FOUNDRY FLOORSTAND SNAGGING WHEELS

Better Tier / Zirconia Alumina/Aluminum Oxide Blend



Castings small enough to be carried to the grinder are ground using a floorstand wheel. Ideal for grinding all types of metals, cast iron and cast steel.

FEATURES	BENEFITS
• Performance zirconia alumina/aluminum oxide abrasive blend	• Fast cut rate
• Resin bond	• Easily grinds scale-covered parts
• High-strength, safety web construction	• Extended wheel life
• Convenient 10 wheels/pallet packaging available	• Resists breakage
	• Economical; environmentally-friendly
	• Easy storage and handling

PART #	WHEEL SIZE	GRADING	MAX. RPM	WHEELS/ BOX
FOR IRON/STEEL/METAL				
05539562953	30 x 2 x 12	3AZA14-SBF68	1,595	1
05539562952	30 x 2 x 12	3AZA16-QBF68	1,595	1
SPECIAL PALLET PACK OF 10 WHEELS				
05539563987	30 x 2 x 12	3AZA16-QBF68	1,595	10
Minimum quantity = box quantity.				

FOUNDRY FLOORSTAND SNAGGING WHEELS

Good Tier / Zirconia Alumina/Aluminum Oxide Blend



Castings small enough to be carried to the grinder are ground using a floorstand wheel. The choice for medium- to low-pressure cast iron and metal applications - when initial-price is the main purchasing consideration.

FEATURES	BENEFITS
• Unique zirconia alumina/aluminum oxide abrasive blend	• Competitive performance/ price ratio
• Resin bond	• Ideal for medium to low pressure applications
• High-strength, safety web construction	• Long life
	• Resists breakage

PART #	WHEEL SIZE	GRADING	MAX. RPM	WHEELS/ BOX
FOR IRON/STEEL/METAL				
05539563988	30 x 2 x 12	AZ All Purpose	1,595	1
Minimum quantity = box quantity.				

TOOL POST WHEELS

Good Tier / Aluminum Oxide



Tool post wheels provide the first step in reconditioning heavily damaged high speed tool steel on post grinders and universal attachments on cylindrical grinders.

FEATURES	BENEFITS
• Aluminum oxide abrasive	• Tough and durable, yet cool cutting
• Resin bond	• High-strength and long life

PART #	WHEEL SIZE	GRADING	MAX. RPM	WHEELS/ BOX
FOR STEEL/METAL				
TYPE 01 - FOR TOOL POST GRINDERS				
05539509907	2 x 1/2 x 3/8	A36-P5B6	18,145	10
Minimum quantity = box quantity.				





TOOLROOM GRINDING APPLICATIONS

Toolrooms are found in almost every manufacturing plant throughout the country. They may be called by other names such as machine shops, maintenance shops, or repair shops, however the work done is virtually the same. Toolroom grinding involves the production, maintenance, and repair of cutting tools and machinery parts used in all types of manufacturing operations.

Surface Grinding

The grinding of flat, contoured or angular surfaces on a workpiece which is passed in a horizontal plane against a revolving grinding wheel. Surface grinding applications range from heavy, rapid stock removal operations to precision contouring.

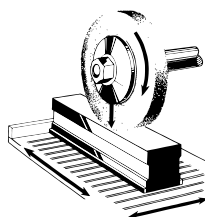

Tool and Cutter Grinding

The grinding or resharpening of milling cutters, reamers, drills, or end mills for the purpose of restoring keen cutting edges or exact cutting angles.

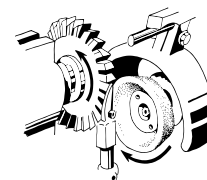

WHEEL SHAPES

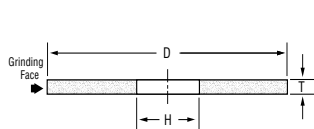

TYPE 01 STRAIGHT

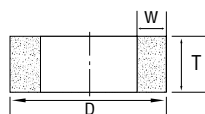

TYPE 02 CYLINDER

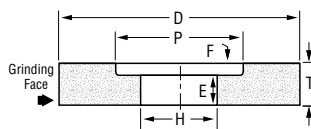

TYPE 05 RECESSED ONE SIDE

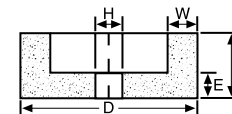

TYPE 06 STRAIGHT CUP

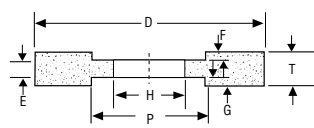

TYPE 07 RECESSED TWO SIDES

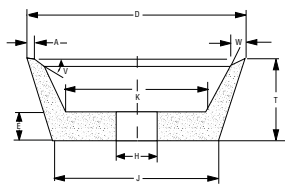

TYPE 11 FLARING CUP

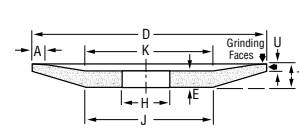

TYPE 12 DISH



TYPE 37

TOOLROOM BASICS SELECTION GUIDE

PRODUCTIVITY	DURABILITY	ABRASIVE	COLOR	GRIT SIZE	GRADE	NARROW CONTACT FORM HOLDING BOND	MEDIUM/WIDE CONTACT AREA POROUS BOND	DRESSING TOOL
Highest	More Durable	Medalist	Blue	46 (Coarse)	E (Soft)	VL	VLP	SG Tool
↑↓	↑↓	Medalist R	Purple	↑↓	↑↓	–	VPP	SG Tool
		32AR	Gray/Purple			V40	V40P	Conventional Tool
		AR	Ruby			V40	VPP	Conventional Tool
		PA	Pink			V40	VPP	Conventional Tool
Standard	More Friable	AA	White	120 (Fine)	P (Hard)	V40	V40P, VPP	Conventional Tool

Abrasive: Select abrasive type based on required performance, stock removal rate, and material to be ground.

Grit Size: Select the grit size depending on finish required, stock removal rate needed, and corner/form holding requirements.

Grade: Select the grade based on contact area*, and heat sensitivity/thickness of material to be ground.

Bond: Select the appropriate bond based on the abrasive selected and the contact area.*

GRIT Selection

TEST GRIT	REQUIREMENTS	FINISH	MINIMUM CORNER RADIUS
46	General purpose	32 Ra and rougher	0.020"
60	Commercial finish	32 Ra and better	0.016"
80, 100	Fine finish	20 Ra and better	0.0105"
120	Very fine finish	10 Ra and better	0.006"

GRADE/BOND SELECTION

GENERAL CONDITIONS AND NEEDS	NORMAL GRADE RANGE	STARTING GRADE	BOND
Narrow* contact area or form holding	K - L	K	VL, V40
General surface grinding	H - K	J	VL, V40
Medium/wide* contact area, cooler grind	F - H	H	VLP, VPP, V40P

***Definitions of Contact Area:**

Narrow: The contact area of the grind is less than 25% of the wheel width, or less than 1/4" wide.

Medium: The contact area of the grind is 25% – 50% of the wheel width, or over 1/4" – 1/2" wide.

Wide: The contact area of the grind is greater than 50% of the wheel width, or over 1/2" wide.

TOOLROOM TROUBLESHOOTING GUIDE

PROBLEM	POSSIBLE CAUSES	CORRECTION
Wheel corner breakdown	Poor wheel dressing Wheel too coarse Wheel too soft Worn machine bearings Wrong wheel structure	Dress wheel finer Use finer grit Use harder grade Check for run-out and correct Use non-porous wheel
Burning of workpiece	Worn dressing tool Poor coolant flow Wheel acting hard Work speed too slow Infeed too fast	Rotate or replace dressing tool Increase/direct coolant flow to contact area Dress wheel coarser, use softer grade wheel or use a porous wheel Increase work speed Reduce stock removed per pass or upgrade to Medalist or 32AR
Poor surface finish	Poor wheel dressing Dirty coolant Wheel too coarse Wheel too hard	Redress more frequently or decrease dress traverse rate Filter coolant or replace with new Use finer grit Use softer grade wheels

NEW! TO MAXIMIZE THE PERFORMANCE OF TOOLROOM WHEELS SEE THE NEW CARBORUNDUM STATIONARY DIAMOND DRESSING TOOLS ON PAGE 156-157.

TOOLROOM WHEEL COMPETITIVE CROSS REFERENCE

CARBORUNDUM	CAMEL	CINCINNATI	RADIAC
32AR	32A	4A, 12A, 29A, 32A	32A, WRA
AA	83A, WA, AZ (Blue)	9A, 10A, 11A, 82A	WA, 9A
AR	–	–	RA
GC	–	5C	GC
Medalist, Medalist R	AS3	3MSB	7BP, 8BP
PA	PA	12A	RAA

TOOLROOM WHEEL STARTING RECOMMENDATIONS BY MATERIAL/APPLICATION

APPLICATION/MATERIAL	PERFORMANCE/PRODUCTIVITY								
	NARROW CONTACT AREA			MEDIUM CONTACT AREA			WIDE CONTACT AREA		
	BEST	BETTER	GOOD	BEST	BETTER	GOOD	BEST	BETTER	GOOD
TOOL RESHARPENING									
HEAVY STOCK REMOVAL (> .004)									
HSS & Tool Steel RC 50-68	Medalist46-KVL	32AR46-KV40	AA46-KV40	Medalist46-JVL	32AR46-JV40	AA46-JV40	Medalist46-GVLP	32AR46-GV40P	AA46-Hv40
MODERATE STOCK REMOVAL (.002 - .004)									
HSS & Tool Steel RC 50-68	Medalist60-KVL	32AR60-KV40	AA60-KV40	Medalist60-JVL	32AR60-JV40	AA60-JV40	Medalist60-GVLP	32A60-HV40P	AA60-Hv40
Carbide	–	–	GC60-IVGC	–	–	GC60-IVGC	–	–	GC60-IVGC
SURFACE GRINDING									
HEAVY STOCK REMOVAL (> .004)									
HSS & Tool Steel RC 50-68 400 Series Stainless	Medalist46-JVL	32AR46-JV40	AA46-JV40	Medalist46-IVL	32AR46-IV40	AA46-IV40	Medalist46-GVLP	32AR46-GV40P	PA46-GVPP
Soft Steels RC 30-45 300 Series Stainless	Medalist46-KVL	32AR46-KV40	AA46-KV40	Medalist46-JVL	32AR46-JV40	AA46-JV40	Medalist46-GVLP	AR46-HVPP	PA46-HVPP
Cast Iron: Ductile & Gray	Medalist46-KVL	32AR46-KV40	AA46-KV40	Medalist46-JVL	32AR46-JV40	AA46-JV40	Medalist46-GVLP	32AR46-HV40P	AA466-HV40
Non-ferrous Alloys	–	–	GC60-IVGC	–	–	GC60-IVGC	–	–	GC60-IVGC
MODERATE STOCK REMOVAL (.002 - .004)									
HSS & Tool Steel RC 50-68 400 Series Stainless	Medalist60-JVL	32AR60-JV40	AA60-JV40	Medalist60-IVL	32AR60-IV40	AA60-IV40	Medalist60-GVLP	32AR46-GV40P	AA60-HV40
Soft Steels RC 30-45 300 Series Stainless	Medalist60-KVL	32AR60-KV40	AA60-KV40	Medalist60-JVL	32AR60-JV40	AA60-JV40	Medalist60-GVLP	32AR46-HV40P	AA60-HV40
Cast Iron: Ductile & Gray	Medalist60-KVL	32AR60-KV40	AA60-KV40	Medalist60-JVL	32AR60-JV40	AA60-JV40	Medalist60-GVLP	32AR46-HV40P	AA60-IV40
Non-ferrous Alloys	–	–	GC60-IVGC	–	–	GC60-IVGC	–	–	GC60-IVGC
LIGHT STOCK REMOVAL AND FINISHING (</.001)									
HSS & Tool Steel RC 50-68 400 Series Stainless	–	32AR80-JV40	AA80-JV40	–	32AR80-IV40	AA80-IV40	–	32AR60-HV40	AA80-HV40
Soft Steels RC 30-45 300 Series Stainless	–	32AR80-KV40	AA80-KV40	–	32AR80-JV40	AA80-JV40	–	32AR80-IV40	AA80-IV40
Cast Iron: Ductile & Gray	–	32AR80-KV40	AA80-KV40	–	32AR80-JV40	AA80-JV40	–	32AR80-IV40	AA80-IV40
Non-ferrous Alloys	–	–	GC80-IVGC	–	–	GC80-IVGC	–	–	GC80-IVGC

MEDALIST TOOLROOM WHEELS FOR STEEL APPLICATIONS

Best Tier / Ceramic Alumina / Aluminum Oxide Blend



The best choice for grinding all high speed tool steels. Medalist has the versatility to grind easy- to difficult-to-grind steels. Use VL bond for general purpose applications or medium contact areas. Use VLP and VPP bonds on wide contact areas where heat is an issue. See Page 145 for additional porous specifications.

FEATURES	BENEFITS
<ul style="list-style-type: none"> High-performance ceramic alumina / aluminum oxide abrasive blend – blue color 	<ul style="list-style-type: none"> Fast stock removal on moderate to very heavy stock removal applications Cool cutting
<ul style="list-style-type: none"> Self-sharpening abrasive 	<ul style="list-style-type: none"> Less burn on part Dressing frequency reduced
<ul style="list-style-type: none"> High-performance vitrified bond 	<ul style="list-style-type: none"> Enhanced wheel life Superior form and corner holding
<ul style="list-style-type: none"> VLP bond: induced porosity 	<ul style="list-style-type: none"> Load resistant
<ul style="list-style-type: none"> Best performance 	<ul style="list-style-type: none"> Highest productivity, lowest total grinding cost

PART #	WHEEL SIZE	GRADING	MAX. RPM	WHEELS/ BOX
TYPE 01 – FOR SURFACE, CYLINDRICAL AND TOOL & CUTTER GRINDERS				
05539562350	6" x 1/4" x 1-1/4"	80-KVL	4,140	10
05539562351 B	7" x 1/4" x 1-1/4"	46-JVL	3,600	10
05539527241	7" x 1/4" x 1-1/4"	60-IVL	3,600	10
05539527242 B	7" x 1/4" x 1-1/4"	60-JVL	3,600	10
05539527243	7" x 1/4" x 1-1/4"	60-KVL	3,600	10
05539527244	7" x 1/4" x 1-1/4"	80-JVL	3,600	10
05539527245	7" x 1/4" x 1-1/4"	80-KVL	3,600	10
05539527247	7" x 1/4" x 1-1/4"	100-KVL	3,600	10
05539527248	7" x 1/2" x 1-1/4"	46-GVLP	3,600	5
05539527250	7" x 1/2" x 1-1/4"	46-IVL	3,600	5
05539527249 B	7" x 1/2" x 1-1/4"	46-IVLP	3,600	5
05539527251	7" x 1/2" x 1-1/4"	46-JVL	3,600	5
05539527252	7" x 1/2" x 1-1/4"	46-KVL	3,600	5
05539527255 B	7" x 1/2" x 1-1/4"	60-IVL	3,600	5
05539527256	7" x 1/2" x 1-1/4"	60-JVL	3,600	5
05539527257 B	7" x 1/2" x 1-1/4"	60-KVL	3,600	5
05539527260	7" x 1/2" x 1-1/4"	80-JVL	3,600	5
05539527261 B	7" x 1/2" x 1-1/4"	80-KVL	3,600	5
05539527262 B	7" x 3/4" x 1-1/4"	46-KVL	3,600	5
05539527264	7" x 1" x 1-1/4"	46-JVL	3,600	5
05539527268 B	8" x 1/2" x 1-1/4"	46-IVL	3,105	5
05539527269	8" x 1/2" x 1-1/4"	46-JVL	3,600	5
05539527270	8" x 1/2" x 1-1/4"	46-KVL	3,600	5
05539527271	8" x 1/2" x 1-1/4"	60-IVL	3,600	5
05539527272	8" x 1/2" x 1-1/4"	60-JVL	3,600	5
05539527273	8" x 1/2" x 1-1/4"	60-KVL	3,600	5
05539562363	8" x 1/2" x 1-1/4"	80-JVL	3,600	5
05539527274	8" x 3/4" x 1-1/4"	46-IVL	3,105	5
05539527275	8" x 3/4" x 1-1/4"	46-JVL	3,600	5
05539527276	8" x 3/4" x 1-1/4"	46-KVL	3,600	5
05539527277	8" x 3/4" x 1-1/4"	60-JVL	3,600	5
05539562365	8" x 1" x 1-1/4"	46-IVL	3,105	5
05539527279	10" x 1" x 3"	46-IVL	2,485	2
05539527280	10" x 1" x 3"	46-JVL	2,485	2
05539527282	10" x 1" x 3"	60-JVL	2,485	2
05539562382	12" x 3/4" x 1-1/4"	46-OVL	2,070	1
05539527283	12" x 1" x 3"	46-IVL	2,070	2
05539527284	12" x 1" x 3"	46-JVL	2,070	2
05539564511	12" x 1" x 3"	60-GVPP	2,070	2
05539527287	12" x 1" x 5"	46-JVL	2,070	2
05539527290	12" x 1" x 5"	60-JVL	2,070	2
05539562337 B	12" x 1-1/2" x 5"	60-GVLP	2,070	2
05539527291	14" x 1" x 5"	46-GVLP	1,800	2
05539527292	14" x 1" x 5"	46-JVL	1,800	2
05539527293	14" x 1" x 5"	60-JVL	1,800	2
05539527294	14" x 1-1/2" x 5"	46-GVLP	1,800	1
05539527295 B	14" x 1-1/2" x 5"	46-IVL	1,800	1

PART #	WHEEL SIZE	GRADING	MAX. RPM	WHEELS/ BOX
TYPE 01 – FOR SURFACE, CYLINDRICAL AND TOOL & CUTTER GRINDERS				
05539527296	14" x 1-1/2" x 5"	46-JVL	1,800	1
05539562346 B	14" x 1-1/2" x 5"	60-IVL	1,800	1
05539527298	14" x 1-1/2" x 5"	60-JVL	1,800	1
05539562347	14" x 1-1/2" x 5"	80-KVL	1,800	1
05539562348	14" x 2" x 5"	46-JVL	1,800	1
05539562349	14" x 2" x 5"	60-JVL	1,800	1
TYPE 05 – FOR SURFACE GRINDERS				
05539527300	7" x 1" x 1-1/4" Recess 1/S 2-3/4" x 1/2"	46-JVL	3,600	5
05539527301	7" x 1" x 1-1/4" Recess 1/S 2-3/4" x 1/2"	60-JVL	3,600	5
05539562370	7" x 1" x 1-1/4" Recess 1/S 3" x 1/2"	60-KVL	3,600	5
05539562366	12" x 1-1/2" x 5" Recess 1/S 7-1/2" x 1/2"	46-GVLP	2,070	2
05539562367	14" x 1-1/2" x 5" Recess 1/S 8" x 1/2"	46-JVL	1,800	1
TYPE 07 – FOR SURFACE GRINDERS				
05539564513	12" x 2" x 5" Recess 2/S 7-1/2" x 1/2"	60-GVPP	2,070	1
TYPE 11 – FOR TOOL & CUTTER GRINDERS				
05539527302	4" / 3" x 1-1/2" x 1-1/4" Rim 1/4", Back 1/2"	46-JVL	5,730	5
05539527303	4" / 3" x 1-1/2" x 1-1/4" Rim 1/4", Back 1/2"	60-JVL	5,730	5
05539527305	5" / 3-3/4" x 1-3/4" x 1-1/4" Rim 1/4", Back 1/2"	46-JVL	4,585	5
05539527306	5" / 3-3/4" x 1-3/4" x 1-1/4" Rim 1/4", Back 1/2"	60-KVL	4,585	5
TYPE 12 – FOR TOOL & CUTTER GRINDERS				
05539527308	6" x 1/2" x 1-1/4" U = 3/8, E = 5/16 J = 3, K = 3	46-JVL	4,140	5
05539562380	8" x 1-9/16" x 1-1/4" U = 7/16, E = 25/32, J = 3, K = 3	46-JVL	3,105	4
TYPE 37 – FOR SURFACE GRINDERS				
05539562383	10" x 3-1/2" x 8" Rim 1", Eight 1/4"-20 Bolts on 9" Bolt Circle	54-IVL	2,105	1

Minimum quantity = box quantity. | B = Best Seller



techtip

OPERATING TIPS FOR MAXIMIZING GRINDING PERFORMANCE WITH

MEDALIST WHEELS

Change one parameter at a time:

- Increase infeed 50%
- Increase traverse rate 25%
- Reduce dressing infeed 25%

CARBO GOLD TOOLROOM WHEELS FOR STEEL APPLICATIONS

Better Tier / 32AR Aluminum Oxide



Ideal for moderate to heavy infeed rates, rapid stock removal and precision contouring – for all types of tool steels. Use V40 bond for general purpose applications or medium contact areas. Use V40P bond on wide contact areas where heat is an issue. See Page 145 for additional porous specifications.

FEATURES	BENEFITS
<ul style="list-style-type: none"> High-performance aluminum oxide abrasive - gray/purple color Strong, sharp monocrystalline grain blend 	<ul style="list-style-type: none"> Exceptionally cool, fast cutting on medium to heavy stock removal operations Excellent resistance to point wear Good penetration on tough alloy steels
<ul style="list-style-type: none"> Tough, yet friable grain 	<ul style="list-style-type: none"> Holds form well Requires less dressing
<ul style="list-style-type: none"> Strong vitrified bond V40P bond: induced porosity 	<ul style="list-style-type: none"> Long wheel life Load resistance

PART #	WHEEL SIZE	GRADING	MAX. RPM	WHEELS/BOX
TYPE 01 – FOR SURFACE, CYLINDRICAL AND TOOL & CUTTER GRINDERS				
05539527692	6" x 1/2" x 1-1/4"	32AR60-JV40	4,140	10
05539562244	6" x 1/2" x 1-1/4"	32AR60-KV40	4,140	10
05539527686	7" x 1/4" x 1-1/4"	32AR46-HV40	3,600	10
05539527688	7" x 1/4" x 1-1/4"	32AR46-JV40	3,600	10
05539527689	7" x 1/4" x 1-1/4"	32AR60-IV40	3,600	10
05539527311 B	7" x 1/4" x 1-1/4"	32AR60-JV40	3,600	10
05539527312	7" x 1/4" x 1-1/4"	32AR60-KV40	3,600	10
05539527314	7" x 1/4" x 1-1/4"	32AR80-JV40	3,600	10
05539527315 B	7" x 1/4" x 1-1/4"	32AR80-KV40	3,600	10
05539562246 B	7" x 1/4" x 1-1/4"	32AR100-JV40	3,600	10
05539562249	7" x 1/4" x 1-1/4"	32AR120-KV40	3,600	10
05539527317	7" x 1/2" x 1-1/4"	32AR46-GV40P	3,600	5
05539527319	7" x 1/2" x 1-1/4"	32AR46-HV40	3,600	5
05539527318 B	7" x 1/2" x 1-1/4"	32AR46-HV40P	3,600	5
05539527321	7" x 1/2" x 1-1/4"	32AR46-IV40	3,600	5
05539527320	7" x 1/2" x 1-1/4"	32AR46-IV40P	3,600	5
05539527322	7" x 1/2" x 1-1/4"	32AR46-JV40	3,600	5
05539527323	7" x 1/2" x 1-1/4"	32AR46-KV40	3,600	5
05539527326	7" x 1/2" x 1-1/4"	32AR60-HV40	3,600	5
05539527327	7" x 1/2" x 1-1/4"	32AR60-IV40	3,600	5
05539527328 B	7" x 1/2" x 1-1/4"	32AR60-JV40	3,600	5
05539527329	7" x 1/2" x 1-1/4"	32AR60-KV40	3,600	5
05539527331	7" x 1/2" x 1-1/4"	32AR80-KV40	3,600	5
05539527334	7" x 3/4" x 1-1/4"	32AR46-IV40	3,600	5
05539527335	7" x 3/4" x 1-1/4"	32AR46-KV40	3,600	5
05539527337 B	7" x 3/4" x 1-1/4"	32AR60-KV40	3,600	5
66253054775	8" x 1/4" x 1-1/4"	32AR46-KV40	3,600	5
05539562264	8" x 1/4" x 1-1/4"	32AR60-JV40	3,600	5
05539527338	8" x 1/4" x 1-1/4"	32AR60-KV40	3,600	5
05539527339	8" x 1/4" x 1-1/4"	32AR80-KV40	3,600	5
05539527340 B	8" x 1/2" x 1-1/4"	32AR46-GV40	3,105	5
05539527342	8" x 1/2" x 1-1/4"	32AR46-HV40	3,105	5
05539527341†	8" x 1/2" x 1-1/4"	32AR46-HV40P	3,600	5
05539527343 B	8" x 1/2" x 1-1/4"	32AR46-IV40	3,105	5
05539527344	8" x 1/2" x 1-1/4"	32AR46-JV40	3,600	5
05539527345	8" x 1/2" x 1-1/4"	32AR46-KV40	3,600	5
05539527347	8" x 1/2" x 1-1/4"	32AR60-HV40	3,600	5
05539527348	8" x 1/2" x 1-1/4"	32AR60-IV40	3,600	5

PART #	WHEEL SIZE	GRADING	MAX. RPM	WHEELS/BOX
TYPE 01 – FOR SURFACE, CYLINDRICAL AND TOOL & CUTTER GRINDERS				
05539527349 B	8" x 1/2" x 1-1/4"	32AR60-JV40	3,600	5
05539527353	8" x 3/4" x 1-1/4"	32AR46-IV40	3,105	5
05539527354	8" x 3/4" x 1-1/4"	32AR46-JV40	3,600	5
05539527355	8" x 3/4" x 1-1/4"	32AR60-IV40	3,600	5
05539527356	8" x 3/4" x 1-1/4"	32AR60-JV40	3,600	5
05539562272	8" x 1" x 1-1/4"	32AR60-IV40	3,600	5
05539562201	10" x 3/4" x 3"	32AR46-IV40	2,485	2
05539527696	10" x 3/4" x 3"	32AR60-JV40	2,485	2
05539527697	10" x 1" x 3"	32AR46 GV40P	2,485	2
05539527359	10" x 1" x 3"	32AR46-IV40	2,485	2
05539527360	10" x 1" x 3"	32AR60-IV40	2,485	2
05539562204	10" x 1" x 3"	32AR60-KV40	2,485	2
05539527361	12" x 1" x 3"	32AR46-HV40	2,070	2
05539562216 B	12" x 1" x 3"	32AR46-IV40	2,070	2
05539527362	12" x 1" x 3"	32AR46-JV40	2,070	2
05539527364	12" x 1" x 3"	32AR60-JV40	2,070	2
05539527365	12" x 1" x 5"	32AR46-IV40	2,070	2
05539562221	12" x 1-1/4" x 3"	32AR46-IV40	2,070	2
05539527368 B	12" x 1-1/2" x 5"	32AR46-HV40	2,070	2
05539527369	12" x 1-1/2" x 5"	32AR46-IV40	2,070	2
05539562224	12" x 1-1/2" x 5"	32AR46-JV40	2,070	2
05539562226	12" x 1-1/2" x 5"	32AR60-HV40	2,070	2
05539562227	12" x 2" x 1-1/4"	32AR46-KV40	2,070	2
05539562316	12" x 2" x 5"	32AR46-IV40	2,070	2
05539562230	14" x 1" x 5"	32AR46-HV40	1,800	2
05539527370	14" x 1" x 5"	32AR46-JV40	1,800	2
05539527371	14" x 1" x 5"	32AR60-JV40	1,800	2
05539527372 B	14" x 1-1/2" x 5"	32AR46-HV40	1,800	1
05539527673	14" x 1-1/2" x 5"	32AR46-IV40	1,800	1
05539527700	14" x 1-1/2" x 5"	32AR46-JV40	1,800	1
05539562240	14" x 2" x 5"	32AR46-IV40	1,800	1
05539562242	14" x 2" x 5"	32AR60-KV40	1,800	1

Minimum quantity = box quantity. | B = Best Seller
Continued on next page



techtip

It is the user's responsibility to refer to and comply with ANSI B7.1

8" TYPE 01 AND TYPE 05 VITRIFIED TOOLROOM WHEELS' MAXIMUM OPERATING SPEEDS:

- 46 grit, J grade and harder = 3,600 RPMs
- 54 grit, I grade and harder = 3,600 RPMs
- 60 grit and finer, H grade and harder = 3,600 RPMs
- † Exceptions to the rule: speed-tested to 3,600 RPMs
- all other specifications = 3,105 RPMs



PART #	WHEEL SIZE	GRADING	MAX. RPM	WHEELS/BOX
TYPE 02 – FOR SURFACE AND TOOL & CUTTER GRINDERS				
05539562315	9" x 2" x 5" Rim 2-1/32", Six 9/32 Holes on 4" Bolt Circle	32AR70-JV40P	2,546	2
TYPE 05 – FOR SURFACE GRINDERS				
05539527703	7" x 1" x 1-1/4" Recess 1/S 2-3/4" x 1/2"	32AR46-HV40	3,600	5
05539527675	7" x 1" x 1-1/4" Recess 1/S 2-3/4" x 1/2"	32AR46-IV40	3,600	5
05539527704	7" x 1" x 1-1/4" Recess 1/S 2-3/4" x 1/2"	32AR60-IV40	3,600	5
05539562285	7" x 1" x 1-1/4" Recess 1/S 3" x 1/2"	32AR46-KV40	3,600	5
05539562286	7" x 1-1/4" x 1-1/4" Recess 1/S 2-3/4" x 5/8"	32AR60-IV40	3,600	5
05539527677	8" x 1" x 1-1/4" Recess 1/S 3-1/4" x 1/2"	32AR46-IV40	3,600	5
05539527678	8" x 1" x 1-1/4" Recess 1/S 3-1/4" x 1/2"	32AR46-JV40	3,600	5
05539562277	12" x 1-1/2" x 5" Recess 1/S 7-1/2" x 1/2"	32AR46-IV40	2,070	2
05539562279	14" x 1-1/2" x 5" Recess 1/S 8" x 1/2"	32AR46-IV40	1,800	1
05539562281	14" x 1-1/2" x 5" Recess 1/S 8" x 1/2"	32AR60-IV40	1,800	1
05539562283	14" x 2" x 5" Recess 1/S 8" x 1"	32AR60-KV40	1,800	1
TYPE 06 – FOR TOOL & CUTTER GRINDERS				
05539562288	5 x 1-1/2" x 1-1/4" " Rim 3/8", Back 3/8"	32AR46-KV40	4,585	5
05539527705	5 x 1-1/2" x 1-1/4" " Rim 3/8", Back 3/8"	32AR60-KV40	4,585	5
TYPE 07 – FOR SURFACE GRINDERS				
05539562292	12" x 2" x 5" Recess 2/S 7-1/2" x 1/2"	32AR46-HV40	2,070	1
05539562294	12" x 2" x 5" Recess 2/S 7-1/2" x 1/2"	32AR46-KV40	2,070	1

PART #	WHEEL SIZE	GRADING	MAX. RPM	WHEELS/BOX
TYPE 11 – FOR TOOL & CUTTER GRINDERS				
05539527679	4" / 3" x 1-1/2" x 1-1/4" Rim 1/4", Back 1/2"	32AR46-KV40	5,730	5
05539527680	4" / 3" x 1-1/2" x 1-1/4" Rim 1/4", Back 1/2"	32AR60-JV40	5,730	5
05539527681	4" / 3" x 1-1/2" x 1-1/4" Rim 1/4", Back 1/2"	32AR60-KV40	5,730	5
05539527682	5" / 3-3/4" x 1-3/4" x 1-1/4" Rim 1/4", Back 1/2"	32AR46-JV40	4,585	5
05539527684	5" / 3-3/4" x 1-3/4" x 1-1/4" Rim 1/4", Back 1/2"	32AR46-KV40	4,585	5
05539527685	5" / 3-3/4" x 1-3/4" x 1-1/4" Rim 1/4", Back 1/2"	32AR60-JV40	4,585	5
05539527683	5" / 3-3/4" x 1-3/4" x 1-1/4" Rim 1/4", Back 1/2"	32AR60-KV40	4,585	5
05539562301	6" / 4-1/2" x 2" x 1-1/4" Rim 3/8", Back 1/2"	32AR46-IV40	3,820	5
TYPE 12 – FOR TOOL & CUTTER GRINDERS				
05539527707	6" x 1/2" x 1-1/4" U = 3/8, E = 5/16 J = 3, K = 3	32AR60-JV40	4,140	5
05539562303	10" x 1" x 1-1/4" U = 2, E = 11/16, J = 6-1/4, K = 3-5/8	32AR54-JV40	2,485	2

Minimum quantity = box quantity.



See Carbo Cool wheel listings for porous specifications on pages 145.

NEW! TO MAXIMIZE THE PERFORMANCE OF TOOLROOM WHEELS SEE THE NEW CARBORUNDUM STATIONARY DIAMOND DRESSING TOOLS ON PAGE 156-157.



AA abrasive is ideal for grinding heat-sensitive steels, as well as easy- and medium-to-grind high-speed steels and cast, alloy steels. Use V40 bond for general purpose applications or medium contact areas. Use V40P and VPP bonds on wide contact areas where heat is an issue.

FEATURES	BENEFITS
• Aluminum oxide abrasive – white color	• Fast stock removal for light to medium stock removal operations
• Excellent friability	• Cool cutting action
• Durable, vitrified bond	• Long wheel life
• V40P bond: induced porosity	• Load resistant

PART #	WHEEL SIZE	GRADING	MAX. RPM	WHEELS/ BOX
TYPE 01 – FOR SURFACE, CYLINDRICAL AND TOOL & CUTTER GRINDERS				
05539562175	7" x 1/8" x 1-1/4"	AA100-KV40	3,600	10
66253051696	7" x 1/4" x 1-1/4"	AA46-IV40	3,600	10
05539509875	7" x 1/4" x 1-1/4"	AA60-JV40	3,600	10
05539509874	7" x 1/4" x 1-1/4"	AA60-KV40	3,600	10
66253051698	7" x 1/4" x 1-1/4"	AA80-JV40	3,600	10
05539527714	7" x 1/4" x 1-1/4"	AA100-KV40	3,600	10
05539509866	7" x 1/4" x 1-1/4"	AA150-KV40	3,600	10
05539569199	7" x 1/4" x 1-1/4"	PA60-JV40	3,600	10
05539509865	7" x 1/2" x 1-1/4"	AA46-HV40	3,600	5
05539509864	7" x 1/2" x 1-1/4"	AA46-IV40	3,600	5
05539509863	7" x 1/2" x 1-1/4"	AA46-JV40	3,600	5
05539509862	7" x 1/2" x 1-1/4"	AA46-KV40	3,600	5
66253051967	7" x 1/2" x 1-1/4"	AA60-HV40	3,600	5
05539564489	7" x 1/2" x 1-1/4"	AA60-HVPP	3,600	5
05539509860	7" x 1/2" x 1-1/4"	AA60-IV40	3,600	5
05539509859	7" x 1/2" x 1-1/4"	AA60-JV40	3,600	5
05539509858	7" x 1/2" x 1-1/4"	AA60-KV40	3,600	5
66253051969	7" x 1/2" x 1-1/4"	AA80-HV40	3,600	5
05539509857	7" x 1/2" x 1-1/4"	AA80-IV40	3,600	5
05539509854	7" x 1/2" x 1-1/4"	AA80-KV40	3,600	5
05539509852	7" x 1/2" x 1-1/4"	AA100-IV40	3,600	5
05539562180	7" x 1/2" x 1-1/4"	AA120-KV40	3,600	5
05539509848	7" x 3/4" x 1-1/4"	AA60-IV40	3,600	5
05539509844 B	8" x 1/4" x 1-1/4"	AA80-JV40	3,600	5
05539509841	8" x 1/2" x 1-1/4"	AA46-HV40	3,105	5
05539509840	8" x 1/2" x 1-1/4"	AA46-IV40	3,105	5
05539509839	8" x 1/2" x 1-1/4"	AA46-JV40	3,600	5
05539509836	8" x 1/2" x 1-1/4"	AA60-IV40	3,600	5
05539562190	8" x 1/2" x 1-1/4"	AA60-JV40	3,600	5
66253052850	8" x 1/2" x 1-1/4"	AA60-KV40	3,600	5
05539527716	8" x 1/2" x 1-1/4"	AA80-JV40	3,600	5
05539509827	8" x 3/4" x 1-1/4"	AA46-JV40	3,600	5
05539509814	10" x 1" x 3"	AA46-JV40	2,485	2
05539509810	12" x 1" x 3"	AA46-JV40	2,070	2
05539501900	12" x 1" x 5"	AA46-IV40	2,070	2
05539509807	12" x 1" x 5"	AA60-JV40	2,070	2
05539509806	14" x 1" x 5"	AA46-JV40	1,800	2
05539562172	14" x 1-1/2" x 5"	AA46-IV40	1,800	1
05539509804 B	14" x 1-1/2" x 5"	AA46-JV40	1,800	1
05539509803	14" x 1-1/2" x 5"	AA60-JV40	1,800	1
TYPE 02 – FOR SURFACE AND TOOL & CUTTER GRINDERS				
05539503517	9" x 2" x 5" Rim 2-1/32", Six 9/32 Holes on 4" Bolt Circle	AA70-JV40P	2,546	2

PART #	WHEEL SIZE	GRADING	MAX. RPM	WHEELS/ BOX
TYPE 05 – FOR SURFACE GRINDERS				
66253054746	7" x 3/4" x 1-1/4" Recess 1/8" x 1/4"	AA46-IV40	3,600	5
66253054748	7" x 3/4" x 1-1/4" Recess 1/8" x 1/4"	AA46-JV40	3,600	5
05539509798	7" x 1" x 1-1/4" Recess 1/8" x 1/2"	AA46-IV40	3,600	5
66253054767	7" x 1" x 1-1/4" Recess 1/8" x 1/2"	AA46-JV40	3,600	5
05539509796	7" x 1" x 1-1/4" Recess 1/8" x 1/2"	AA60-IV40	3,600	5
66253054769	7" x 1" x 1-1/4" Recess 1/8" x 1/2"	AA60-JV40	3,600	5
TYPE 06 – FOR TOOL & CUTTER GRINDERS				
05539509793	4" x 2" x .787 (20mm) Rim 3/8", Back 3/8"	AA80-JV40	5,730	5
05539509792	6" x 1-1/2" x 1-1/4" Rim 1-1/2", Back 1/2"	AA60-JV40	3,820	5
TYPE 11 – FOR TOOL & CUTTER GRINDERS				
05539509790	4" / 3" x 1-1/2" x 1-1/4" Rim 1/4", Back 1/2"	AA46-KV40	5,730	5
05539569412	5" / 3-3/4" x 1-3/4" x 1-1/4" Rim 1/4", Back 1/2"	AA46-JV40	4,585	5
05539509783	5" / 3-3/4" x 1-3/4" x 1-1/4" Rim 1/4", Back 1/2"	AA60-JV40	4,585	5
05539509782	5" / 3-3/4" x 1-3/4" x 1-1/4" Rim 1/4", Back 1/2"	AA60-KV40	4,585	5
05539509781	6" / 4-1/2" x 2" x 1-1/4" Rim 3/8", Back 1/2"	AA46-KV40	3,820	5
TYPE 12 – FOR TOOL & CUTTER GRINDERS				
05539509777	6" x 1/2" x 1-1/4" U = 3/8, E = 5/16 J = 3, K = 3	AA60-JV40	4,140	5

Minimum quantity = box quantity. | B = Best Seller



See Carbo Cool wheel listings for porous specifications on pages 146.

CARBO PA TOOLROOM WHEELS FOR STEEL APPLICATIONS

Good Tier / Aluminum Oxide

CARBO™



Excels in light to medium stock removal applications at light to moderate feed rates on tool steels (hardened, forged and stainless) and cast iron. Use V40 bond for general purpose applications or medium contact areas. Use VPP bond on wide contact areas where heat is an issue.

FEATURES	BENEFITS
<ul style="list-style-type: none"> Friable, aluminum oxide abrasive – pink color 	<ul style="list-style-type: none"> Designed to grind a broad variety of steels at light to moderate feed rates
<ul style="list-style-type: none"> Durable vitrified bond 	<ul style="list-style-type: none"> Maximum grain retention Less dressing; longer wheel life

PART #	WHEEL SIZE	GRADING	MAX. RPM	WHEELS/ BOX
TYPE 01 – FOR SURFACE, CYLINDRICAL AND TOOL & CUTTER GRINDERS				
05539569199	7" x 1/4" x 1-1/4"	PA60-JV40	3,600	10
05539564571	12" x 1" x 3"	PA60-GVPP	2,070	2
Minimum quantity = box quantity.				



See Carbo Cool wheel listings for porous specifications on page 146.

CARBO GOLD 32AR SKATE SHARPENING WHEELS

Better Tier / Aluminum Oxide

CARBO
GOLD™



Formulated for sharpening all types of skate blades.

FEATURES	BENEFITS
<ul style="list-style-type: none"> Premium aluminum oxide abrasive – gray/purple color 	<ul style="list-style-type: none"> Fast, cool cutting action No burn
<ul style="list-style-type: none"> Strong vitrified bond 	<ul style="list-style-type: none"> Consistent form holding Long life
<ul style="list-style-type: none"> Plastic bushing 	<ul style="list-style-type: none"> Provides a tighter fit – reducing vibrations and arbor-wear on the skate grinder

PART #	WHEEL SIZE	GRADING	MAX. RPM	WHEELS/ BOX
TYPE 01 – FOR SKATE SHARPENING MACHINES				
05539528044	8 x 5/16 x 1-1/4	32AR80-KV40	3,600	5
TYPE 01 CROSS GRIND – FOR SKATE SHARPENING MACHINES				
05539509972	6 x 1 x 1	60 - Medium	4,140	5
Minimum quantity = box quantity.				



CARBO COOL MEDALIST R TOOLROOM WHEELS FOR STEEL APPLICATIONS

Best Tier / Ceramic Alumina



High porosity for heavy stock removal, heat-sensitive applications.

FEATURES	BENEFITS
<ul style="list-style-type: none"> Ceramic Medalist R abrasive with VPP porous bond – purple color Controlled porosity bond 	<ul style="list-style-type: none"> Maximum productivity; lowest total grinding costs Increased chip clearance, maximum coolant flow, reduced loading Cool cutting – wet or dry – in heat-sensitive applications
<ul style="list-style-type: none"> Durable bond post 	<ul style="list-style-type: none"> Maximum grain retention Less dressing; longer wheel life
<ul style="list-style-type: none"> Maximum depth of cut 	<ul style="list-style-type: none"> Consistent grinding action at high metal removal rates

PART #	WHEEL SIZE	GRADING	MAX. RPM	WHEELS/ BOX
HIGH POROSITY – FOR HEAVY STOCK REMOVAL				
TYPE 01 – FOR SURFACE, CYLINDRICAL AND TOOL & CUTTER GRINDERS				
05539564503	8 x 1/2 x 1-1/4	46-HVPP	3,600	5
Minimum quantity = box quantity.				

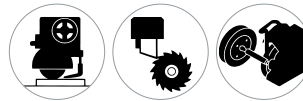

CARBO COOL AR TOOLROOM WHEELS FOR STEEL APPLICATIONS

Better Tier / Aluminum Oxide



Engineered for medium to heavy stock removal, heat-sensitive applications.

FEATURES	BENEFITS
<ul style="list-style-type: none"> Durable aluminum oxide abrasive with VPP porous bond – ruby color Controlled porosity bond 	<ul style="list-style-type: none"> Extremely cool cutting Good form holding Increased chip clearance, maximum coolant flow, reduced loading Cool cutting – wet or dry – in heat-sensitive applications
<ul style="list-style-type: none"> Durable bond post 	<ul style="list-style-type: none"> Maximum grain retention Less dressing; longer wheel life

PART #	WHEEL SIZE	GRADING	MAX. RPM	WHEELS/ BOX
HIGH POROSITY – FOR MEDIUM/HEAVY STOCK REMOVAL				
TYPE 01 – FOR SURFACE, CYLINDRICAL AND TOOL & CUTTER GRINDERS				
05539564480	7 x 1/2 x 1-1/4	AR46-GVPP	3,600	5
05539564484	7 x 1/2 x 1-1/4	AR46-HVPP	3,600	5
05539564486	7 x 1/2 x 1-1/4	AR60-HVPP	3,600	5
TYPE 01 – FOR SURFACE, CYLINDRICAL AND TOOL & CUTTER GRINDERS				
05539564530	8 x 1/2 x 1-1/4	AR46-HVPP	3,600	5
Minimum quantity = box quantity.				

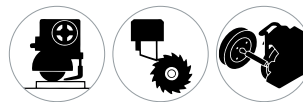

NEW! TO MAXIMIZE THE PERFORMANCE OF TOOLROOM WHEELS SEE THE NEW CARBORUNDUM STATIONARY DIAMOND DRESSING TOOLS ON PAGE 156-157.

CARBO COOL PA TOOLROOM WHEELS FOR STEEL APPLICATIONS

Good Tier / Aluminum Oxide



Excels in light to medium stock removal, heat-sensitive applications.

FEATURES	BENEFITS
<ul style="list-style-type: none"> Friable, aluminum oxide abrasive with VPP porous bond – pink color Controlled porosity bond 	<ul style="list-style-type: none"> Designed to grind a broad variety of steels at light to moderate feed rates Increased chip clearance and maximum coolant flow Reduced loading Cool cutting – wet or dry – in heat-sensitive applications
<ul style="list-style-type: none"> Durable bond post 	<ul style="list-style-type: none"> Maximum grain retention Less dressing; longer wheel life



PART #	WHEEL SIZE	GRADING	MAX. RPM	WHEELS/ BOX
HIGH POROSITY – FOR LIGHT/MEDIUM STOCK REMOVAL				
TYPE 01 – FOR SURFACE, CYLINDRICAL AND TOOL & CUTTER GRINDERS				
05539564477	7 x 1/2 x 1-1/4	PA46-GVPP	3,600	5
05539564490	7 x 1/2 x 1-1/4	PA46-HVPP	3,600	5
05539564492	7 x 1/2 x 1-1/4	PA60-HVPP	3,600	5

Minimum quantity = box quantity.



CARBO COOL AA TOOLROOM WHEELS FOR STEEL APPLICATIONS

Good Tier / Aluminum Oxide



Excellent for light stock removal, heat-sensitive applications.

FEATURES	BENEFITS
<ul style="list-style-type: none"> Most friable aluminum oxide abrasive with VPP porous bond – white color Versatile Controlled porosity bond 	<ul style="list-style-type: none"> Exceptionally cool cutting in light pressure grinding applications, or where burn is a concern Ideal for use across a broad variety of tool steels Increased chip clearance, maximum coolant flow, reduced loading Cool cutting – wet or dry – in heat-sensitive applications
<ul style="list-style-type: none"> Durable bond post 	<ul style="list-style-type: none"> Maximum grain retention Less dressing; longer wheel life



PART #	WHEEL SIZE	GRADING	MAX. RPM	WHEELS/ BOX
HIGH POROSITY – FOR LIGHT STOCK REMOVAL				
TYPE 01 – FOR SURFACE, CYLINDRICAL AND TOOL & CUTTER GRINDERS				
05539564479	7 x 1/2 x 1-1/4	AA46-GVPP	3,600	5
05539564487	7 x 1/2 x 1-1/4	AA46-HVPP	3,600	5
05539564599	8 x 1/2 x 1-1/4	AA46-HVPP	3,600	5

Minimum quantity = box quantity.

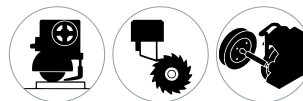



GC abrasive is used for grinding hard, cemented carbide tooling and non-ferrous materials.

FEATURES	BENEFITS
<ul style="list-style-type: none"> • High performance, sharp, silicon carbide abrasive – green 	<ul style="list-style-type: none"> • Fast stock removal • Cool, free cut
<ul style="list-style-type: none"> • Performance vitrified bond 	<ul style="list-style-type: none"> • Long life

PART #	WHEEL SIZE	GRADING	MAX. RPM	WHEELS/ BOX
FOR CARBIDE				
TYPE 01 – FOR SURFACE AND TOOL & CUTTER GRINDERS				
05539509585 B	6 x 1/2 x 1-1/4	GC80-IVGC	4,140	5
05539509582	6 x 1/2 x 1-1/4	GC120-IVGC	4,140	5
05539509581	6 x 3/4 x 1-1/4	GC60-IVGC	4,140	5
05539509580	6 x 3/4 x 1-1/4	GC80-IVGC	4,140	5
05539509578	6 x 3/4 x 1-1/4	GC120-IVGC	4,140	5
05539509576	7 x 1/2 x 1-1/4	GC60-IVGC	3,600	5
05539509575	7 x 1/2 x 1-1/4	GC80-IVGC	3,600	5
05539509573	7 x 1/2 x 1-1/4	GC120-IVGC	3,600	5
05539509572	8 x 1/2 x 1-1/4	GC60-IVGC	3,600	5
05539562395 B	8 x 1/2 x 1-1/4	GC100-IVGC	3,600	5
05539509570	8 x 3/4 x 1-1/4	GC60-IVGC	3,600	5
05539562397	8 x 1 x 1-1/4	GC60-JVGC	3,600	5
05539562398	8 x 1 x 1-1/4	GC80-IVGC	3,600	5

PART #	WHEEL SIZE	GRADING	MAX. RPM	WHEELS/ BOX
FOR CARBIDE				
TYPE 01 – FOR SURFACE AND TOOL & CUTTER GRINDERS (CONTINUED)				
05539509566	6 x 1 x 4 Rim 1, Fits Both: Four 9/32 Holes on 3-1/4" Bolt Circle Four 7/16 Holes on 3-1/4" Bolt Circle	GC60-IVGC	3,600	2
05539509564	6 x 1 x 4 Rim 1, Fits Both: Four 9/32 Holes on 3-1/4" Bolt Circle Four 7/16 Holes on 3-1/4" Bolt Circle	GC120-IVGC		2

Minimum quantity = box quantity. | B = Best Seller



NEW! TO MAXIMIZE THE PERFORMANCE OF TOOLROOM WHEELS SEE THE NEW CARBORUNDUM STATIONARY DIAMOND DRESSING TOOLS ON PAGE 156-157.

BENCH AND PEDESTAL WHEELS

Good Tier / Aluminum Oxide

CARBO™



Ideal for removing burrs on steel parts, as well as sharpening high-speed steel cutting tools.
Note: arbor hole reducing bushings included. See next page.

FEATURES	BENEFITS
<ul style="list-style-type: none"> Aluminum oxide abrasive – brown color 	<ul style="list-style-type: none"> Fast cut rate
<ul style="list-style-type: none"> Vitrified bond 	<ul style="list-style-type: none"> Free cutting action; long life

PART #	WHEEL SIZE	GRADING	MAX. RPM	WHEELS/ BOX
FOR STEEL/METAL				
TYPE 01 – FOR BENCH AND PEDESTAL GRINDERS				
05539509978	6 x 1/2 x 1	60-M	4,140	5
05539509976	6 x 3/4 x 1	36-M	4,140	5
05539509975	6 x 3/4 x 1	60-M	4,140	5
05539509974	6 x 3/4 x 1	100-K	4,140	5
05539509973	6 x 1 x 1	36-M	4,140	5
05539509972	6 x 1 x 1	60-M	4,140	5
05539509971	6 x 1 x 1	100-K	4,140	5
05539509966	7 x 1 x 1	36-M	3,600	5
66253059536	7 x 1 x 1	46-M	3,600	5
05539509965	7 x 1 x 1	60-M	3,600	5
05539509964	7 x 1 x 1	100-K	3,600	5
05539509961	8 x 3/4 x 1	60-M	3,600	5
05539509960	8 x 1 x 1	24-P	3,600	5
05539509959	8 x 1 x 1	36-M	3,600	5
05539509956	8 x 1 x 1	60-M	3,600	5
66253060236	8 x 1 x 1	80-M	3,600	5
05539509955	10 x 1 x 1-1/4	24-P	2,485	2
05539509953	10 x 1 x 1-1/4	36-M	3,250	2

PART #	WHEEL SIZE	GRADING	MAX. RPM	WHEELS/ BOX
FOR STEEL/METAL				
TYPE 01 – FOR BENCH AND PEDESTAL GRINDERS CONTINUED				
05539509952	10 x 1 x 1-1/4	60-M	3,250	2
05539509950	10 x 1-1/4 x 1-1/4	36-M	3,250	2
05539509948	10 x 1-1/2 x 1-1/4	24-P	2,485	2
05539509947	10 x 1-1/2 x 1-1/4	36-M	3,250	2
05539509941	12 x 1-1/2 x 1-1/2	36-M	2,705	1
05539509939	12 x 2 x 1-1/2	24-P	2,070	1
05539509938	12 x 2 x 1-1/2	36-M	2,705	1
05539509937	12 x 2 x 1-1/2	60-M	2,705	1
05539509935	14 x 2 x 1-1/2	24-P	1,800	1
05539509934	14 x 2 x 1-1/2	36-M	1,800	1

Minimum quantity = box quantity.

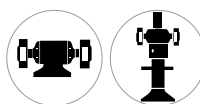

CARBO WHITE BENCH AND PEDESTAL WHEELS

Standard Tier / Aluminum Oxide

CARBO™
WHITE™



Good choice for general purpose light metal removal and resharpener of steel and metal tools.
Note: arbor hole reducing bushings included. See next page.

FEATURES	BENEFITS
<ul style="list-style-type: none"> Versatile aluminum oxide abrasive – brown color 	<ul style="list-style-type: none"> Ideal for small job shops and numerous general purpose applications The choice when initial price is a primary purchasing criterion
<ul style="list-style-type: none"> Vitrified bond 	<ul style="list-style-type: none"> Free cutting action; long life

PART #	WHEEL SIZE	GRADING	MAX. RPM	WHEELS/ BOX
FOR STEEL/METAL				
TYPE 01 – FOR BENCH AND PEDESTAL GRINDERS				
66253383004	6 x 3/4 x 1	Coarse	4,140	2
66253383005	6 x 3/4 x 1	Medium	4,140	2
66253383006	6 x 3/4 x 1	Fine	4,140	2
66253383007	6 x 1 x 1	Coarse	4,140	2
66253383008	6 x 1 x 1	Medium	4,140	2
66253383009	6 x 1 x 1	Fine	4,140	2
66253383010	8 x 1 x 1	Coarse	3,600	2
66253383011	8 x 1 x 1	Medium	3,600	2
66253383012	8 x 1 x 1	Fine	3,600	2

Minimum quantity = box quantity.

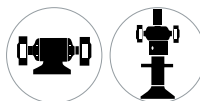

BENCH AND PEDESTAL WHEELS

Good Tier / Silicon Carbide

CARBO™



Ideal for sharpening carbide-tipped cutting tools. Note: arbor hole reducing bushings included. See below.

FEATURES	BENEFITS
<ul style="list-style-type: none"> Sharp, silicon carbide abrasive – dark green color 	<ul style="list-style-type: none"> Fast cut rate
<ul style="list-style-type: none"> Vitrified bond 	<ul style="list-style-type: none"> Free cutting action; long life

PART #	WHEEL SIZE	GRADING	MAX. RPM	WHEELS/ BOX
FOR CARBIDE/NON-FERROUS METALS				
TYPE 01 – FOR BENCH AND PEDESTAL GRINDERS				
05539509929	6 x 3/4 x 1	60-I	4,140	1
05539509928	6 x 3/4 x 1	80-I	4,140	1
05539509927	6 x 3/4 x 1	120-I	4,140	1
05539509926	6 x 1 x 1	60-I	4,140	1
05539509925	6 x 1 x 1	80-I	4,140	1
05539509924	6 x 1 x 1	120-I	4,140	1
66253060288	7 x 1 x 1	60-I	3,600	5
05539509922	7 x 1 x 1	80-I	3,600	5
05539509920	7 x 1 x 1	120-I	3,600	5
05539509916	8 x 1 x 1	60-I	3,600	5

PART #	WHEEL SIZE	GRADING	MAX. RPM	WHEELS/ BOX
FOR CARBIDE/NON-FERROUS METALS				
TYPE 01 – FOR BENCH AND PEDESTAL GRINDERS CONTINUED				
05539509915	8 x 1 x 1	80-I	3,600	5
05539509914	8 x 1 x 1	120-I	3,600	5
05539509913	10 x 1 x 1-1/4	60-I	3,250	2
05539509912	10 x 1 x 1-1/4	80-I	3,250	2
05539509911	10 x 1 x 1-1/4	120-I	3,250	2

Minimum quantity = box quantity.

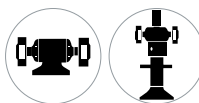

CARBO WHITE BENCH AND PEDESTAL WHEELS

Standard Tier / Silicon Carbide

CARBO™
WHITE



Good choice for general purpose bench and pedestal applications on non-ferrous materials and carbide tooling. Note: arbor hole reducing bushings included. See below.

FEATURES	BENEFITS
<ul style="list-style-type: none"> Sharp, silicon carbide abrasive – green color 	<ul style="list-style-type: none"> Ideal for small job shops and numerous general purpose applications The choice when initial price is a primary purchasing criterion
<ul style="list-style-type: none"> Vitrified bond 	<ul style="list-style-type: none"> Free cutting action; long life

PART #	WHEEL SIZE	GRADING	MAX. RPM	WHEELS/ BOX
FOR CARBIDE/NON-FERROUS METALS				
TYPE 01 – FOR BENCH AND PEDESTAL GRINDERS				
66253383015	6 x 3/4 x 1	Medium	4,140	2
66253383016	6 x 3/4 x 1	Fine	4,140	2
66253383017	6 x 1 x 1	Medium	4,140	2
66253383018	6 x 1 x 1	Fine	4,140	2
66253383019	8 x 1 x 1	Medium	3,600	2
66253383021	8 x 1 x 1	Fine	3,600	2

Minimum quantity = box quantity



REDUCING BUSHINGS FOR BENCH AND PEDESTAL WHEELS

Accessory



Reducing bushings can be safely used to reduce the center hole in a grinding wheel. They are designed to fit freely on the spindle and maintain proper clearance. It is important that the bushing diameter does not come in contact with the flange bearing area and does not exceed the width of the wheel.

Reducing bushings are included with Bench and Pedestal Wheels as follows:

WHEEL DIAMETER	BUSHING	WHEEL DIAMETER	BUSHING
6", 7"	7/8, 3/4, 5/8, 1/2	12"	1-1/4, 1
8"	7/8, 3/4, 5/8	14"	1-1/4, 1
10"	1, 7/8, 3/4		

MEDALIST SURFACE GRINDING SEGMENTS

Best Tier / Ceramic Alumina



Ideal for high stock removal on flat surfaces. Best for grinding hard materials.

FEATURES	BENEFITS
• High-performance, ceramic alumina abrasive - blue color	• Fastest stock removal; maximum productivity
• Self-sharpening abrasive	• Cool cutting
• High-performance bond	• Less burn on part
• Induced porosity	• Enhanced segment life
	• Cool, free cut with excellent chip/coolant flow

PART NO.	SEGMENT SIZE	GRADING	TYPE	SEGMENTS/BOX
05539507043	5 x 1-1/2 x 6	30-EVLP	NO	8
05539507044	5 x 1-1/2 x 6	30-GVLP	NO	8
05539507047	11-1/4 x 2-1/4 x 6	30-EVLP	CD	5
05539562907	11-1/4 x 2-1/4 x 6	30-FVLP	CD	5
05539507048	11-1/4 x 2-1/4 x 6	30-GVLP	CD	5



PREMIER RED SURFACE GRINDING SEGMENTS

Better Tier / Aluminum Oxide

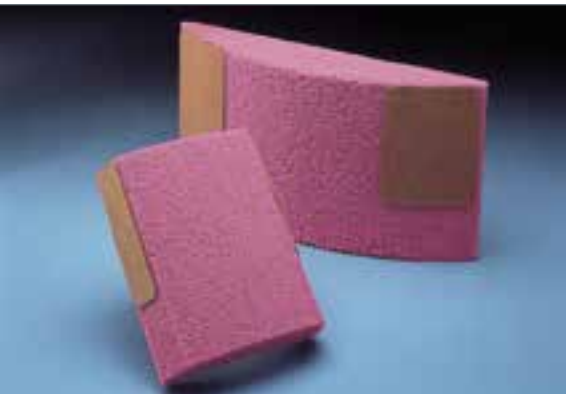

Engineered for high stock removal on flat surfaces. Very versatile; work well on mild steels.

FEATURES	BENEFITS
• Performance, aluminum oxide abrasive - pink color	• Fast, cool cutting action
• Premium vitrified bond with induced porosity	• Long life with cool, free cut

PART NO.	SEGMENT SIZE	GRADING	TYPE	SEGMENTS/BOX
05539562911	5 x 1-1/2 x 6	RA30-GV40P	NO	8
05539562912	11-1/4 x 2-1/4 x 6	RA24-EV40P	CD	5
05539562914	11-1/4 x 2-1/4 x 6	RA30-EV40P	CD	5
05539562915	11-1/4 x 2-1/4 x 6	RA30-GV40P	CD	5



CARBO GOLD SURFACE GRINDING SEGMENTS

Good Tier / Aluminum Oxide

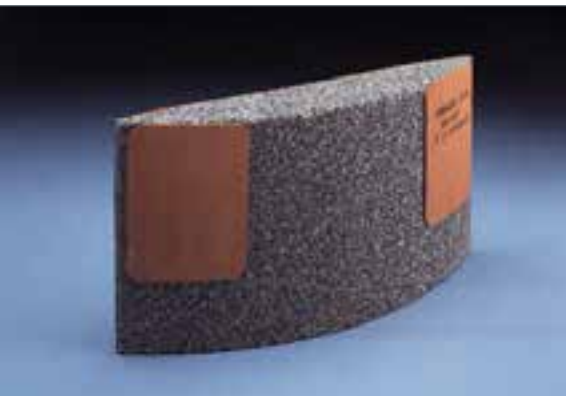

For high stock removal on flat surfaces. Excellent value for general purpose use.

FEATURES	BENEFITS
• Excellent value, aluminum oxide abrasive blend - gray/pink color	• Fast, cool cutting action
• Advanced vitrified bond with induced porosity	• Long life with cool, free cut

PART NO.	SEGMENT SIZE	GRADING	TYPE	SEGMENTS/BOX
05539563010	11-1/4 x 2-1/4 x 6	Gold 30-E	CD	5
05539562922	11-1/4 x 2-1/4 x 6	Gold 30-F	CD	5
05539562924	11-1/4 x 3 x 8	Gold 30-F	CD*	4

* Bonus Grind



SIZE = WIDTH X THICKNESS X HEIGHT

SEGMENT NO.	SEGMENTS PER SET FOR NORTON-MATTISON CHUCKS (NO):
NO14	6
NO18	8
NO20	9
NO22	10

SEGMENT NO.	SEGMENTS PER SET FOR CORTLAND CHUCKS (CD):
CD18L	4
CD22L	5
CD36	8

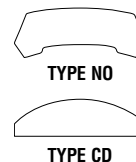

NORZON MOUNTED POINTS – RESIN BOND

Best Tier / Zirconia Alumina



Premium quality mounted points for metal fabricating and foundry applications. 24 grit: snagging castings, smoothing contours, removing fins and parting lines.

FEATURES

- Self-sharpening zirconia alumina abrasive
- Durable resin bond

BENEFITS

- Aggressive, free cut
- 4 times faster stock removal than competitive aluminum oxide products
- Long lasting

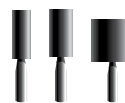
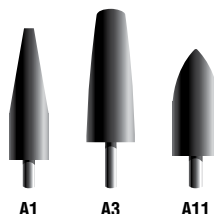
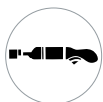

A1

A3

A11

W SHAPES

PART #	SHAPE	SIZE D X L	SPINDLE	GRADING	MAX. RPM	MIN/STD PKG.
"A" SHAPES						
61463616457	A1	3/4 x 2-1/2	1/4	NZ24-UBXR1	19,800	5/25
61463616459	A3	1 x 2-3/4	1/4	NZ24-UBXR1	16,100	5/25
61463616463	A11	7/8 x 2	1/4	NZ24-UBXR1	19,860	5/25

PART #	SHAPE	SIZE D X L	SPINDLE	GRADING	MAX. RPM	MIN/STD PKG.
"W" SHAPES						
61463616465	W189	1/2 x 2	1/4	NZ24-UBXR1	24,000	5/25
61463616467	W197	5/8 x 2	1/4	NZ24-UBXR1	21,000	5/25
61463616471	W208	3/4 x 2	1/4	NZ24-UBXR1	18,750	5/25
61463617520	W220	1 x 1	1/4	NZ24-UBXR1	25,500	5/25
61463616473	W221	1 x 1-1/2	1/4	NZ24-UBXR1	19,120	5/25
61463616475	W222	1 x 2	1/4	NZ24-UBXR1	15,900	5/25

Shank length is 1-1/2". Maximum operating speed based on 1/2" overhang.

CHARGER MOUNTED POINTS – RESIN BOND

Better Tier / Zirconia Alumina



Premium quality mounted points for metal fabricating and foundry applications. 30 grit: deburring, removing weld beads, smoothing and blending welded areas.

FEATURES

- Self-sharpening 30 grit zirconia alumina abrasive
- Specially formulated organic bond

BENEFITS

- 35% faster cut rate than standard aluminum oxide
- An aggressive, free cut
- More parts cleaned in less time to substantially increase productivity
- 5X greater life than ordinary aluminum oxide
- Reduces vibration and wheel chatter

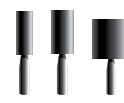
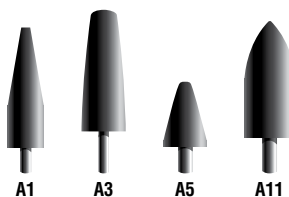

A1

A3

A5

A11

W SHAPES

PART #	SHAPE	SIZE D X L	SPINDLE	GRADING	MAX. RPM	MIN/STD PKG.
"A" SHAPES						
61463616458	A1	3/4 x 2-1/2	1/4	Charger	19,800	5/25
61463616460	A3	1 x 2-3/4	1/4	Charger	16,100	5/25
61463616462	A5	3/4 x 1-1/8	1/4	Charger	45,000	5/25
61463616464	A11	7/8 x 2	1/4	Charger	19,860	5/25

PART #	SHAPE	SIZE D X L	SPINDLE	GRADING	MAX. RPM	MIN/STD PKG.
"W" SHAPES						
61463616466	W189	1/2 x 2	1/4	Charger	24,000	5/25
61463616470	W207	3/4 x 1-1/2	1/4	Charger	24,000	5/25
61463616472	W208	3/4 x 2	1/4	Charger	18,750	5/25
61463617521	W220	1 x 1	1/4	Charger	25,500	5/25
61463616474	W221	1 x 1-1/2	1/4	Charger	19,120	5/25
61463616476	W222	1 x 2	1/4	Charger	15,900	5/25

Shank length is 1-1/2". Maximum operating speed based on 1/2" overhang.

techtip

- Use "A" shapes for medium- to heavy-duty blending
- Use "W" shapes for offhand and precision grinding of medium to heavy stock



It is the user's responsibility to refer to and comply with ANSI B7.1

FIBER-REINFORCED MOUNTED POINTS – RESIN BOND

Good Tier / Aluminum Oxide



Engineered for blending, polishing, and finishing dies, cavities, etc.

FEATURES	BENEFITS
• Cotton fiber reinforced aluminum oxide	• Ideal for blending and finishing parts without changing geometry
• 80 grit	• For most materials
• 120 grit	• For polishing and stainless steel applications

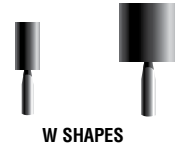

PART #	SHAPE	SIZE D X L	SPINDLE	GRADING	MAX. RPM	MIN/STD PKG.
FOR POLISHING						
61463622664	A11	7/8 x 2	1/4	A80-HBF3	19,860	25/25
61463620242	B52	3/8 x 3/4	1/8	A120-HBF3	45,370	25/25
61463622657	B121	1/2" Ball	1/8	A80-HBF3	45,370	25/25
61463622655	W163	1/4 x 1/2	1/8	A80-HBF3	60,000	25/25
61463622656	W163	1/4 x 1/2	1/8	A120-HBF3	60,000	25/25

PART #	SHAPE	SIZE D X L	SPINDLE	GRADING	MAX. RPM	MIN/STD PKG.
FOR POLISHING (CONTINUED)						
61463622654	W176	3/8 x 1/2	1/8	A80-HBF3	45,370	25/25
61463622649	W185	1/2 x 1/2	1/8	A80-HBF3	34,500	25/25
61463622651	W187	1/2 x 1	1/8	A80-HBF3	20,620	25/25
61463622646	W220	1 x 1	1/4	A80-HBF3	25,500	25/25

Shank length is 1-1/2". Maximum operating speed based on 1/2" overhang.

CENTER LAP MOUNTED POINTS – VITRIFIED BOND

Better Tier / Aluminum Oxide Abrasive



For use on Ex-Cello Center Lap and similar machines to produce accurate centers – precisely angled, truly conical, and free from ridges – for cylindrical grinding.

FEATURES	BENEFITS
• Specially formulated wheel treatment (#5 wood resin)	• Adds lubricity to the point, minimizing risk of metallurgical damage
• Large diameter spindle	• Minimum deflection, rigid support
• Precise dimensional tolerances	• Ensure accurate location of centers

PART #	SIZE D X L	SPINDLE	GRADING	MAX. RPM	MIN/STD PKG.
FOR CENTER LAPPING					
61463621421	1/2 x 2**	1/2	A80-VVM	65,000	5/25
61463622926	1 x 2**	1/2	A80-VVM	15,900	5/25

Shank length is 1-1/2". Maximum operating speed based on 1/2" overhang.
** Pointed 60°.

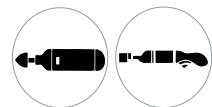

techtip

DESCRIPTION OF OVERHANG

- Overhang is the distance between the grinder chuck and the abrasive on the spindle. The larger the overhang, the lower the maximum safe operating speed.
- Maximum operating speed is based on 1/2" overhang.
- The standard shank length is 1-1/2".

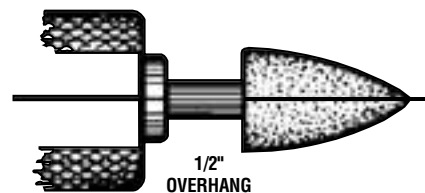

It is the user's responsibility to refer to and comply with ANSI B7.1

GEMINI MOUNTED POINTS – VITRIFIED BOND

Good Tier / Aluminum Oxide



“A” Shape Applications. Ideal for general maintenance applications in metal fabrication plants.

“B” Shape Applications: Ideal for light deburring of machined parts and for finishing/polishing molds and dies.

“W” Shape Applications: Ideal for precision grinding machine parts, molds and dies, involving medium to heavy stock removal.

FEATURES	BENEFITS
• Quality 38A aluminum oxide abrasive – brown color	• Cool cutting, less burn
• Vitrified bond	• Long life • Consistent form holding
• Diverse shapes and sizes	• Ideal when initial price is the main purchasing consideration • Great choice for small job shops

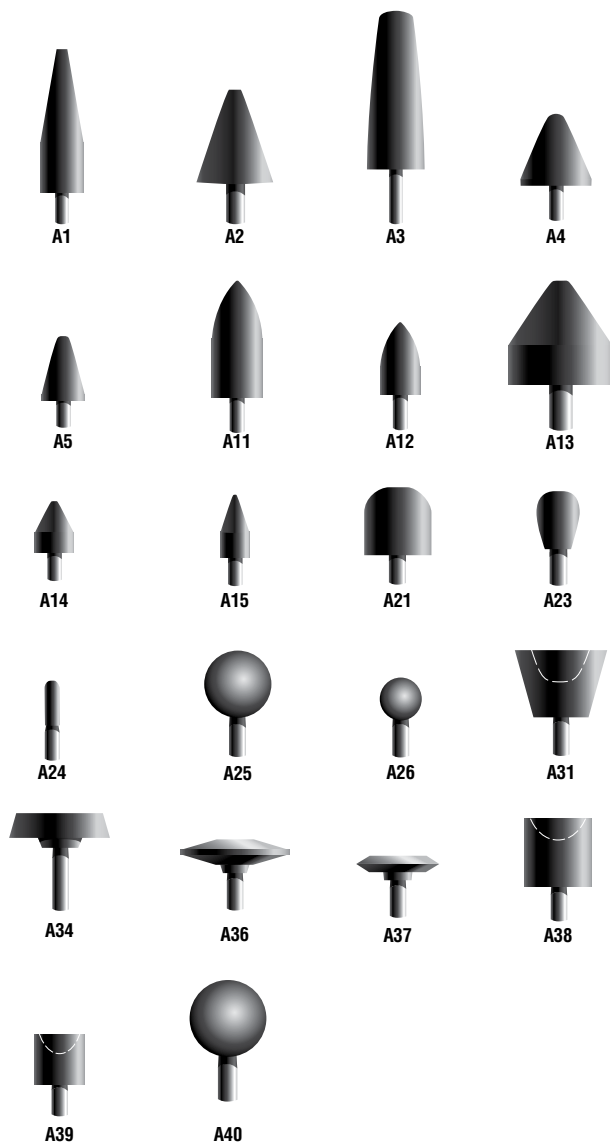

PART #	SHAPE	SIZE D X L	SPINDLE	GRADING	MAX. RPM	MIN/STD PKG.
“A” SHAPES – FOR GENERAL MAINTENANCE						
61463624374	A1	3/4 x 2-1/2	1/4	38A36-T	19,800	5/25
61463624375	A1	3/4 x 2-1/2	1/4	38A60-P	19,800	5/25
07660724376	A2	1 x 1/4	1/4	38A60-P	38,200	5/25
61463624377	A3	1 x 2-3/4	1/4	38A36-T	16,100	5/25
61463624378	A3	1 x 2-3/4	1/4	38A60-P	16,100	5/25
61463624380	A4	1-1/4 x 1-1/4	1/4	38A60-P	30,560	5/25
61463624381	A5	3/4 x 1-1/8	1/4	38A36-T	45,000	5/25
61463624382	A5	3/4 x 1-1/8	1/4	38A60-P	45,000	5/25
61463624384	A11	7/8 x 2	1/4	38A36-T	19,860	5/25
61463624385	A11	7/8 x 2	1/4	38A60-P	19,860	5/25
61463624388	A12	11/16 x 1-1/4	1/4	38A60-P	48,000	5/25
61463624389	A13	1-1/8 x 1-1/8	1/4	38A60-P	33,950	5/25
61463624390	A14	11/16 x 7/8	1/4	38A60-P	55,560	5/25
61463624391	A15	1/4 x 1-1/16	1/4	38A60-P	72,750	5/25
61463624392	A21	1 x 1	1/4	38A60-P	34,500	5/25
61463624394	A23	3/4 x 1	1/4	38A60-P	39,370	5/25
61463624395	A24	1/4 x 3/4	1/4	38A60-P	76,500	5/25
61463624396	A25	1" Ball	1/4	38A60-P	35,620	5/25
61463624397	A26	5/8" Ball	1/4	38A60-P	61,120	5/25
61463624399	A31	1-3/8 x 1	1/4	38A60-P	27,780	5/25
61463624402	A34	1-1/2 x 3/8	1/4	38A60-P	25,470	5/25
61463624404	A36	1-5/8 x 3/8	1/4	38A60-P	23,520	5/25
61463624405	A37	1-1/4 x 1/4	1/4	38A60-P	30,560	5/25
61463624406	A38	1 x 1	1/4	38A60-P	34,500	5/25
61463624407	A39	3/4 x 3/4	1/4	38A60-P	47,250	5/25
61463624408	A40	3/4" Ball	1/4	38A60-P	47,250	5/25

Standard shank size is 1/4" x 1-1/2".

Maximum operating speed based on 1/2" overhang.

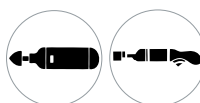

GEMINI MOUNTED POINTS – VITRIFIED BOND [CONTINUED]

Good Tier / Aluminum Oxide

PART #	SHAPE	SIZE D X L	SPINDLE	GRADING	MAX. RPM	MIN/STD PKG.
"B" SHAPES – FOR LIGHT DEBURRING AND FINISHING						
61463624410	B41	5/8 x 5/8	1/8	38A60-P	33,570	5/25
61463624412	B42	1/2 x 3/4	1/8	38A60-P	33,570	5/25
61463624413	B43	1/4 x 5/16	1/8	38A60-P	81,370	5/25
61463624414	B44	7/32 x 3/8	1/8	38A60-P	68,400	5/25
61463624415	B45	3/16 x 5/16	1/8	38A60-P	104,250	5/25
61463624416	B46	1/8 x 5/16	1/8	38A60-P	105,000	5/25
61463624418	B51	7/16 x 3/4	1/8	38A60-P	45,370	5/25
61463624420	B52	3/8 x 3/4	1/8	38A60-P	45,370	5/25
61463624419	B52	3/8 x 3/4	1/4	38A60-P	81,000	5/25
61463624422	B52	3/8 x 3/4	1/8	38A90-Q	45,370	5/25
61463624423	B53	5/16 x 5/8	1/8	38A60-P	60,000	5/25
61463624424	B54	1/4 x 1/2	1/8	38A60-P	60,000	5/25
61463624425	B55	1/8 x 1/4	1/8	38A60-P	105,000	5/25
61463624437	B81	3/4 x 3/16	1/8	38A60-P	50,930	5/25
61463624443	B91	1/2 x 5/8	1/8	38A60-P	34,500	5/25
61463624448	B96	1/8 x 1/4	1/8	38A60-P	105,000	5/25
61463624449	B96	1/8 x 1/4	1/8	38A90-Q	105,000	5/25
61463624451	B97	1/8 x 3/8	1/8	38A60-P	105,000	5/25
61463624452	B98	3/32 x 1/4	1/8	38A60-P	105,000	5/25
61463624466	B121	1/2" Ball	1/8	38A60-P	45,370	5/25
61463624470	B122	3/8" Ball	1/8	38A60-P	61,650	5/25
61463624471	B122	3/8" Ball	1/8	38A90-Q	61,650	5/25
61463624472	B123	3/16" Ball	1/8	38A60-P	104,250	5/25
61463624474	B124	1/8" Ball	1/8	38A90-Q	105,000	5/25
61463624475	B131	1/2 x 1/2	1/8	38A60-P	34,500	5/25
61463624479	B132	3/8 x 1/2	1/8	38A60-P	45,370	5/25
61463624481	B133	3/8 x 3/8	1/8	38A60-P	54,000	5/25
61463624482	B134	5/16 x 3/8	1/8	38A60-P	61,650	5/25
61463624484	B135	1/4 x 1/2	1/8	38A60-P	60,000	5/25
61463624485	B136	1/4 x 5/16	1/8	38A60-P	77,250	5/25

Shank length is 1-1/2". Maximum operating speed based on 1/2" overhang.

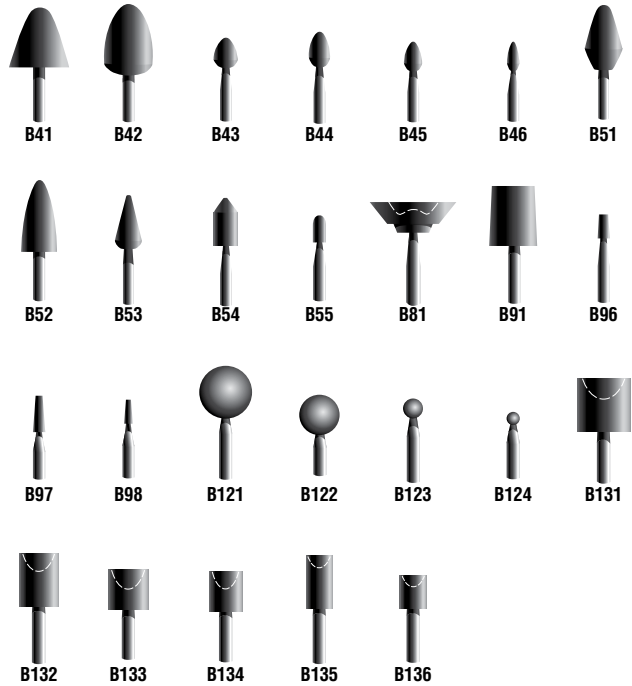

PART #	SHAPE	SIZE D X L	SPINDLE	GRADING	MAX. RPM	MIN/STD PKG.
"W" SHAPES – FOR MEDIUM TO HEAVY STOCK REMOVAL						
61463624488	W144	1/8 x 1/4	1/8	38A60-P	105,000	5/25
61463624489	W145	1/8 x 3/8	1/8	38A60-P	105,000	5/25
61463624491	W146	1/8 x 1/2	1/8	38A60-P	105,000	5/25
61463624495	W152	3/16 x 1/4	1/8	38A60-P	105,000	5/25
61463624496	W153	3/16 x 3/8	1/8	38A60-P	80,850	5/25
61463624497	W154	3/16 x 1/2	1/8	38A60-P	70,500	5/25
61463624501	W160	1/4 x 1/4	1/8	38A60-P	81,370	5/25
61463624503	W162	1/4 x 3/8	1/8	38A60-P	64,800	5/25
61463624504	W163	1/4 x 1/2	1/8	38A60-P	60,000	5/25
61463624505	W164	1/4 x 3/4	1/8	38A60-P	45,900	5/25
61463624511	W170	5/16 x 1/2	1/8	38A60-P	52,500	5/25
61463624516	W175	3/8 x 3/8	1/8	38A60-P	54,000	5/25
61463624517	W176	3/8 x 1/2	1/8	38A60-P	45,370	5/25
61463624518	W177	3/8 x 3/4	1/8	38A60-P	33,750	5/25
61463624525	W185	1/2 x 1/2	1/8	38A60-P	34,500	5/25
61463624526	W185	1/2 x 1/2	1/4	38A60-P	61,500	5/25
61463624528	W186	1/2 X 3/4	1/4	38A60-P	51,000	5/25
61463624530	W188	1/2 x 1-1/2	1/4	38A60-P	30,370	5/25
61463624531	W189	1/2 x 2	1/4	38A60-P	24,000	5/25

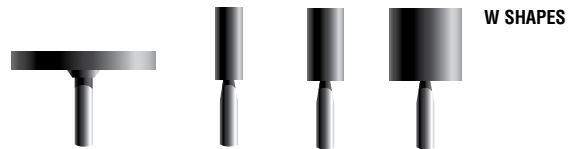

PART #	SHAPE	SIZE D X L	SPINDLE	GRADING	MAX. RPM	MIN/STD PKG.
"W" SHAPES – FOR MEDIUM TO HEAVY STOCK REMOVAL						
61463624539	W196	5/8 x 1	1/4	38A60-P	35,250	5/25
61463624543	W200	3/4 x 1/8	1/8	38A60-P	50,930	5/25
61463624544	W200	3/4 x 1/8	1/8	38A90-Q	50,930	5/25
61463624549	W204	3/4 x 3/4	1/4	38A60-P	42,750	5/25
61463624550	W205	3/4 x 1	1/4	38A60-P	34,500	5/25
61463624553	W208	3/4 x 2	1/4	38A60-P	18,750	5/25
61463624560	W215	1 x 1/8	1/8	38A60-P	38,200	5/25
61463624562	W216	1 x 1/4	1/4	38A60-P	38,200	5/25
61463624564	W218	1 x 1/2	1/4	38A60-P	38,200	5/25
61463624566	W220	1 x 1	1/4	38A60-P	25,500	5/25
61463624567	W221	1 x 1-1/2	1/4	38A60-P	19,120	5/25
61463624569	W222	1 x 2	1/4	38A60-P	15,900	5/25
61463624578	W230	1-1/4 x 1-1/4	1/4	38A60-P	20,400	5/25
61463624583	W235	1-1/2 x 1/4	1/4	38A60-P	25,470	5/25
61463624585	W236	1-1/2 x 1/2	1/4	38A60-P	25,470	5/25
61463624587	W237	1-1/2 x 1	1/4	38A60-P	22,500	5/25
61463624588	W238	1-1/2 x 1-1/2	1/4	38A60-P	15,600	5/25
61463624592	W242	2 x 1	1/4	38A60-P	19,100	5/25

Shank length is 1-1/2". Maximum operating speed based on 1/2" overhang.

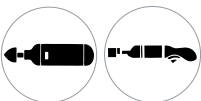

techtip

For best mounted point performance, always run the mounted point at the maximum allowable speed according to ANSI B7.1.

- Use 36 grit for rough grinding.
- Use 60 grit for imparting fine finishes or when grinding on narrow surfaces.



It is the user's responsibility to refer to and comply with ANSI B7.1

COMBINATION GRIT ABRASIVE SHARPENING STONES

Good Tier / Silicon Carbide or Aluminum Oxide

CARBO™



Silicon carbide combination benchstones have both coarse and fine grit silicon carbide surfaces. These fast-cutting stones are used to sharpen edges on tools to moderate tolerances quickly. Dark gray in color. Aluminum oxide combination benchstones have both coarse and fine grit aluminum oxide abrasive surfaces to produce strong, keen, long-lasting edges on quality tools. Orange/brown in color.

FEATURES	BENEFITS
<ul style="list-style-type: none"> • Sharp, silicon carbide abrasive 	<ul style="list-style-type: none"> • Enhanced cutting action • Fast stock removal
<ul style="list-style-type: none"> • Aluminum oxide abrasive 	<ul style="list-style-type: none"> • Fast, cool cutting action • Maintains high part tolerance
<ul style="list-style-type: none"> • Vitrified bond 	<ul style="list-style-type: none"> • Long life and excellent form holding

PART #	PRODUCT #	SIZE	GRIT SIZE	QTY. PKG./ CASE
CRYSTOLON (SILICON CARBIDE)				
05539509128	JB6	6 x 2 x 1	Coarse/Fine	1/5
05539509126	JB8	8 x 2 x 1	Coarse/Fine	1/5
INDIA (ALUMINUM OXIDE)				
05539509107	IB6	6 x 2 x 1	Coarse/Fine	1/5
05539509105	iB8	8 x 2 x 1	Coarse/Fine	1/5



DRESSING AND FINISHING STICKS

Good Tier / Silicon Carbide or Aluminum Oxide

CARBO™



Aluminum oxide dressing sticks work best on cBN grinding wheels, but can also be used on diamond grinding wheels.

Silicon carbide dressing sticks in coarse grit sizes and hard grades are used for dressing conventional vitrified wheels. Silicon carbide dressing sticks in fine grit sizes and softer grades are used for dressing diamond wheels.

FEATURES	BENEFITS
<ul style="list-style-type: none"> • Aluminum oxide abrasive – white 	<ul style="list-style-type: none"> • Free dressing action
<ul style="list-style-type: none"> • Silicon carbide abrasive – black 	<ul style="list-style-type: none"> • Sharp, durable
<ul style="list-style-type: none"> • Vitrified bond 	<ul style="list-style-type: none"> • Excellent conformability

PART #	SIZE THICKNESS X WIDTH X LENGTH	GRIT SIZE	QTY. PKG./ CASE
ALUMINUM OXIDE			
05539507214	3/4 x 3/4 x 4	AA150-HV40	5
05539507211	1/2 x 1/2 x 6	AA220-HV40	5
05539507232	1 x 1 x 6	AA220-HV40	5
SILICON CARBIDE			
05539507224	1 x 1 x 6	C220-KVGC	5



techtip

Selecting the appropriate dressing stick for each application depends on the wheel size, type, speed, grit size, and specification, as well as the work piece material. Initial starting specifications are listed below.

- For Resin Bond Diamond and cBN Wheels: Choose a dressing stick one or two grit sizes finer than the abrasive in the wheel – in a soft grade (H or I). Example: for a 100 or 120 grit resin bond wheel, choose a 150 grit dressing stick, and for a 150 or 220 grit resin bond wheel, choose a 220 grit dressing stick



MEDALIST SINGLE POINT DIAMOND DRESSING TOOLS

Good Tier / For Ceramic Wheels



Designed to dress and true harder ceramic toolroom wheels.

FEATURES	BENEFITS
<ul style="list-style-type: none"> Specially selected broad-shaped, diamond 	<ul style="list-style-type: none"> Withstands the increased grinding pressures of ceramic abrasives
<ul style="list-style-type: none"> Each diamond is hand selected for stone shape, quality and structural integrity 	<ul style="list-style-type: none"> Consistent tool performance
<ul style="list-style-type: none"> Multi-purpose 	<ul style="list-style-type: none"> Accommodate most straight dressing and simple form dressing applications Stand up to ceramic abrasive sharpness; can also be used to dress conventional abrasives

PART #	PRODUCT #	FOR WHEEL DIAMETER	TOOL CARAT WEIGHT	TOOL DIAMETER	TOOL LENGTH
SINGLE POINT TOOLS FOR TRUING/DRESSING CERAMIC WHEELS (NON RESETTABLE)					
07958787451	MED2M6	Up to 7"	1/4 (0.25)	3/8"	2"
07958787452	MED2M7	Up to 7"	1/4 (0.25)	7/16"	2"
07958787453	MED3M6	8" to 10"	1/3 (0.33)	3/8"	2"
07958787454	MED3M7	8" to 10"	1/3 (0.33)	7/16"	2"
07958787455	MED5M6	11" to 14"	1/2 (0.50)	3/8"	2"
07958787456	MED5M7	11" to 14"	1/2 (0.50)	7/16"	2"

WHEEL FORMS DRESSED BY THESE TOOLS



SINGLE POINT DIAMOND DRESSING TOOLS

Good Tier / For Aluminum Oxide Wheels



Designed to dress and true conventional aluminum oxide toolroom wheels.

FEATURES	BENEFITS
<ul style="list-style-type: none"> Consistent diamond structure and shape 	<ul style="list-style-type: none"> Repeatable dressing performance
<ul style="list-style-type: none"> Well defined, sharp diamond point 	<ul style="list-style-type: none"> Durable; maximum cost effectiveness for dressing conventional abrasives
<ul style="list-style-type: none"> Steeper 60 degree included angle head design 	<ul style="list-style-type: none"> Greater machine and part clearance produce forms with tighter tolerances

PART #	PRODUCT #	FOR WHEEL DIAMETER	TOOL CARAT WEIGHT	TOOL DIAMETER	TOOL LENGTH
SINGLE POINT TOOLS FOR TRUING/DRESSING ALUMINUM OXIDE WHEELS (NON RESETTABLE)					
07958787457	CA2-6	Up to 7"	1/4 (0.25)	3/8"	2"
07958787458	CA2-7	Up to 7"	1/4 (0.25)	7/16"	2"
07958787459	CA3-6	8" to 10"	1/3 (0.33)	3/8"	2"
07958787461	CA3-7	8" to 10"	1/3 (0.33)	7/16"	2"
07958787462	CA5-6	11" to 14"	1/2 (0.50)	3/8"	2"
07958787463	CA5-7	11" to 14"	1/2 (0.50)	7/16"	2"

WHEEL FORMS DRESSED BY THESE TOOLS



techtip

SINGLE-POINT TOOLS

- Rigidly mount single point tools at a 10° - 15° angle to the wheel centerline with a line drawn through the center of the wheel, pointing in the direction of wheel travel.
- Point of contact should be slightly below centerline of wheel as shown.
- Use coolant whenever possible.
- Normal infeed is .001" per pass.
- Lead selections range from .002" - .010" per wheel revolution.
- Rotate the tool 1/4 turn periodically to maintain a sharp point.

To optimize applications using ceramic abrasives and/or tools, normal dressing parameters must change. Reduce infeed by 25%. Significant reductions in the amount of infeed and frequency of dress will result in substantially lower cost per part ground.

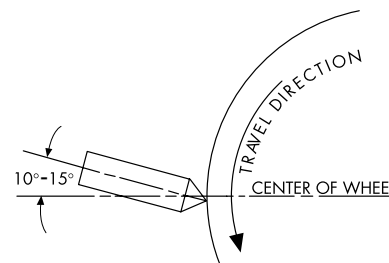

MEDALIST MULTI-POINT DIAMOND DRESSING TOOLS

Best Tier / For Ceramic Wheels



Multi-Point tools for ceramic toolroom wheels include a higher concentration of diamonds to withstand the increased diamond pressure generated by ceramic wheels.

FEATURES	BENEFITS
<ul style="list-style-type: none"> Uniformly distributed diamonds in a tough, durable matrix 	<ul style="list-style-type: none"> Consistent performance throughout tool life
<ul style="list-style-type: none"> Fresh, multiple diamond points exposed in truing operation; no turning or resetting required 	<ul style="list-style-type: none"> Faster, more consistent straight face dressing with maximum efficiency and longer tool life than single point tools
<ul style="list-style-type: none"> Overall diamond weight exceeds equivalent single point tool 	<ul style="list-style-type: none"> The most economical way to dress straight and tapered forms

PART #	PRODUCT #	FOR WHEEL DIAMETER	WHEEL GRIT SIZE	TOOL DIAMETER	APPROACH ANGLE
MULTI-POINT TOOLS FOR TRUING/DRESSING CERAMIC WHEELS					
07958787464	MED1R6J7	Up to 10"	54 to 100	7/16"	0 degrees
07958787465	MED2R6K7	11" to 14"	54 to 100	7/16"	0 degrees

WHEEL FORMS DRESSED BY THESE TOOLS

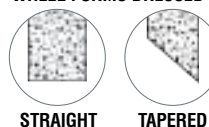

STRAIGHT TAPERED

MULTI-POINT DIAMOND DRESSING TOOLS

Good Tier / For Aluminum Oxide Wheels



Multi-Point tools for aluminum oxide toolroom wheels are the ideal selection of general purpose tools for use on conventional abrasives on a broad range of dressing applications.

FEATURES	BENEFITS
<ul style="list-style-type: none"> Uniformly distributed diamonds in a tough, durable matrix 	<ul style="list-style-type: none"> Consistent performance throughout tool life
<ul style="list-style-type: none"> Fresh, multiple diamond points exposed in truing operation; no turning or resetting required 	<ul style="list-style-type: none"> Faster, more consistent straight face dressing with maximum efficiency and longer tool life than single point tools
<ul style="list-style-type: none"> Overall diamond weight exceeds equivalent single point tool 	<ul style="list-style-type: none"> The most economical way to dress straight and tapered forms

PART #	PRODUCT #	FOR WHEEL DIAMETER	WHEEL GRIT SIZE	TOOL DIAMETER	APPROACH ANGLE
MULTI-POINT TOOLS FOR TRUING/DRESSING ALUMINUM OXIDE WHEELS					
07958787466	CA64	Up to 10"	54 to 100	7/16"	0 degrees
07958787467	CA65	11" to 14"	54 to 100	7/16"	0 degrees

WHEEL FORMS DRESSED BY THESE TOOLS



STRAIGHT TAPERED

techtip

MULTI-POINT TOOLS – STRAIGHT FACE DRESSING AND TRUING

- Most multi-point tools are used for straight face dressing.
- Tool should have full face contact with the wheel.
- With new tool, 3–5 passes at .005" per pass should be taken to expose diamonds.
- Infeed per pass .001" - .002"
- Use coolant whenever possible.
- Use appropriate lead (and traverse rate).

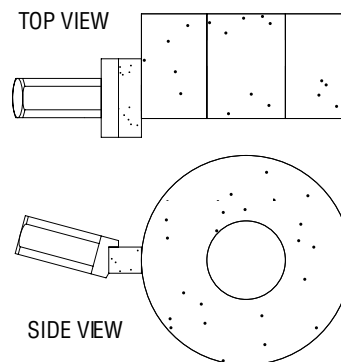

HOW TO READ A BONDED ABRASIVE SPECIFICATION

Wheel Symbols and Markings: Carborundum abrasive wheels are marked according to the system which is standard throughout the industry. This standard marking system consists of six positions. The characters in each position denote a specific characteristic of the wheel.

BONDED ABRASIVE TERMINOLOGY KEY

Position 1	Position 2	Position 3	Position 4	Position 5	Position 6
AA	46	K	8	V	40
ABRASIVE	GRIT SIZE	GRADE	STRUCTURE	BOND TYPE	BOND MODIFICATION
MEDALIST - BLUE CERAMIC ALUMINA	COARSE	SOFT	DENSE	V - VITRIFIED	40
MEDALIST R - PURPLE CERAMIC ALUMINA	14	F	1	B - RESINOID	P = Porous
MZ - CERAMIC ALUMINA/ZA BLEND	46	G	2	RR - RUBBER	
32AR - GRAY/PURPLE ALUMINUM OXIDE	16	H	3		
38A - ALUMINUM OXIDE	54	I	4		
A - ALUMINUM OXIDE	60	J	5		
AA - WHITE ALUMINUM OXIDE	70	K	6		
AR - RUBY ALUMINUM OXIDE	80	L	8		
AZ - ZA/AO BLEND	100	M	9		
BA - ALUMINUM OXIDE	120	N	10		
DA - GRAY ALUMINUM OXIDE BLEND	150	O	11		
GA - ALUMINUM OXIDE		P	12		
GRA - GA/RA BLEND		Q			
PA - PINK ALUMINUM OXIDE		R			
RA - PINK/PURPLE ALUMINUM OXIDE		S			
RG		T			
RG		U			
37C - BLACK SILICON CARBIDE		V			
C - BLACK SILICON CARBIDE					
CA - BLACK SILICON CARBIDE					
CGA - ALUMINUM OXIDE/SILICON CARBIDE BLEND					
DAC - ALUMINUM OXIDE/SILICON CARBIDE BLEND					
GC - GREEN SILICON CARBIDE					
Z - ZIRCONIA ALUMINA					
AZA - ZA/AO BLEND					
ZA - ZA/AO BLEND					
2ZA - ZA/GA BLEND					
2ZC - ZA/C BLEND					
3AZA - ZIRCONIA ALUMINA/ALUMINUM OXIDE BLEND					
3ZA - ZIRCONIA ALUMINA/ALUMINUM OXIDE BLEND					
NORZON - PREMIUM ZIRCONIA ALUMINA					
PR - ZIRCONIA ALUMINA					
CHARGER - ZIRCONIA ALUMINA					



WHEEL SPEEDS – CONVERSION TABLE

Example: Find the machine RPMs. This should be written on the machine itself. For this example, assume that the machine RPM is 1,773 and that the wheel diameter is 14".

- Find the diameter of 14" in either the left-most or right-most column of the chart.
- Follow the row horizontally to RPM of 1,773 as this is the spindle speed of the machine.
- Follow column directly upwards to find SFPM of 6,500.

	SURFACE SPEED IN FEET PER MINUTE (SFPM)																	
	4,000	4,500	5,000	5,500	6,000	6,500	7,000	7,500	8,000	8,500	9,000	9,500	10,000	12,000	12,500	14,200	16,000	
REVOLUTIONS PER MINUTE (RPM)																		
1"	15,279	17,189	19,098	21,008	22,918	24,828	26,737	28,647	30,558	32,467	34,377	36,287	38,196	40,106	42,015	43,925	45,835	47,745
2"	7,639	8,594	9,549	10,504	11,459	12,414	13,368	14,323	15,278	16,233	17,188	18,143	19,098	20,053	21,008	21,963	22,918	23,873
3"	5,093	5,729	6,366	7,003	7,639	8,276	8,913	9,550	10,187	10,824	11,461	12,098	12,735	13,372	14,009	14,646	15,283	15,920
4"	3,820	4,297	4,775	5,252	5,729	6,207	6,684	7,162	7,640	8,118	8,595	9,073	9,551	10,028	10,506	10,984	11,462	11,940
5"	3,056	3,438	3,820	4,202	4,584	4,966	5,348	5,730	6,112	6,494	6,876	7,258	7,640	8,022	8,404	8,786	9,168	9,550
6"	2,546	2,865	3,183	3,501	3,820	4,138	4,456	4,775	5,092	5,411	5,729	6,048	6,366	6,684	7,003	7,321	7,640	7,958
7"	2,183	2,455	2,728	3,001	3,274	3,547	3,820	4,092	4,366	4,638	4,911	5,183	5,456	5,728	6,001	6,274	6,547	6,820
8"	1,910	2,148	2,387	2,626	2,865	3,103	3,342	3,580	3,820	4,058	4,297	4,535	4,775	5,013	5,252	5,491	5,730	5,969
9"	1,698	1,910	2,122	2,334	2,546	2,758	2,970	3,182	3,394	3,606	3,818	4,030	4,242	4,454	4,666	4,878	5,090	5,302
10"	1,528	1,719	1,910	2,101	2,292	2,483	2,674	2,865	3,056	3,247	3,438	3,629	3,820	4,011	4,202	4,393	4,584	4,775
12"	1,273	1,432	1,591	1,751	1,910	2,069	2,228	2,387	2,546	2,705	2,864	3,023	3,183	3,342	3,501	3,660	3,819	3,978
14"	1,091	1,228	1,364	1,500	1,637	1,773	1,910	2,046	2,182	2,319	2,455	2,592	2,728	2,864	3,001	3,137	3,274	3,410
16"	955	1,074	1,194	1,313	1,432	1,552	1,672	1,791	1,910	2,029	2,149	2,268	2,387	2,506	2,625	2,744	2,863	2,982
18"	849	955	1,061	1,167	1,273	1,379	1,485	1,591	1,698	1,803	1,910	2,016	2,120	2,226	2,332	2,438	2,544	2,650
20"	764	859	955	1,050	1,146	1,241	1,337	1,432	1,528	1,623	1,719	1,814	1,910	1,999	2,095	2,190	2,286	2,382
22"	694	781	868	955	1,042	1,128	1,215	1,303	1,388	1,476	1,562	1,649	1,736	1,822	1,909	1,996	2,083	2,170
24"	637	716	796	875	955	1,034	1,115	1,194	1,274	1,353	1,433	1,512	1,591	1,670	1,750	1,829	1,908	1,987
26"	588	661	734	808	881	955	1,028	1,101	1,176	1,248	1,322	1,395	1,468	1,542	1,615	1,689	1,762	1,836
28"	546	614	682	750	818	887	955	1,023	1,092	1,159	1,228	1,296	1,364	1,433	1,501	1,570	1,638	1,707
30"	509	573	637	700	764	828	891	955	1,018	1,082	1,146	1,210	1,274	1,338	1,402	1,466	1,530	1,594

Note: The calculated RPM figures listed above are rounded off to the next higher 5 for wheel marking purposes. For intermediate diameters not listed, use the formula listed in Section 1.2.10 of ANSI B7.1 (SFPM = .262 x wheel diameter in inches x RPM) Note: SFPM ÷ 1.60934 = m/s (meters per second)

ABRASIVE GRAINS

The abrasive grains (ceramic alumina, zirconia alumina, aluminum oxide and silicon carbide) perform the cutting action. An ideal grinding abrasive has the ability to fracture before serious dulling occurs and offers maximum resistance to point wear. Each abrasive has special crystal structure and fracture characteristics, making it suitable for grinding operations on specific materials.

Medalist – Ceramic Alumina

A superior performing grain for high temperature alloys such as Inconel, Waspalloy and Haspalloy, hardened tool steels, spray metal or Stellite and other hardened steels.

Zirconia Alumina

A tough, sharp abrasive designed for optimum performance in cut-off wheels, snagging wheels and depressed center wheels for grinding or cutting cast steel, alloy steel, and malleable and ductile iron.

Aluminum Oxide

A tough, sharp grain produced under controlled conditions and especially adapted to grinding or cutting materials of high tensile strength, such as alloy steel, high speed steel, annealed, malleable iron, and tough bronze.

Silicon Carbide

This is a very hard, sharp abrasive grain used in the grinding of tungsten carbide and low tensile strength materials such as cast iron, bronze, aluminum, copper, and non-metallic materials such as plastics, glass, marble, granite and stone.



GRADE

The grade is the strength of bonding of a grinding wheel, and is frequently referred to as its hardness. The higher the letter designation, the stronger the bond.

WHEEL STRUCTURES

Wheel structures (the spacing between grain particles) range from open to dense and vary with different grinding operations, depending upon the area of contact and type of material being ground, rate of stock removal and finish required. Carborundum offers standard structure wheels that will perform well on a wide range of materials.

BONDS

The purpose of the bonding material is to hold the abrasive grain particles together.

Vitrified Bonds

Vitrified wheels have a glass bond composition. Vitrified wheels hold form extremely well and produce a high ratio of stock removal to wheel use. Vitrified wheels are commonly used for precision grinding in the tool and die market.

Porosity

Vitrified wheels can be manufactured with induced porosity. All vitrified bonds that end in P (VLP, V40P, VPP) indicate induced porosity. This porosity allows excellent coolant flow and chip clearance. For materials that load or for wide surface area contact, this provides a cooler cutting action, less loading and less chance of burn on the workpiece.

Resinoid Bonds

Resinoid, or organic compound, bonds are more shock resistant than vitrified bonds and are generally operated at higher peripheral speeds. Most resinoid bond wheels are used for fast stock removal in the metal fabrication and foundry markets.

PROCEDURES FOR PROPER HANDLING AND STORAGE OF BONDED ABRASIVE PRODUCTS

HANDLING

All grinding wheels are relatively fragile and must be handled with care. This applies to all types of bonds: vitrified, resinoid and rubber.

Do:

- Inspect all wheels upon receipt.
- Use pallets or trucks to transport.
- Support firmly at all times.
- Place wheels carefully in racks.

Do Not:

- Leave wheels packed in absorbent material.
- Roll wheels on floor.
- Lean wheel against equipment.
- Place tools or parts on top of wheels.

STORAGE

Suitable racks, cradles and drawers should be provided to store the various types of wheels used.

Do:

- Store wheels correctly supported.
- Stack thin wheels flat.
- Ensure storage in dry conditions.

Do Not:

- Store in damp or humid conditions.
- Subject wheels to dramatic change in temperature.
- Subject wheels to temperatures at or approaching freezing.

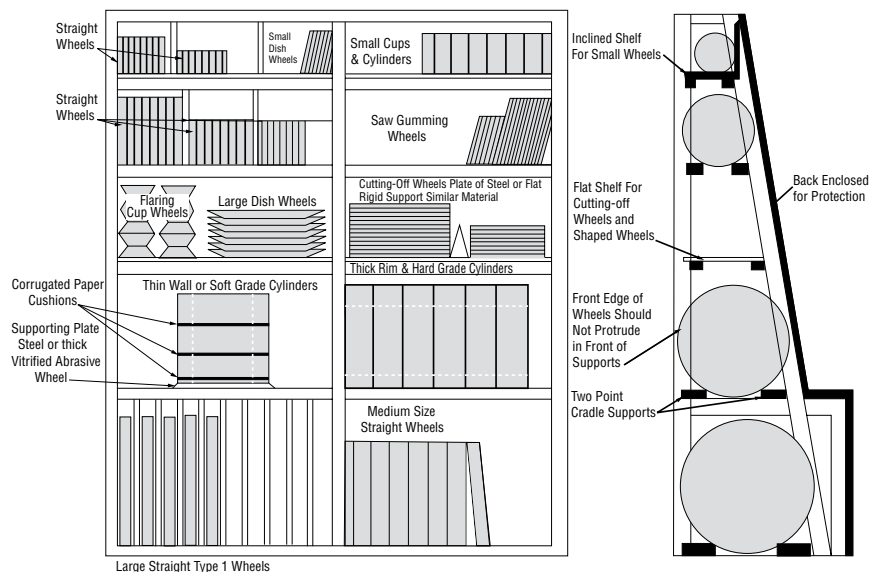



OBSERVE WIRE BRUSH SAFETY WARNINGS TO AVOID INJURY

Stainless brushes are made of 304L stainless steel with high chromium content to resist corrosion, high tensile resistance and lower carbon content. These brushes are suitable for all applications requiring corrosion resistance like the dairy, food processing, chemical processing and aircraft industries, among others.

1. **Safety Goggles:** Safety goggles or full face shields worn over safety glasses with side shields must be worn by all operators and others in the area of power brush operations. Comply with the requirements of ANSI Z87.1 "Occupational Eye and Face Protection".
2. **Guards:** Keep all machine guards in place.
3. **Speeds:** Observe all speed restrictions indicated on the brushes, containers, labels, or printed in pertinent literature. "MSFS" means Maximum Safe Free Speed (RPM) – free spinning wheel with no work applied. For reasons of safety, the MSFS should not be exceeded under any circumstance.
4. **Safety Standard:** Comply with the safety Standards of the Industrial Division of the American National Standards Institute ANSI B165.1 "Safety Requirements – Power Brushes" and refer to the "Safety" section in the carborundumabrasives.com web site.
5. **Protective Equipment:** Appropriate protective clothing and equipment (such as gloves, respirator, etc.) must be used.

Warning: In normal power brushing operations, the material being removed, such as burrs, scale, dirt, weld slag, or other residue, will fly off the brush with considerable force along with the brush filaments which break off due to fatigue.

The potential of serious injury exists for both the brush operator and others in the work area (possibly 50 or more feet from the brush). To protect against this hazard, before rotating the brush, operators and others in the area must wear SAFETY GOGGLES or FULL FACE SHIELDS WORN OVER SAFETY GLASSES WITH SIDE SHIELDS, along with PROTECTIVE CLOTHING.

KNOTTED WIRE CUP BRUSHES

Better Tier / Carbon



High-impact cutting and cleaning on more demanding applications such as heavy deburring, weld cleaning and cleaning larger surfaces.

FEATURES	BENEFITS
<ul style="list-style-type: none"> • Rigid structure • Available with or without plastic guard • Protective guard opens up into a shield 	<ul style="list-style-type: none"> • High impact cutting and cleaning • Application-specific • Prevents wire, dust and any kind of projection from reaching the end-user during work • Provides for a friendly handling of the brush, preventing potential pricking caused by the wire ends, for safety before, during and after work
<ul style="list-style-type: none"> • Knotted Cup – single row, twist knot construction 	<ul style="list-style-type: none"> • Limits flaring of the brush on corners and angles

PART #	BRUSH SIZE DIA. x WIRE SIZE x ARBOR HOLE	WIRE TYPE	MAX. RPM	BRUSHES/ BOX
FOR STEEL/METAL				
KNOTTED CUP WITH PROTECTIVE GUARD – SINGLE ROW				
66252844498	2-3/4 x .020 x 5/8-11	Carbon	15,000	1
KNOTTED CUP – SINGLE ROW				
66252844497	2-3/4 x .020 x 5/8-11	Carbon	15,000	1
66252844500	4 x .020 x 5/8-11	Carbon	9,000	1
66252844501	6 x .020 x 5/8-11	Carbon	6,000	1
Individually boxed.				



RED = FOR STEEL/METAL USE BLUE = FOR STAINLESS STEEL USE

CRIMPED WIRE CUP BRUSHES

Better Tier / Carbon



For light- to medium-duty brushing applications on flat or irregular surfaces, and bevel buffing.

FEATURES	BENEFITS
<ul style="list-style-type: none"> Highly flexible Heavy wire fill 	<ul style="list-style-type: none"> Fast cutting

PART #	BRUSH SIZE DIA. x WIRE SIZE x ARBOR HOLE	WIRE TYPE	MAX. RPM	BRUSHES/ BOX
FOR STEEL/METAL				
66252844499	3 x .014 x 5/8-11	Carbon	13,000	1
Individually boxed.				



END BRUSHES

Better Tier / Carbon



KNOTTED

CRIMPED

For use on die grinders to clean and deburr a recessed area or the inside diameter of a tube or pipe.

FEATURES	BENEFITS
<ul style="list-style-type: none"> Knot wire end brushes Crimped wire end brushes 	<ul style="list-style-type: none"> For more aggressive cutting For lighter brushing action and contoured surfaces

PART #	BRUSH SIZE DIA. x WIRE SIZE x ARBOR HOLE	WIRE TYPE	MAX. RPM	BRUSHES/ BOX
FOR STEEL/METAL				
STEM MOUNTED KNOTTED				
66252844510	1 x .020 x 1/4 Shank	Carbon	20,000	10
STEM MOUNTED CRIMPED				
66252844511	1 x .020 x 1/4 Shank	Carbon	20,000	10
Bulk packed.				



CRIMPED WIRE WHEEL BRUSHES

Better Tier / Carbon



Medium-faced brushes clean larger areas and have longer life. Brushes may be used individually or stacked on a shaft.

FEATURES	BENEFITS
<ul style="list-style-type: none"> Dense, high-quality, tempered crimped wire construction 	<ul style="list-style-type: none"> Offers excellent performance for deburring, removing rust, corrosion and dirt, or for surface preparation

PART #	BRUSH SIZE DIA. x WIRE SIZE x ARBOR HOLE	WIRE TYPE	MAX. RPM	BRUSHES/ BOX
FOR STEEL/METAL				
CRIMPED MEDIUM 3/4" FACE				
66252844508	6 x .014 x 1/2-2	Carbon	6,500	1
66252844509	8 x .014 x 1/2-2	Carbon	4,500	1
7 bushing sizes are included with each brush.				
Individually boxed.				



RED = FOR STEEL/METAL USE **BLUE = FOR STAINLESS STEEL USE**

FULL CABLE TWIST KNOT WIRE WHEEL BRUSHES

Better Tier / Carbon



For the tougher applications, especially for weld passes or other demanding applications.

FEATURES & BENEFITS

- Full cable twist knot brushes provide very low flex and high impact cutting and cleaning

PART #	BRUSH SIZE DIA. x WIRE SIZE x ARBOR HOLE	WIRE TYPE	MAX. RPM	BRUSHES/ BOX
FOR STEEL/METAL				
66252844504	4-1/2 x .020 x 5/8-11	Carbon	20,000	5

Bulk packed.



STRINGER BEAD KNOT WIRE WHEEL BRUSHES

Better Tier / Stainless or Carbon



Specially suited for groove and weld bead, corners and t-connections.

FEATURES & BENEFITS

- Narrow face stringer bead wire delivers high-impact cutting and cleaning for toughest applications
- Joint/Crack cleaning wire wheel brushes used for brushing joints, cleaning cracks in concrete and asphalt, and preparing expansion joints for filling and scaling
- Powder-coated and color-coated hubs prevent cross-contamination and rust

PART #	BRUSH SIZE DIA. x WIRE SIZE x ARBOR HOLE	WIRE TYPE	MAX. RPM	BRUSHES/ BOX
FOR STAINLESS STEEL				
FOR RIGHT ANGLE GRINDERS				
66252844503	4 x .020 x 5/8-11	Stainless	20,000	12
FOR STEEL/METAL				
FOR RIGHT ANGLE GRINDERS				
66252844502	4 x .020 x 5/8-11	Carbon	20,000	5
66253370022	4 x .020 x 5/8-11 Economy	Carbon	20,000	10
66252844505	6 x .020 x 5/8-11	Carbon	12,500	10
66252844506	6-7/8 x .020 x 5/8-11	Carbon	9,000	10
FOR WALK-BEHIND MACHINES – JOINT/CRACK CLEANING BRUSHES				
66252844507	12 x .035 x 1 - DP	Carbon	4,500	2

Bulk packed.



RED = FOR STEEL/METAL USE **BLUE = FOR STAINLESS STEEL USE**

HAND BRUSHES

Better Tier / Stainless or Carbon



Narrow brush allows access into tight areas and slots. Curved face for hard-to-reach places. Color-coded handles prevent cross-contamination and rust.

FEATURES

- Long handle and shoe handle brushes

BENEFITS

- Steel scratch brushes are made with high-carbon brass-coated steel; red handle
- Stainless steel brushes are made with a 304L stainless steel; blue handle

PART #	BRUSH SIZE	WIRE TYPE	BRUSHES/ BOX
FOR STAINLESS STEEL			
HAND BRUSHES			
66252844514	Scratch Brush 3 x 19 Long Handle	Stainless	12
66252844516	Scratch Brush 4 x 16 Shoe Handle	Stainless	12
66252844512	Inspection Brush 3 x 7	Stainless	36
FOR STEEL/METAL			
HAND BRUSHES			
66252844513	Scratch Brush 3 x 19 Long Handle	Carbon	12
66252844515	Scratch Brush 4 x 16 Shoe Handle	Carbon	12
Bulk packed.			



RED = FOR STEEL/METAL USE **BLUE = FOR STAINLESS STEEL USE**

PART # TO PAGE CROSS REFERENCE

PART #	PAGE	PART #	PAGE	PART #	PAGE	PART #	PAGE	PART #	PAGE	PART #	PAGE	PART #	PAGE
05539500471	118	05539500544	117	05539503588	8	05539509128	155	05539509570	147	05539509929	149	05539510712	21
05539500472	118	05539500545	117	05539503589	8	05539509134	135	05539509572	147	05539509934	148	05539510713	21
05539500473	118	05539500546	117	05539503594	8	05539509136	135	05539509573	147	05539509935	148	05539510720	21
05539500474	118	05539500547	117	05539503861	13	05539509137	135	05539509575	147	05539509937	148	05539510721	21
05539500475	118	05539500548	117	05539503863	13	05539509138	135	05539509576	147	05539509938	148	05539510722	21
05539500476	118	05539500694	132	05539504270	13	05539509139	135	05539509578	147	05539509939	148	05539510793	73
05539500478	118	05539501900	143	05539504701	6	05539509141	135	05539509580	147	05539509941	148	05539510794	73
05539500479	118	05539501923	12	05539504702	6	05539509142	135	05539509581	147	05539509947	148	05539510795	73
05539500480	118	05539501926	12	05539504703	6	05539509143	135	05539509582	147	05539509948	148	05539510796	73
05539500481	118	05539502833	8	05539504706	6	05539509144	135	05539509585	147	05539509950	148	05539510797	73
05539500482	118	05539502834	8	05539504708	6	05539509145	135	05539509777	143	05539509952	148	05539510798	73
05539500483	118	05539502836	7	05539504709	8	05539509149	135	05539509781	143	05539509953	148	05539510808	72
05539500484	118	05539502837	7	05539504710	8	05539509150	135	05539509782	143	05539509955	148	05539510810	72
05539500485	118	05539502838	8	05539504711	8	05539509152	135	05539509783	143	05539509956	148	05539510812	72
05539500486	118	05539502839	8	05539504712	8	05539509153	135	05539509790	143	05539509959	148	05539510813	72
05539500488	119	05539502842	7	05539504714	8	05539509154	135	05539509792	143	05539509960	148	05539510814	72
05539500489	119	05539502843	7	05539504716	8	05539509155	132	05539509793	143	05539509961	148	05539510815	72
05539500490	119	05539502844	8	05539504717	8	05539509156	132	05539509796	143	05539509964	148	05539510816	72
05539500491	119	05539502846	7	05539504718	8	05539509159	132	05539509798	143	05539509965	148	05539510817	72
05539500492	119	05539502847	7	05539506618	131	05539509160	132	05539509803	143	05539509966	148	05539510818	72
05539500493	119	05539502848	8	05539507043	150	05539509162	132	05539509804	143	05539509971	148	05539510819	72
05539500494	119	05539502849	7	05539507044	150	05539509166	132	05539509806	143	05539509972	144	05539510843	74
05539500495	119	05539502850	8	05539507047	150	05539509167	131	05539509807	143	05539509972	148	05539510844	74
05539500497	119	05539502851	8	05539507048	150	05539509169	131	05539509810	143	05539509973	148	05539510845	74
05539500500	119	05539502853	7	05539507054	17	05539509181	12	05539509814	143	05539509974	148	05539510846	74
05539500501	119	05539502854	7	05539507061	17	05539509183	12	05539509827	143	05539509975	148	05539510847	74
05539500502	119	05539502855	8	05539507063	17	05539509184	12	05539509836	143	05539509976	148	05539510848	74
05539500503	119	05539502856	8	05539507065	17	05539509185	12	05539509839	143	05539509978	148	05539510849	74
05539500504	119	05539502857	7	05539507066	17	05539509186	12	05539509840	143	05539510141	67	05539510850	74
05539500505	119	05539502858	7	05539507067	17	05539509187	12	05539509841	143	05539510340	67	05539510851	74
05539500506	119	05539502859	7	05539507068	17	05539509188	12	05539509844	143	05539510516	32	05539510852	74
05539500507	119	05539502860	7	05539507069	17	05539509192	12	05539509848	143	05539510517	32	05539510853	74
05539500508	119	05539502861	7	05539507070	17	05539509194	12	05539509852	143	05539510521	32	05539510854	74
05539500509	119	05539502862	7	05539507071	17	05539509195	12	05539509854	143	05539510522	32	05539510861	74
05539500515	119	05539502863	6	05539507072	17	05539509196	12	05539509857	143	05539510523	32	05539510862	74
05539500516	119	05539502864	6	05539507079	18	05539509197	12	05539509858	143	05539510525	32	05539510868	74
05539500517	119	05539502865	6	05539507080	18	05539509204	17	05539509859	143	05539510526	32	05539510870	74
05539500518	119	05539502867	6	05539507082	18	05539509216	17	05539509860	143	05539510539	32	05539510871	74
05539500519	119	05539502868	6	05539507083	18	05539509238	14	05539509862	143	05539510540	32	05539510872	74
05539500520	119	05539502870	6	05539507085	18	05539509243	14	05539509863	143	05539510545	31	05539510873	74
05539500521	119	05539502871	6	05539507086	18	05539509249	14	05539509864	143	05539510546	31	05539510874	74
05539500522	119	05539502872	6	05539507087	18	05539509252	13	05539509865	143	05539510548	31	05539510875	74
05539500523	119	05539502873	6	05539507088	18	05539509254	13	05539509866	143	05539510549	31	05539510876	74
05539500524	119	05539502874	6	05539507176	132	05539509255	13	05539509874	143	05539510550	31	05539510885	74
05539500525	119	05539502876	6	05539507177	133	05539509257	13	05539509875	143	05539510552	31	05539510886	74
05539500526	119	05539502877	6	05539507181	133	05539509258	13	05539509907	136	05539510553	31	05539510887	74
05539500527	119	05539502878	6	05539507182	132	05539509260	13	05539509911	149	05539510554	31	05539510898	78
05539500528	119	05539502879	6	05539507183	133	05539509261	13	05539509912	149	05539510555	31	05539510899	78
05539500529	119	05539502881	6	05539507211	155	05539509262	13	05539509913	149	05539510557	31	05539510900	78
05539500533	119	05539502882	6	05539507214	155	05539509263	13	05539509914	149	05539510558	31	05539510902	78
05539500534	108	05539502883	6	05539507224	155	05539509264	13	05539509915	149	05539510560	31	05539510903	78
05539500535	108	05539502884	6	05539507232	155	05539509265	13	05539509916	149	05539510561	31	05539510904	78
05539500536	108	05539502889	6	05539507347	131	05539509268	13	05539509920	149	05539510562	31	05539510905	78
05539500537	108	05539502890	6	05539507349	6	05539509269	13	05539509922	149	05539510563	31	05539510906	78
05539500538	109	05539502892	6	05539508158	8	05539509275	13	05539509924	149	05539510565	31	05539510907	78
05539500539	109	05539503507	13	05539508397	132	05539509276	13	05539509925	149	05539510566	31	05539510908	78
05539500541	117	05539503508	13	05539509105	155	05539509277	13	05539509926	149	05539510567	31	05539510945	67
05539500542	117	05539503509	13	05539509107	155	05539509564	147	05539509927	149	05539510585	67	05539510947	67
05539500543	117	05539503517	143	05539509126	155	05539509566	147	05539509928	149	05539510711	21	05539510988	75

PART # TO PAGE CROSS REFERENCE

PART #	PAGE	PART #	PAGE	PART #	PAGE	PART #	PAGE	PART #	PAGE	PART #	PAGE		
05539511102	67	05539518108	30	05539520122	40	05539520321	42	05539520891	134	05539527271	140	05539527354	141
05539511103	75	05539518109	30	05539520123	40	05539520322	42	05539520893	134	05539527272	140	05539527355	141
05539511143	75	05539518110	30	05539520125	40	05539520323	42	05539521300	33	05539527273	140	05539527356	141
05539512013	79	05539518111	30	05539520126	40	05539520324	42	05539521301	33	05539527274	140	05539527359	141
05539512014	79	05539518112	30	05539520129	40	05539520325	42	05539521302	33	05539527275	140	05539527360	141
05539512015	79	05539518113	30	05539520130	40	05539520326	42	05539521303	33	05539527276	140	05539527361	141
05539512023	32	05539518114	30	05539520131	40	05539520328	42	05539521304	33	05539527277	140	05539527362	141
05539512023	48	05539518162	30	05539520132	40	05539520329	42	05539521305	33	05539527279	140	05539527364	141
05539512030	41	05539518163	30	05539520133	40	05539520330	42	05539521309	35	05539527280	140	05539527365	141
05539512032	22	05539518164	30	05539520134	40	05539520331	42	05539521311	35	05539527282	140	05539527368	141
05539512032	113	05539518165	30	05539520252	39	05539520332	69	05539521315	41	05539527283	140	05539527369	141
05539512033	22	05539518166	30	05539520253	39	05539520333	69	05539521316	41	05539527284	140	05539527370	141
05539512033	113	05539518167	30	05539520254	39	05539520334	69	05539521318	41	05539527287	140	05539527371	141
05539512307	75	05539518168	30	05539520255	39	05539520335	69	05539521319	41	05539527290	140	05539527372	141
05539512308	75	05539518169	30	05539520256	39	05539520336	69	05539521320	41	05539527291	140	05539527460	127
05539512310	75	05539518170	30	05539520257	39	05539520337	69	05539521324	44	05539527292	140	05539527673	141
05539512312	75	05539518171	30	05539520258	39	05539520338	69	05539521325	44	05539527293	140	05539527675	142
05539512313	75	05539518172	30	05539520259	39	05539520339	69	05539521333	46	05539527294	140	05539527677	142
05539512314	75	05539518173	30	05539520260	39	05539520340	69	05539521334	46	05539527295	140	05539527678	142
05539512315	75	05539518610	26	05539520262	39	05539520345	26	05539521335	46	05539527296	140	05539527679	142
05539512316	75	05539518613	26	05539520263	39	05539520346	26	05539521336	76	05539527298	140	05539527680	142
05539512549	33	05539518615	26	05539520264	39	05539520347	26	05539521337	76	05539527300	140	05539527681	142
05539512550	33	05539518616	26	05539520266	39	05539520348	26	05539521338	76	05539527301	140	05539527682	142
05539512551	33	05539518617	26	05539520267	39	05539520361	36	05539521339	76	05539527302	140	05539527683	142
05539512556	33	05539518619	26	05539520269	39	05539520470	77	05539521342	77	05539527303	140	05539527684	142
05539512557	33	05539518620	26	05539520270	39	05539520471	77	05539521343	77	05539527305	140	05539527685	142
05539512568	22	05539518621	26	05539520271	39	05539520472	77	05539521344	77	05539527306	140	05539527686	141
05539512658	127	05539518622	26	05539520272	39	05539520473	77	05539521345	77	05539527308	140	05539527688	141
05539512667	127	05539518623	26	05539520274	39	05539520474	77	05539521348	78	05539527311	141	05539527689	141
05539512677	127	05539518624	26	05539520275	39	05539520475	77	05539521349	78	05539527312	141	05539527692	141
05539513710	80	05539518626	26	05539520276	39	05539520520	41	05539521350	78	05539527314	141	05539527696	141
05539513711	80	05539518627	26	05539520277	39	05539520521	41	05539526627	127	05539527315	141	05539527697	141
05539513712	80	05539518628	26	05539520278	39	05539520523	69	05539527164	110	05539527317	141	05539527700	141
05539514148	71	05539518629	26	05539520282	39	05539520526	71	05539527224	15	05539527318	141	05539527703	142
05539514745	63	05539518631	26	05539520283	39	05539520527	71	05539527225	15	05539527319	141	05539527704	142
05539515282	34	05539518632	26	05539520284	39	05539520528	71	05539527226	15	05539527320	141	05539527705	142
05539515284	34	05539518633	26	05539520285	39	05539520529	71	05539527228	15	05539527321	141	05539527707	142
05539515286	34	05539518634	26	05539520287	39	05539520530	71	05539527230	15	05539527322	141	05539527714	143
05539515287	34	05539518635	26	05539520288	39	05539520531	71	05539527241	140	05539527323	141	05539527716	143
05539515291	34	05539518638	26	05539520289	39	05539520532	71	05539527242	140	05539527326	141	05539528044	144
05539515292	34	05539518639	26	05539520291	30	05539520533	71	05539527243	140	05539527327	141	05539528045	20
05539515293	34	05539518640	26	05539520292	30	05539520534	71	05539527244	140	05539527328	141	05539528046	20
05539515294	34	05539518641	26	05539520293	30	05539520535	71	05539527245	140	05539527329	141	05539528047	20
05539515295	34	05539518642	26	05539520294	30	05539520536	71	05539527247	140	05539527331	141	05539529311	67
05539515297	34	05539518986	12	05539520295	30	05539520537	71	05539527248	140	05539527334	141	05539529312	67
05539515298	34	05539520019	21	05539520296	30	05539520538	71	05539527249	140	05539527335	141	05539529313	67
05539515300	34	05539520034	21	05539520299	36	05539520615	30	05539527250	140	05539527337	141	05539529314	67
05539515304	34	05539520055	21	05539520305	42	05539520619	30	05539527251	140	05539527338	141	05539529315	67
05539515311	34	05539520069	21	05539520306	42	05539520620	30	05539527252	140	05539527339	141	05539529316	67
05539515312	34	05539520076	21	05539520307	42	05539520623	30	05539527255	140	05539527340	141	05539529317	67
05539515313	34	05539520077	21	05539520310	42	05539520624	30	05539527256	140	05539527341	141	05539529318	67
05539515315	34	05539520086	21	05539520311	42	05539520765	48	05539527257	140	05539527342	141	05539529319	67
05539515316	34	05539520087	21	05539520312	42	05539520766	48	05539527260	140	05539527343	141	05539529320	67
05539515317	34	05539520088	21	05539520313	42	05539520767	48	05539527261	140	05539527344	141	05539529321	67
05539518101	30	05539520115	40	05539520314	42	05539520769	48	05539527262	140	05539527345	141	05539529322	67
05539518104	30	05539520118	40	05539520315	42	05539520770	48	05539527264	140	05539527347	141	05539529323	67
05539518105	30	05539520119	40	05539520318	42	05539520886	134	05539527268	140	05539527348	141	05539529324	67
05539518106	30	05539520120	40	05539520319	42	05539520887	134	05539527269	140	05539527349	141	05539529325	67
05539518107	30	05539520121	40	05539520320	42	05539520889	134	05539527270	140	05539527353	141	05539529326	67

PART # TO PAGE CROSS REFERENCE

PART #	PAGE	PART #	PAGE	PART #	PAGE	PART #	PAGE	PART #	PAGE	PART #	PAGE		
05539529327	67	05539553344	38	05539554474	128	05539554533	119	05539554594	120	05539554664	59	05539554723	61
05539529328	67	05539554416	114	05539554475	128	05539554534	120	05539554606	59	05539554665	58	05539554724	61
05539529329	67	05539554417	114	05539554476	128	05539554535	112	05539554607	59	05539554666	58	05539554725	61
05539529330	67	05539554418	114	05539554477	128	05539554536	112	05539554608	59	05539554667	58	05539554726	61
05539529331	67	05539554419	114	05539554478	128	05539554537	112	05539554609	59	05539554668	58	05539554727	61
05539529332	67	05539554420	114	05539554479	128	05539554538	113	05539554610	58	05539554669	58	05539554728	61
05539529333	67	05539554421	114	05539554480	128	05539554539	113	05539554611	58	05539554670	59	05539554729	61
05539529334	67	05539554422	114	05539554481	128	05539554540	113	05539554612	58	05539554671	59	05539554730	61
05539529335	67	05539554423	114	05539554482	128	05539554541	113	05539554613	58	05539554672	59	05539554731	61
05539529336	67	05539554424	114	05539554483	128	05539554542	113	05539554614	59	05539554673	59	05539554732	61
05539529337	67	05539554425	114	05539554484	128	05539554543	113	05539554615	59	05539554674	59	05539554733	61
05539529338	67	05539554426	114	05539554485	128	05539554544	113	05539554616	59	05539554675	59	05539554734	61
05539529339	67	05539554427	114	05539554486	128	05539554545	113	05539554617	59	05539554676	58	05539554735	61
05539529340	67	05539554428	114	05539554487	128	05539554546	113	05539554618	58	05539554677	58	05539554736	61
05539529341	67	05539554429	114	05539554488	128	05539554547	113	05539554619	58	05539554678	58	05539554737	61
05539529342	67	05539554430	114	05539554489	128	05539554548	113	05539554620	58	05539554679	58	05539554738	61
05539529343	67	05539554431	114	05539554490	128	05539554549	113	05539554621	58	05539554680	58	05539554739	61
05539529344	67	05539554432	114	05539554491	128	05539554550	113	05539554622	59	05539554681	59	05539554740	61
05539529345	67	05539554433	114	05539554492	128	05539554551	113	05539554623	59	05539554682	59	05539554741	61
05539529346	67	05539554434	114	05539554493	128	05539554552	113	05539554624	59	05539554683	59	05539554742	61
05539529347	67	05539554435	114	05539554494	128	05539554553	113	05539554625	59	05539554684	59	05539554743	61
05539529348	67	05539554436	113	05539554495	128	05539554554	113	05539554626	58	05539554685	59	05539554744	62
05539529349	67	05539554437	113	05539554496	128	05539554555	113	05539554627	58	05539554686	58	05539554745	62
05539529350	67	05539554438	113	05539554497	128	05539554556	113	05539554628	58	05539554687	58	05539554746	62
05539529351	75	05539554439	113	05539554498	128	05539554557	113	05539554629	58	05539554688	58	05539554747	62
05539529352	75	05539554440	113	05539554499	128	05539554558	114	05539554630	59	05539554689	58	05539554748	62
05539529353	75	05539554441	113	05539554500	128	05539554559	114	05539554631	59	05539554690	58	05539554749	62
05539529354	75	05539554442	113	05539554501	128	05539554560	114	05539554632	59	05539554691	59	05539554750	62
05539529355	75	05539554443	113	05539554502	128	05539554561	114	05539554633	59	05539554692	59	05539554751	62
05539529356	75	05539554444	113	05539554503	128	05539554562	114	05539554634	58	05539554693	59	05539554752	62
05539529357	75	05539554445	119	05539554504	128	05539554563	119	05539554635	58	05539554694	59	05539554753	62
05539529358	75	05539554446	120	05539554505	128	05539554564	120	05539554636	58	05539554695	59	05539554754	62
05539529359	75	05539554447	119	05539554506	128	05539554565	119	05539554637	58	05539554696	58	05539554755	62
05539529360	75	05539554448	120	05539554507	128	05539554566	120	05539554638	59	05539554697	58	05539554756	62
05539529361	75	05539554449	119	05539554508	128	05539554567	119	05539554639	59	05539554698	58	05539554757	62
05539529418	33	05539554450	120	05539554509	128	05539554568	120	05539554640	59	05539554699	58	05539554758	62
05539529418	48	05539554451	119	05539554510	128	05539554569	119	05539554641	59	05539554700	58	05539554759	62
05539545600	123	05539554452	120	05539554511	128	05539554570	120	05539554642	58	05539554701	59	05539554760	62
05539550000	45	05539554453	119	05539554512	128	05539554571	124	05539554643	58	05539554702	59	05539554761	63
05539550001	45	05539554454	120	05539554513	128	05539554572	124	05539554644	58	05539554703	59	05539554762	63
05539550002	45	05539554455	119	05539554514	128	05539554573	124	05539554645	58	05539554704	59	05539554763	63
05539550003	45	05539554456	120	05539554515	128	05539554574	124	05539554646	59	05539554705	59	05539554764	63
05539550004	45	05539554457	119	05539554516	128	05539554575	124	05539554647	59	05539554706	59	05539554765	63
05539550005	45	05539554458	120	05539554517	128	05539554576	124	05539554648	59	05539554707	59	05539554766	63
05539550006	45	05539554459	119	05539554518	128	05539554577	124	05539554649	59	05539554708	59	05539554767	62
05539550007	45	05539554460	120	05539554519	128	05539554578	124	05539554650	59	05539554709	59	05539554768	62
05539550008	45	05539554461	119	05539554520	128	05539554579	124	05539554651	59	05539554710	59	05539554769	62
05539550009	45	05539554462	120	05539554521	119	05539554580	124	05539554652	59	05539554711	59	05539554770	62
05539550010	45	05539554463	119	05539554522	120	05539554581	124	05539554653	59	05539554712	59	05539554771	62
05539553334	38	05539554464	120	05539554523	119	05539554582	124	05539554654	59	05539554713	59	05539554772	62
05539553335	38	05539554465	119	05539554524	120	05539554583	124	05539554655	58	05539554714	59	05539554773	62
05539553336	38	05539554466	120	05539554525	119	05539554586	120	05539554656	58	05539554715	59	05539554774	62
05539553337	38	05539554467	119	05539554526	120	05539554587	120	05539554657	58	05539554716	61	05539554775	62
05539553338	38	05539554468	120	05539554527	119	05539554588	120	05539554658	58	05539554717	61	05539554776	62
05539553339	38	05539554469	119	05539554528	120	05539554589	120	05539554659	58	05539554718	61	05539554777	62
05539553340	38	05539554470	120	05539554529	119	05539554590	120	05539554660	59	05539554719	61	05539554778	62
05539553341	38	05539554471	120	05539554530	120	05539554591	120	05539554661	59	05539554720	61	05539554779	62
05539553342	38	05539554472	119	05539554531	119	05539554592	120	05539554662	59	05539554721	61	05539554780	62
05539553343	38	05539554473	128	05539554532	120	05539554593	120	05539554663	59	05539554722	61	05539554781	62

PART # TO PAGE CROSS REFERENCE

PART #	PAGE	PART #	PAGE	PART #	PAGE	PART #	PAGE	PART #	PAGE	PART #	PAGE		
05539554782	62	05539554842	63	05539562204	141	05539562912	150	05539563863	73	05539565134	19	05539599304	48
05539554783	62	05539554843	62	05539562216	141	05539562914	150	05539563864	73	05539565136	19	05539599305	32
05539554784	63	05539554844	62	05539562221	141	05539562915	150	05539563865	73	05539565138	19	05539599305	48
05539554785	63	05539554845	62	05539562224	141	05539562922	150	05539563866	73	05539566206	15	05539599306	41
05539554786	63	05539554846	62	05539562226	141	05539562924	150	05539563877	73	05539566207	15	05539599307	41
05539554787	63	05539554847	62	05539562227	141	05539562952	136	05539563878	73	05539566208	15	05539599308	41
05539554788	63	05539554848	62	05539562230	141	05539562953	136	05539563879	73	05539567287	10	05539599309	32
05539554789	63	05539554849	62	05539562240	141	05539562966	23	05539563880	73	05539567289	10	05539599309	48
05539554790	62	05539554850	61	05539562242	141	05539562967	23	05539563881	72	05539567811	25	05539599310	36
05539554791	62	05539554851	61	05539562244	141	05539562968	23	05539563882	72	05539567812	25	05539599311	32
05539554792	62	05539554852	61	05539562246	141	05539562969	23	05539563883	72	05539567813	25	05539599311	48
05539554793	62	05539554853	61	05539562249	141	05539562970	23	05539563884	72	05539569199	143	05539599312	36
05539554794	62	05539554854	61	05539562264	141	05539563010	150	05539563885	72	05539569199	144	05539599313	41
05539554795	63	05539554855	61	05539562272	141	05539563019	23	05539563887	72	05539569412	143	05539599314	44
05539554796	63	05539554856	61	05539562277	142	05539563395	23	05539563888	72	05539569600	123	05539599315	41
05539554797	63	05539554859	124	05539562279	142	05539563438	110	05539563929	26	05539569926	39	05539599316	44
05539554798	63	05539554860	124	05539562281	142	05539563500	123	05539563930	26	05539569927	39	05539599317	32
05539554799	60	05539561102	30	05539562283	142	05539563609	35	05539563931	26	05539570019	39	05539599317	48
05539554800	60	05539561106	30	05539562285	142	05539563612	35	05539563938	132	05539570020	39	05539599318	36
05539554801	60	05539561108	30	05539562286	142	05539563624	43	05539563951	15	05539570021	39	05539599319	32
05539554802	60	05539561109	30	05539562288	142	05539563627	43	05539563952	15	05539570022	39	05539599319	48
05539554803	60	05539561110	30	05539562292	142	05539563628	43	05539563953	15	05539570054	25	05539599320	36
05539554804	60	05539561111	69	05539562294	142	05539563665	60	05539563954	15	05539570055	25	05539599321	41
05539554805	60	05539561112	69	05539562301	142	05539563666	60	05539563955	112	05539570056	25	05539599322	44
05539554806	60	05539561113	69	05539562303	142	05539563667	60	05539563956	112	05539570057	25	05539599323	41
05539554807	60	05539561114	69	05539562315	142	05539563668	60	05539563957	112	05539570058	25	05539599324	44
05539554808	60	05539561116	69	05539562316	141	05539563669	60	05539563969	23	05539570059	25	05539599423	38
05539554809	60	05539561551	9	05539562337	140	05539563670	60	05539563970	23	05539570121	80	05539599427	39
05539554810	60	05539561551	15	05539562346	140	05539563671	60	05539563971	23	05539570122	80	05539599444	38
05539554811	60	05539561553	9	05539562347	140	05539563673	60	05539563975	23	05539570123	80	05539599488	29
05539554812	60	05539561553	15	05539562348	140	05539563674	60	05539563975	112	05539570124	80	05539599489	29
05539554813	60	05539561554	9	05539562349	140	05539563675	60	05539563987	136	05539570125	80	05539599490	29
05539554814	60	05539561554	15	05539562350	140	05539563676	60	05539563988	136	05539570191	8	05539599491	29
05539554815	60	05539561555	9	05539562351	140	05539563710	135	05539563989	132	05539570192	8	05539599492	29
05539554816	60	05539561555	15	05539562363	140	05539563711	135	05539564056	26	05539570193	8	05539599493	29
05539554817	60	05539561565	9	05539562365	140	05539563741	26	05539564057	26	05539570194	8	05539599494	29
05539554818	60	05539561566	9	05539562366	140	05539563742	26	05539564058	26	05539570195	8	05539599495	29
05539554819	60	05539561567	9	05539562367	140	05539563743	26	05539564060	26	05539570196	8	05539599496	29
05539554820	60	05539561568	9	05539562370	140	05539563744	26	05539564061	26	05539570197	8	05539599497	29
05539554821	60	05539561569	9	05539562380	140	05539563745	26	05539564062	26	05539570523	69	05539599498	29
05539554822	60	05539561571	9	05539562382	140	05539563746	26	05539564063	26	05539570524	69	05539599499	29
05539554823	60	05539561573	9	05539562383	140	05539563747	26	05539564070	135	05539570525	69	05539599500	29
05539554824	60	05539561574	9	05539562395	147	05539563748	26	05539564097	110	05539570526	69	05539599501	38
05539554825	60	05539561575	9	05539562397	147	05539563779	30	05539564098	110	05539570527	69	05539599502	38
05539554826	60	05539561576	9	05539562398	147	05539563780	30	05539564477	146	05539570528	69	05539599503	38
05539554827	60	05539561577	9	05539562582	22	05539563781	39	05539564479	146	05539570539	26	05539599504	38
05539554828	60	05539561578	9	05539562582	113	05539563782	39	05539564480	145	05539570540	26	05539599505	38
05539554829	60	05539561579	9	05539562614	110	05539563784	42	05539564484	145	05539570541	26	05539599506	38
05539554830	60	05539561580	9	05539562615	108	05539563785	71	05539564486	145	05539570542	26	05539599507	38
05539554832	62	05539561581	18	05539562616	108	05539563813	75	05539564487	146	05539570544	26	05539599508	38
05539554833	62	05539561582	18	05539562617	108	05539563817	9	05539564489	143	05539573903	110	05539599509	38
05539554834	62	05539561584	16	05539562618	108	05539563819	9	05539564490	146	05539574000	123	05539599510	38
05539554835	62	05539561585	16	05539562637	127	05539563821	9	05539564492	146	05539574600	123	05539599511	38
05539554836	62	05539561586	16	05539562709	123	05539563836		05539564503	145	05539574700	123	05539599512	38
05539554837	62	05539562172	143	05539562718	114	05539563836	112	05539564511	140	05539574800	123	05539599513	38
05539554838	63	05539562175	143	05539562723	114	05539563859	73	05539564513	140	05539577700	123	05539599514	38
05539554839	63	05539562180	143	05539562839	12	05539563860	73	05539564530	145	05539579600	123	05539599515	38
05539554840	63	05539562190	143	05539562907	150	05539563861	73	05539564571	144	05539584700	123	05539599516	38
05539554841	63	05539562201	141	05539562911	150	05539563862	73	05539564599	146	05539599304	32	05539599517	38

PART # TO PAGE CROSS REFERENCE

PART #	PAGE	PART #	PAGE	PART #	PAGE	PART #	PAGE	PART #	PAGE	PART #	PAGE		
05539599518	38	08834122054	86	08834132017	85	08834137310	83	08834137515	82	08834149823	84	08834154173	103
05539599519	38	08834122055	86	08834132018	85	08834137311	83	08834137541	82	08834149824	84	08834154174	103
05539599520	38	08834122056	86	08834132020	85	08834137312	83	08834137542	82	08834149825	84	08834154175	103
05539599521	38	08834122058	86	08834132051	85	08834137313	83	08834137543	82	08834149826	84	08834154176	103
05539599522	38	08834122065	86	08834132101	83	08834137315	83	08834137544	82	08834149828	84	08834154181	104
05539599523	38	08834122066	86	08834133008	85	08834137320	83	08834137545	82	08834149834	84	08834154182	104
05539599524	38	08834123003	86	08834133009	85	08834137321	83	08834137551	82	08834149835	84	08834154183	104
05539599525	38	08834123005	86	08834133010	85	08834137322	83	08834137552	82	08834149836	84	08834154184	104
05539599526	38	08834123006	86	08834133011	85	08834137323	83	08834137553	82	08834149837	84	08834154185	56
05539599564	68	08834123009	86	08834133015	85	08834137340	83	08834137561	82	08834149838	84	08834154185	104
05539599565	68	08834123011	86	08834133016	85	08834137343	83	08834137562	82	08834149839	84	08834154186	56
05539599566	68	08834123012	86	08834133017	85	08834137370	83	08834137563	82	08834149840	84	08834154186	104
05539599567	68	08834123014	86	08834133018	85	08834137371	83	08834137571	82	08834150271	103	08834154187	56
05539599568	68	08834123016	86	08834133019	85	08834137372	83	08834137572	82	08834150273	103	08834154187	104
05539599570	68	08834123018	86	08834133020	85	08834137373	83	08834137573	82	08834150275	103	08834154190	103
05539599590	68	08834123022	86	08834133044	85	08834137374	83	08834137574	82	08834150573	104	08834154191	103
05539599591	68	08834123023	86	08834134022	85	08834137375	83	08834137575	82	08834154091	103	08834154193	103
05539599592	68	08834123025	86	08834134023	85	08834137377	83	08834137580	82	08834154092	103	08834154195	103
05539599963	64	08834123033	86	08834134024	85	08834137380	83	08834137581	82	08834154093	103	08834154197	103
05539599973	64	08834123034	86	08834134025	85	08834137381	83	08834137582	82	08834154094	103	08834161174	55
05539599974	64	08834123036	86	08834134061	85	08834137382	83	08834137583	82	08834154100	103	08834161174	121
05539599975	64	08834123038	86	08834135008	85	08834137383	83	08834137584	82	08834154101	103	08834161176	56
05539599976	64	08834123056	86	08834135015	85	08834137410	83	08834137585	82	08834154102	103	08834161625	55
05539599977	64	08834123058	86	08834135016	85	08834137411	83	08834137590	82	08834154103	103	08834161625	121
05539599978	64	08834123072	86	08834135017	85	08834137412	83	08834137591	82	08834154104	103	08834161626	55
05539599987	64	08834123073	86	08834135018	85	08834137413	83	08834137592	82	08834154109	103	08834161626	121
05539599988	64	08834123075	86	08834135019	85	08834137420	83	08834137594	82	08834154110	103	08834161627	121
05539599989	64	08834123077	86	08834135140	83	08834137421	83	08834137595	82	08834154111	103	08834161647	121
05539599990	64	08834123078	86	08834135201	85	08834137422	83	08834137633	83	08834154112	103	08834161649	121
05539599991	64	08834123095	86	08834135202	85	08834137450	83	08834138001	84	08834154118	103	08834161651	121
05539599992	64	08834125001	87	08834135203	85	08834137451	83	08834138004	84	08834154119	103	08834161654	121
07660724376	153	08834125003	87	08834135204	85	08834137456	83	08834138118	126	08834154120	103	08834162764	56
07660789275	10	08834125017	87	08834135230	85	08834137460	83	08834138119	126	08834154121	103	08834163001	56
07958787451	156	08834125018	87	08834135339	83	08834137470	82	08834138120	126	08834154122	103	08834163002	56
07958787452	156	08834125027	87	08834135341	83	08834137471	82	08834138122	126	08834154127	103	08834163559	120
07958787453	156	08834126006	127	08834137001	87	08834137472	82	08834138123	126	08834154128	103	08834163948	55
07958787454	156	08834126028	127	08834137003	87	08834137473	82	08834138125	126	08834154129	103	08834163948	121
07958787455	156	08834126030	127	08834137004	87	08834137474	82	08834138126	126	08834154130	103	08834163949	55
07958787456	156	08834130643	83	08834137005	87	08834137475	82	08834138129	126	08834154136	103	08834163949	121
07958787457	156	08834130644	83	08834137010	87	08834137480	82	08834138130	126	08834154137	103	08834163987	120
07958787458	156	08834131001	85	08834137012	87	08834137481	82	08834144457	126	08834154138	103	08834163996	55
07958787459	156	08834131002	85	08834137100	83	08834137482	82	08834144458	126	08834154139	103	08834163996	121
07958787461	156	08834131003	85	08834137101	83	08834137483	82	08834144459	126	08834154140	103	08834163997	55
07958787462	156	08834131008	85	08834137102	83	08834137484	82	08834144460	126	08834154145	103	08834163997	121
07958787463	156	08834131009	85	08834137104	83	08834137485	82	08834144461	126	08834154146	103	08834163998	55
07958787464	157	08834131010	85	08834137105	83	08834137491	82	08834144463	85	08834154147	103	08834163998	121
07958787465	157	08834131011	85	08834137114	83	08834137492	82	08834149802	84	08834154148	103	08834164001	55
07958787466	157	08834131012	85	08834137141	83	08834137493	82	08834149803	84	08834154149	103	08834164002	55
07958787467	157	08834131013	85	08834137142	83	08834137495	82	08834149804	84	08834154154	103	08834164002	121
08834120169	86	08834131027	85	08834137160	83	08834137501	82	08834149806	84	08834154155	103	08834164003	55
08834120170	86	08834131259	83	08834137161	83	08834137502	82	08834149807	84	08834154156	103	08834164003	121
08834120172	86	08834131493	84	08834137162	83	08834137503	82	08834149810	84	08834154157	103	08834164004	55
08834120458	126	08834131536	83	08834137183	83	08834137504	82	08834149811	84	08834154158	103	08834164004	121
08834121115	126	08834131921	126	08834137252	83	08834137505	82	08834149812	84	08834154163	103	08834164005	55
08834122013	86	08834132001	85	08834137253	83	08834137508	82	08834149816	84	08834154164	103	08834164005	121
08834122024	86	08834132002	85	08834137260	83	08834137511	82	08834149817	84	08834154165	103	08834164006	55
08834122034	86	08834132003	85	08834137261	83	08834137512	82	08834149818	84	08834154166	103	08834164006	121
08834122035	86	08834132015	85	08834137262	83	08834137513	82	08834149821	84	08834154167	103	08834164008	55
08834122037	86	08834132016	85	08834137263	83	08834137514	82	08834149822	84	08834154172	103	08834164009	55

PART # TO PAGE CROSS REFERENCE

PART #	PAGE	PART #	PAGE	PART #	PAGE	PART #	PAGE	PART #	PAGE	PART #	PAGE	PART #	PAGE
08834164011	55	08834164922	111	08834171105	47	08834171182	47	08834180131	96	08834180326	91	08834180712	92
08834164012	55	08834164922	121	08834171106	47	08834171184	47	08834180133	96	08834180327	91	08834180789	91
08834164013	55	08834164949	55	08834171107	47	08834171188	47	08834180137	91	08834180328	91	08834180791	91
08834164015	55	08834164949	111	08834171108	47	08834171189	47	08834180138	91	08834180329	91	08834180873	96
08834164016	55	08834164949	121	08834171109	47	08834171190	47	08834180140	91	08834180331	91	08834180886	94
08834164017	56	08834166280	121	08834171110	47	08834171191	47	08834180145	96	08834180333	91	08834180907	91
08834164018	56	08834166281	121	08834171114	47	08834171192	47	08834180156	91	08834180335	91	08834180918	96
08834164019	56	08834166282	121	08834171115	47	08834171193	47	08834180157	91	08834180338	91	08834180919	91
08834164020	56	08834166284	121	08834171116	47	08834171194	47	08834180159	91	08834180350	91	08834181061	92
08834164021	56	08834166285	121	08834171117	47	08834171195	47	08834180194	91	08834180351	91	08834181080	91
08834164026	56	08834166286	121	08834171118	47	08834171196	47	08834180195	91	08834180358	91	08834181195	91
08834164028	56	08834166292	121	08834171119	47	08834171197	47	08834180197	91	08834180364	91	08834181202	95
08834164036	55	08834166293	121	08834171120	47	08834171198	47	08834180211	91	08834180381	91	08834181203	95
08834164036	111	08834166294	121	08834171121	47	08834171199	47	08834180212	91	08834180382	91	08834181204	95
08834164036	121	08834166295	121	08834171122	47	08834174096	48	08834180213	91	08834180383	91	08834181205	95
08834164037	55	08834166296	121	08834171123	47	08834174097	48	08834180214	91	08834180392	91	08834181206	95
08834164037	121	08834166297	121	08834171124	47	08834174098	48	08834180215	91	08834180393	91	08834181207	95
08834164038	55	08834166303	121	08834171129	47	08834174099	48	08834180216	91	08834180394	91	08834181208	95
08834164041	56	08834166304	121	08834171130	47	08834174100	48	08834180217	91	08834180395	91	08834181209	95
08834164055	56	08834166305	121	08834171131	47	08834174101	48	08834180218	91	08834180400	91	08834181210	95
08834164064	120	08834166308	121	08834171132	47	08834174102	48	08834180220	91	08834180401	91	08834181211	95
08834164065	120	08834166309	121	08834171133	47	08834180005	91	08834180228	91	08834180402	91	08834181215	95
08834164113	55	08834166310	121	08834171134	47	08834180023	91	08834180229	91	08834180403	91	08834181216	95
08834164113	121	08834166314	121	08834171135	47	08834180024	91	08834180230	91	08834180456	91	08834181217	95
08834164135	55	08834166315	121	08834171136	47	08834180025	91	08834180231	91	08834180459	91	08834181218	95
08834164135	121	08834166316	121	08834171137	47	08834180026	91	08834180232	91	08834180461	91	08834181220	95
08834164146	55	08834166332	121	08834171138	47	08834180027	91	08834180233	91	08834180469	91	08834181221	95
08834164146	121	08834166333	121	08834171139	47	08834180028	91	08834180234	91	08834180474	91	08834181222	95
08834164198	55	08834166368	121	08834171144	47	08834180030	91	08834180235	91	08834180476	91	08834181223	95
08834164198	121	08834166369	121	08834171145	47	08834180032	91	08834180236	91	08834180477	91	08834181230	94
08834164206	55	08834166391	121	08834171146	47	08834180042	91	08834180238	91	08834180478	91	08834181240	94
08834164244	120	08834166392	121	08834171147	47	08834180043	91	08834180240	91	08834180479	91	08834181286	94
08834164245	120	08834166393	121	08834171148	47	08834180045	91	08834180250	91	08834180480	91	08834181297	91
08834164252	120	08834166394	121	08834171149	47	08834180060	91	08834180251	91	08834180482	91	08834181309	92
08834164255	120	08834166395	121	08834171150	47	08834180061	91	08834180252	91	08834180487	91	08834181444	94
08834164303	55	08834166396	121	08834171151	47	08834180062	91	08834180253	91	08834180488	91	08834181543	91
08834164622	55	08834166397	121	08834171152	47	08834180063	91	08834180270	91	08834180489	91	08834181708	94
08834164622	121	08834166398	121	08834171153	47	08834180064	91	08834180275	91	08834180490	91	08834181709	94
08834164624	55	08834166399	121	08834171154	47	08834180065	91	08834180286	91	08834180494	91	08834181714	94
08834164624	121	08834166400	121	08834171159	47	08834180066	91	08834180287	91	08834180496	91	08834181715	94
08834164626	55	08834166401	121	08834171160	47	08834180068	91	08834180288	91	08834180497	91	08834181717	94
08834164626	121	08834166402	121	08834171161	47	08834180069	91	08834180289	91	08834180498	91	08834181724	94
08834164640	55	08834166403	121	08834171162	47	08834180070	91	08834180290	91	08834180499	91	08834181727	94
08834164640	121	08834166404	121	08834171163	47	08834180074	96	08834180291	91	08834180506	91	08834181728	94
08834164641	55	08834166405	121	08834171164	47	08834180079	91	08834180292	91	08834180507	91	08834181734	94
08834164641	111	08834166406	121	08834171165	47	08834180080	91	08834180293	91	08834180523	91	08834181735	94
08834164641	121	08834166417	121	08834171166	47	08834180081	91	08834180295	91	08834180527	91	08834181737	94
08834164643	55	08834168025	114	08834171167	47	08834180082	91	08834180297	91	08834180580	91	08834181743	94
08834164643	111	08834168032	114	08834171168	47	08834180083	91	08834180304	91	08834180583	91	08834181744	94
08834164643	121	08834168539	28	08834171169	47	08834180084	91	08834180305	91	08834180584	91	08834181745	94
08834164644	55	08834168967	114	08834171173	47	08834180085	91	08834180306	91	08834180585	91	08834181746	94
08834164644	111	08834168984	114	08834171174	47	08834180089	91	08834180307	91	08834180587	91	08834181747	94
08834164644	121	08834169025	92	08834171175	47	08834180096	96	08834180308	91	08834180589	91	08834181749	94
08834164651	55	08834169032	92	08834171176	47	08834180100	91	08834180309	91	08834180591	91	08834181750	94
08834164651	121	08834171100	47	08834171177	47	08834180101	91	08834180310	91	08834180592	91	08834181754	94
08834164655	55	08834171101	47	08834171178	47	08834180102	91	08834180311	91	08834180603	91	08834181755	94
08834164655	121	08834171102	47	08834171179	47	08834180116	96	08834180312	91	08834180606	91	08834181757	94
08834164922	28	08834171103	47	08834171180	47	08834180122	96	08834180314	91	08834180653	91	08834181776	94
08834164922	55	08834171104	47	08834171181	47	08834180129	96	08834180316	91	08834180710	92	08834181777	94

PART # TO PAGE CROSS REFERENCE

PART #	PAGE	PART #	PAGE	PART #	PAGE	PART #	PAGE	PART #	PAGE	PART #	PAGE	PART #	PAGE
08834181781	94	08834184129	99	08834186894	96	08834196522	89	61463616470	151	61463624443	154	66252830585	15
08834181807	94	08834184135	99	08834186895	96	08834196525	89	61463616471	151	61463624448	154	66252830879	8
08834181808	94	08834184142	99	08834187134	90	08834196530	89	61463616472	151	61463624449	154	66252832324	15
08834181809	94	08834184145	101	08834189131	92	08834196531	89	61463616473	151	61463624451	154	66252832395	8
08834181811	94	08834184151	101	08834189233	92	08834196533	89	61463616474	151	61463624452	154	66252832396	8
08834181820	94	08834184159	101	08834189904	95	08834196545	89	61463616475	151	61463624466	154	66252832507	8
08834181875	94	08834184194	99	08834195825	89	08834196554	89	61463616476	151	61463624470	154	66252832508	8
08834181878	94	08834184195	99	08834195857	89	08834196555	89	61463617520	151	61463624471	154	66252832509	8
08834181879	94	08834184206	99	08834196030	88	08834196572	89	61463617521	151	61463624472	154	66252833457	10
08834182043	96	08834184221	90	08834196067	89	08834196574	89	61463620242	152	61463624474	154	66252833458	10
08834182044	96	08834184224	101	08834196069	89	08834196591	89	61463621421	152	61463624475	154	66252836280	9
08834182057	98	08834184236	101	08834196070	89	08834196595	89	61463622646	152	61463624479	154	66252836280	16
08834182132	99	08834184258	99	08834196071	89	08834196596	89	61463622649	152	61463624481	154	66252836281	16
08834182135	99	08834184270	101	08834196072	89	08834196620	89	61463622651	152	61463624482	154	66252836281	16
08834182140	99	08834184279	101	08834196073	89	08834196665	89	61463622654	152	61463624484	154	66252836282	9
08834182148	99	08834184285	99	08834196074	89	08834196676	89	61463622655	152	61463624485	154	66252836282	16
08834182152	98	08834184291	101	08834196075	89	08834196703	89	61463622656	152	61463624488	154	66252837844	19
08834182156	99	08834184302	101	08834196090	89	08834196729	89	61463622657	152	61463624489	154	66252837845	19
08834182157	99	08834184334	98	08834196091	89	08834196756	89	61463622664	152	61463624491	154	66252837846	19
08834182184	99	08834184336	98	08834196110	89	08834196809	89	61463622926	152	61463624495	154	66252837847	19
08834182196	99	08834184344	101	08834196151	89	08834196827	89	61463624374	153	61463624496	154	66252842466	6
08834182197	96	08834184346	101	08834196152	89	08834196904	88	61463624375	153	61463624497	154	66252842467	8
08834182199	96	08834184370	99	08834196159	89	08834196906	88	61463624377	153	61463624501	154	66252842468	8
08834182359	92	08834184377	99	08834196161	89	08834196907	88	61463624378	153	61463624503	154	66252842743	19
08834182505	91	08834184394	98	08834196164	89	08834196908	88	61463624380	153	61463624504	154	66252844347	9
08834182535	96	08834184397	98	08834196165	89	08834196910	88	61463624381	153	61463624505	154	66252844348	9
08834182537	96	08834184402	99	08834196166	89	08834196911	88	61463624382	153	61463624511	154	66252844349	8
08834182717	96	08834184431	101	08834196168	89	08834196912	88	61463624384	153	61463624516	154	66252844349	9
08834182807	91	08834184444	101	08834196173	89	08834196913	88	61463624385	153	61463624517	154	66252844350	8
08834183162	97	08834184463	98	08834196175	89	08834196916	88	61463624388	153	61463624518	154	66252844351	9
08834183163	97	08834184465	99	08834196176	89	08834196917	88	61463624389	153	61463624525	154	66252844352	9
08834183164	97	08834184487	98	08834196177	89	08834196918	88	61463624390	153	61463624526	154	66252844353	8
08834183164	122	08834184498	101	08834196179	89	08834196921	88	61463624391	153	61463624528	154	66252844354	6
08834183168	91	08834184655	101	08834196184	89	08834196922	88	61463624392	153	61463624530	154	66252844356	6
08834183274	92	08834184805	99	08834196188	89	08834196923	88	61463624394	153	61463624531	154	66252844357	6
08834183313	94	08834184818	101	08834196189	89	08834196926	88	61463624395	153	61463624539	154	66252844358	6
08834183448	95	08834184826	98	08834196195	89	08834196927	88	61463624396	153	61463624543	154	66252844359	6
08834183460	95	08834184828	98	08834196197	89	08834196928	88	61463624397	153	61463624544	154	66252844360	6
08834183799	95	08834184882	98	08834196198	89	08834196931	88	61463624399	153	61463624549	154	66252844361	6
08834184000	101	08834184943	99	08834196199	89	08834196944	88	61463624402	153	61463624550	154	66252844362	6
08834184019	101	08834184994	98	08834196212	89	08834197063	89	61463624404	153	61463624553	154	66252844363	8
08834184023	101	08834185078	101	08834196215	89	08834197140	89	61463624405	153	61463624560	154	66252844364	8
08834184041	101	08834185155	101	08834196219	89	08834197158	89	61463624406	153	61463624562	154	66252844365	13
08834184042	101	08834185164	99	08834196228	89	08834197688	89	61463624407	153	61463624564	154	66252844366	13
08834184055	101	08834185519	99	08834196249	89	08834197806	89	61463624408	153	61463624566	154	66252844367	9
08834184065	101	08834185578	99	08834196250	89	08834197869	89	61463624410	154	61463624567	154	66252844367	15
08834184066	101	08834185678	122	08834196253	89	08834197903	89	61463624412	154	61463624569	154	66252844368	9
08834184074	99	08834185923	122	08834196256	89	08834197968	89	61463624413	154	61463624578	154	66252844368	15
08834184076	101	08834185924	122	08834196261	89	08834485928	122	61463624414	154	61463624583	154	66252844369	7
08834184077	101	08834185925	122	08834196262	89	61463616457	151	61463624415	154	61463624585	154	66252844369	15
08834184079	101	08834185926	122	08834196263	89	61463616458	151	61463624416	154	61463624587	154	66252844370	7
08834184082	101	08834185927	122	08834196264	89	61463616459	151	61463624418	154	61463624588	154	66252844370	15
08834184084	101	08834185929	122	08834196265	89	61463616460	151	61463624419	154	61463624592	154	66252844371	7
08834184085	101	08834185931	122	08834196268	89	61463616462	151	61463624420	154	63642506160	45	66252844371	15
08834184116	99	08834185932	122	08834196270	89	61463616463	151	61463624422	154	66252830561	8	66252844372	18
08834184119	99	08834185933	122	08834196343	89	61463616464	151	61463624423	154	66252830562	8	66252844373	8
08834184124	98	08834185934	122	08834196445	89	61463616465	151	61463624424	154	66252830584	9	66252844374	7
08834184125	98	08834186035	101	08834196452	89	61463616466	151	61463624425	154	66252830584	15	66252844375	9
08834184128	99	08834186893	96	08834196515	89	61463616467	151	61463624437	154	66252830585	9	66252844376	8

PART # TO PAGE CROSS REFERENCE

PART #	PAGE	PART #	PAGE	PART #	PAGE	PART #	PAGE	PART #	PAGE	PART #	PAGE		
66252844377	6	66261021758	109	66261194496	99	66623318824	51	66623362947	40	69957399626	52	69957399684	52
66252844378	6	66261021761	109	66261194502	99	66623318825	51	66623362948	40	69957399627	52	69957399685	52
66252844379	8	66261023909	109	66261194504	99	66623318826	51	66623362949	40	69957399628	52	69957399686	52
66252844380	19	66261023910	109	66261194508	99	66623318830	51	66623362950	40	69957399629	52	69957399687	52
66252844381	7	66261023940	109	66261194511	99	66623318831	51	66623362951	40	69957399630	52	69957399688	52
66252844497	160	66261023942	109	66261194513	99	66623318833	51	66623362952	40	69957399631	52	69957399689	52
66252844498	160	66261040470	90	66261194516	99	66623318834	51	66623362953	40	69957399632	52	69957399690	52
66252844499	161	66261041270	90	66261194520	98	66623318836	51	66623362954	40	69957399633	52	69957399691	52
66252844500	160	66261042229	92	66261194528	98	66623318839	51	66623362955	40	69957399634	52	69957399692	52
66252844501	160	66261042229	95	66261194531	98	66623318841	51	66623362956	40	69957399635	52	69957399693	52
66252844502	162	66261046936	95	66261194549	99	66623318842	51	66623362957	40	69957399636	52	69957399694	52
66252844503	162	66261054013	55	66261194551	99	66623318843	51	66623362958	40	69957399637	52	69957399695	52
66252844504	162	66261054014	55	66261194552	98	66623318846	51	66623362959	40	69957399638	52	69957399696	52
66252844505	162	66261054182	118	66261194554	98	66623318847	51	66623362960	40	69957399639	52	69957399697	52
66252844506	162	66261054183	118	66261194555	98	66623326212	25	66623365788	40	69957399640	52	69957399698	52
66252844507	162	66261054184	118	66261194556	98	66623326217	25	66623365789	40	69957399641	52	69957399699	52
66252844508	161	66261054185	118	66261194557	98	66623326218	25	66623366071	43	69957399642	52	69957399700	52
66252844509	161	66261054186	118	66261194558	98	66623326219	25	66623366073	43	69957399643	52	69957399701	52
66252844510	161	66261054187	118	66261195051	100	66623326220	25	66623366074	43	69957399644	52	69957399702	52
66252844511	161	66261054192	118	66261195054	100	66623326221	25	66623366075	43	69957399645	52	69957399703	52
66252844512	163	66261054193	118	66261195055	100	66623326222	25	66623366077	43	69957399646	52	69957399704	52
66252844513	163	66261054194	118	66261195056	100	66623326223	25	66623369778	43	69957399647	52	69957399705	53
66252844514	163	66261054195	118	66261195057	100	66623326233	25	69957300001	90	69957399648	52	69957399706	53
66252844515	163	66261054196	118	66261195058	100	66623329280	110	69957348198	32	69957399649	52	69957399707	53
66252844516	163	66261054197	118	66261195059	100	66623329282	110	69957348200	32	69957399650	52	69957399708	53
66252844537	15	66261054198	118	66261195367	100	66623334493	68	69957348201	32	69957399651	52	69957399709	53
66253051696	143	66261066726	92	66261195368	100	66623334494	68	69957348202	32	69957399652	52	69957399710	53
66253051698	143	66261068838	26	66623311870	71	66623334495	68	69957348203	32	69957399653	52	69957399711	53
66253051967	143	66261068846	26	66623311871	71	66623335601	68	69957348204	32	69957399654	52	69957399712	53
66253051969	143	66261068848	26	66623311873	71	66623345609	68	69957348206	32	69957399655	52	69957399713	53
66253052850	143	66261080383	127	66623311874	71	66623345611	68	69957348223	32	69957399656	52	69957399714	53
66253054746	143	66261080384	127	66623311875	71	66623345612	68	69957352447	32	69957399657	52	69957399715	53
66253054748	143	66261080514	127	66623311876	71	66623362921	31	69957399202	126	69957399658	52	69957399716	53
66253054767	143	66261080527	127	66623311877	71	66623362922	31	69957399601	52	69957399659	52	69957399717	53
66253054769	143	66261080528	127	66623311878	71	66623362923	31	69957399602	52	69957399660	52	69957399718	53
66253054775	141	66261080529	127	66623311879	71	66623362924	31	69957399603	52	69957399661	52	69957399719	53
66253059536	148	66261080530	127	66623318718	51	66623362925	31	69957399604	52	69957399662	52	69957399720	53
66253060236	148	66261080531	127	66623318719	51	66623362926	31	69957399605	52	69957399663	52	69957399721	53
66253060288	149	66261080532	127	66623318720	51	66623362927	31	69957399606	52	69957399664	52	69957399722	53
66253370022	162	66261086969	92	66623318721	51	66623362928	31	69957399607	52	69957399665	52	69957399723	53
66253383004	148	66261185977	95	66623318722	51	66623362929	31	69957399608	52	69957399666	52	69957399724	53
66253383005	148	66261189992	126	66623318724	51	66623362930	31	69957399609	52	69957399667	52	69957399725	53
66253383006	148	66261189993	126	66623318725	51	66623362931	32	69957399610	52	69957399668	52	69957399726	53
66253383007	148	66261194384	90	66623318731	51	66623362932	32	69957399611	52	69957399669	52	69957399727	53
66253383008	148	66261194392	90	66623318733	51	66623362933	32	69957399612	52	69957399670	52	69957399728	53
66253383009	148	66261194393	90	66623318734	51	66623362934	32	69957399613	52	69957399671	52	69957399729	53
66253383010	148	66261194394	90	66623318735	51	66623362935	32	69957399614	52	69957399672	52	69957399730	53
66253383011	148	66261194395	90	66623318736	51	66623362936	32	69957399615	52	69957399673	52	69957399731	53
66253383012	148	66261194396	90	66623318737	51	66623362937	32	69957399616	52	69957399674	52	69957399732	53
66253383015	149	66261194397	90	66623318738	51	66623362938	32	69957399617	52	69957399675	52	69957399733	53
66253383016	149	66261194398	90	66623318740	51	66623362939	32	69957399618	52	69957399676	52	69957399734	53
66253383017	149	66261194399	90	66623318741	51	66623362940	32	69957399619	52	69957399677	52	69957399735	53
66253383018	149	66261194481	93	66623318742	51	66623362941	40	69957399620	52	69957399678	52	69957399736	53
66253383019	149	66261194484	93	66623318743	51	66623362942	40	69957399621	52	69957399679	52	69957399737	53
66253383021	149	66261194490	93	66623318744	51	66623362943	40	69957399622	52	69957399680	52	69957399738	53
66261012798	90	66261194491	93	66623318745	51	66623362944	40	69957399623	52	69957399681	52	69957399739	53
66261021750	109	66261194492	93	66623318746	51	66623362945	40	69957399624	52	69957399682	52	69957399740	53
66261021754	109	66261194495	93	66623318747	51	66623362946	40	69957399625	52	69957399683	52	69957399741	53

PART # TO PAGE CROSS REFERENCE

PART #	PAGE	PART #	PAGE	PART #	PAGE	PART #	PAGE	PART #	PAGE	PART #	PAGE	PART #	PAGE
69957399742	53	69957399781	53	77696000116	21	77696002076	27	77696088242	54	77696088281	54	77696090109	27
69957399743	53	69957399782	53	77696000117	21	77696002077	27	77696088243	54	77696088282	54	77696090110	27
69957399744	53	69957399783	53	77696000118	21	77696002078	27	77696088244	54	77696088283	54	77696090111	27
69957399745	53	69957399784	53	77696000119	21	77696002079	27	77696088245	54	77696088284	54	77696090112	27
69957399746	53	69957399785	53	77696000120	21	77696002080	27	77696088246	54	77696088285	54	77696090113	27
69957399747	53	69957399786	53	77696000121	21	77696002081	27	77696088247	54	77696088286	54	77696090114	27
69957399748	53	69957399787	53	77696000122	21	77696002082	27	77696088248	54	77696088287	54	77696090115	27
69957399749	53	69957399788	53	77696000123	21	77696002083	27	77696088249	54	77696088288	54	77696090116	27
69957399750	53	69957399789	53	77696000124	21	77696002084	27	77696088250	54	77696088289	54	77696 090117	27
69957399751	53	69957399790	53	77696000125	22	77696002086	27	77696088251	54	77696088290	54	77696090118	27
69957399752	53	69957399791	53	77696000126	22	77696002088	27	77696088252	54	77696089001	92	77696090119	28
69957399753	53	69957399792	53	77696000127	22	77696002092	27	77696088253	54	77696089002	92	77696090120	28
69957399754	53	69957399793	53	77696000128	22	77696002093	27	77696088254	54	77696089003	92	77696090121	28
69957399755	53	69957399794	53	77696000129	22	77696009801	22	77696088255	54	77696089004	92	77696090122	28
69957399756	53	69957399795	53	77696000130	22	77696009802	22	77696088256	54	77696089005	92	77696090123	28
69957399757	53	69957399796	53	77696000131	22	77696009804	22	77696088257	54	77696089006	92	77696090124	28
69957399758	53	69957399797	53	77696000132	22	77696009805	22	77696088258	54	77696089007	92	77696090125	28
69957399759	53	69957399798	53	77696000133	22	77696009806	22	77696088259	54	77696089008	92	77696090126	28
69957399760	53	69957399799	53	77696000134	22	77696009807	22	77696088260	54	77696089009	92	77696090127	28
69957399761	53	69957399800	53	77696000135	22	77696009808	22	77696088261	54	77696089010	94	77696090128	28
69957399762	53	69957399801	53	77696000136	22	77696009809	22	77696088262	54	77696089011	94	77696090129	28
69957399763	53	69957399802	53	77696000137	22	77696009810	22	77696088263	54	77696089012	94	77696090130	28
69957399764	53	69957399803	53	77696000138	22	77696009812	22	77696088264	54	77696089013	94	77696090131	28
69957399765	53	69957399804	53	77696000139	22	77696009815	22	77696088265	54	77696089014	94	77696090132	28
69957399766	53	77696000101	21	77696000140	22	77696009816	22	77696088266	54	77696089015	94	77696090133	28
69957399767	53	77696000102	21	77696000141	22	77696009817	22	77696088267	54	77696090095	27	77696090134	28
69957399768	53	77696000103	21	77696000142	22	77696039321	110	77696088268	54	77696090096	27	77696090135	28
69957399769	53	77696000104	21	77696000143	22	77696061650	111	77696088269	54	77696090097	27	77696090136	28
69957399770	53	77696000105	21	77696002060	27	77696088231	54	77696088270	54	77696090098	27	77696090137	28
69957399771	53	77696000106	21	77696002062	27	77696088232	54	77696088271	54	77696090099	27	77696090138	28
69957399772	53	77696000107	21	77696002063	27	77696088233	54	77696088272	54	77696090100	27		
69957399773	53	77696000108	21	77696002064	27	77696088234	54	77696088273	54	77696090101	27		
69957399774	53	77696000109	21	77696002065	27	77696088235	54	77696088274	54	77696090102	27		
69957399775	53	77696000110	21	77696002068	27	77696088236	54	77696088275	54	77696090103	27		
69957399776	53	77696000111	21	77696002070	27	77696088237	54	77696088276	54	77696090104	27		
69957399777	53	77696000112	21	77696002071	27	77696088238	54	77696088277	54	77696090105	27		
69957399778	53	77696000113	21	77696002072	27	77696088239	54	77696088278	54	77696090106	27		
69957399779	53	77696000114	21	77696002073	27	77696088240	54	77696088279	54	77696090107	27		
69957399780	53	77696000115	21	77696002075	27	77696088241	54	77696088280	54	77696090108	27		

safety symbols



FACE PROTECTION

Always wear government-approved face and eye protection when using abrasive products.



SAFETY GLOVES

Grinding applications are conducted in harsh environments. The use of proper fitting gloves is recommended.



DUST PROTECTION

Exposure to dust generated from workpiece and/or abrasive materials can result in lung damage and/or other physical injury.

Use dust capture or local exhaust as stated in the MSDS. Wear government-approved respiratory protection and eye and skin protection.

Failure to follow this warning can result in serious lung damage and/or physical injury.

This is a general dust warning and does not cover specific situations. For more information, refer to the MSDS dust warning provided with your products, and workpiece.

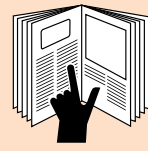

SAFETY GUIDES, MSDS & WHEEL WARNING MESSAGES

Before using any abrasive materials, READ:

- The Safety Guides
- Wheel Warning Messages and
- Material Safety Data Sheets (MSDS)

Carborundum provides information pertaining to the safe use of all products. Please take the time to read it carefully. Contact suppliers of the workpiece and abrasive materials for copies of the MSDS if one is not readily available. Carborundum abrasives MSDS can be obtained on-line at www.carborundumabrasives.com



HEARING PROTECTION

Use of abrasive products might create elevated sound levels. Hearing protection must be worn where required.

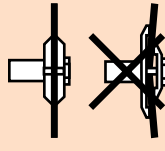

FLANGES

When mounting most grinding wheels, use flanges of equal diameter and bearing surface. For exceptions, see ANSI B7.1.

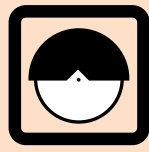

WHEEL GUARD

Always use the wheel guard as supplied by the machine manufacturer, in the proper position.



SPEEDS

Check machine spindle speed and speed listed on machine against safe maximum operating speed marked on the grinding wheel. Do not overspeed the wheel.



WARNING

This warning icon appears on our products and packaging. It is intended to draw your attention to the specific safety warning practices outlined after it.

SAFETY ON THE WEB

As part of Saint-Gobain Abrasives' ongoing commitment to safety, each month a new safety article is published on the Carborundum website. Topics include proper abrasive storage, equipment maintenance, proper wheel mounting, using blotters, ring testing a grinding wheel, wheel dressing and much more.

Visit the Carborundum website at www.carborundumindustrial.com and check the "News" section for the newest article. Or click on "Safety" to review our archived safety articles.

For more information on product safety, ask your Carborundum Abrasives distributor for these publications:

- "Play it Safe at the Wheel" pamphlet CA8900, and "Safety, It's the Smart Thing to Do" DVD
- ANSI Standard B7.1 Safety Requirements for the Use, Care and Protection of Abrasive Wheels
- ANSI Standard B7.7 Safety Requirements for Abrading Materials with Coated Abrasive Systems

For additional safety information, visit our website at www.carborundumindustrial.com



safetytips

DEPRESSED CENTER, CUT-OFF, AND SNAGGING WHEELS

Do's

- Check all wheels for cracks or damage before use
- Check machine speed against established safe operating speed marked on the wheel
- Always use the guard furnished with machine
- Run wheel in a protected area for one minute at operating speed before grinding

Don'ts

- Don't use wheels that have been dropped or otherwise damaged
- Don't use heavy side pressure on any thin Type O1 cut-off wheel or Type 27/42 thin depressed center wheel
- Never use a grinding wheel with a rated speed less than that of the grinder

PROPER GRINDING WHEEL OPERATING SPEEDS AND SAFETY!

As abrasive wheel producers have known for many years, most grinding wheel breakages and injuries are caused by one major oversight. That oversight is operating a grinding wheel in an over-speed condition. A grinding wheel should never be operated at speeds greater than the wheel's rated speed.

- Never mount grinding wheels on sanders (Pistol Grip Air Sanders)
- Never mount grinding wheels directly on electric motors
- Never mount grinding wheels on the wrong size machine for the grinding wheel
- Always properly maintain your machine: especially governors on pneumatic machines and linkage on floorstand machines
- Never use the incorrect air, hydraulic or electric power supply
- Never use the improper speed setting on a machine

TOOLROOM WHEELS

Do's

- Check all wheels for cracks or damage before use
- Always use a safety guard and ensure work rest is properly adjusted on a bench grinder
- Always handle and store wheels in a careful manner
- Check mounting flanges for equal and correct diameter and use blotters when supplied
- Check machine speed against established safe operating speed marked on wheel

Don'ts

- Don't use a cracked wheel or one that has been dropped or damaged
- Don't exceed recommended operating speeds
- Don't tighten the mounting nut excessively
- Don't jam work into the wheel
- Do not sand wood, plastic or any other non-metallic material on bench and pedestal grinders

A DEADLY EQUATION

**PISTOL GRIP AIR SANDER
+ GRINDING WHEEL
= CERTAIN INJURY!**

- Never use a high-speed air sander as a portable grinder
- Use only sanding discs specifically designed for sanders
- Because the speed of these sanders far exceeds the maximum rated speeds for grinding wheels, a potentially lethal wheel breakage might occur



PISTOL GRIP AIR SANDER



IT IS THE USER'S RESPONSIBILITY TO REFER TO AND COMPLY WITH ANSI B7.1 AND B7.7 SAFETY STANDARDS



CALL YOUR LOCAL DISTRIBUTOR FOR OUR SAFETY DVD:

“SAFETY, IT'S THE SMART THING TO DO!”

WHAT ARE THE MAJOR CAUSES OF GRINDING WHEEL BREAKAGES?

A grinding wheel is a safe tool when used properly. All grinding wheels are tested in accordance with ANSI B7.1 before Saint-Gobain ships them. However, after the grinding wheels are shipped they might be subjected to any number of abuses and misuses. Listed here are some of the major causes of grinding wheel breakages.

- Using a grinding wheel damaged during transportation, storage or as a result of careless or improper handling. Inspect all grinding wheels before mounting them on a machine. NEVER MOUNT A DAMAGED GRINDING WHEEL.
- Selecting the wrong grinding wheel for the job. DON'T GRIND MATERIAL FOR WHICH THE WHEEL IS NOT DESIGNED.
- Incorrect machine. NEVER MOUNT A GRINDING WHEEL ON A MACHINE NOT DESIGNED AND GUARDED FOR THAT GRINDING WHEEL.
- Machine speed higher than the grinding wheel speed. NEVER OVER-SPEED A GRINDING WHEEL.
- Poor machine maintenance. FAILURE TO PROPERLY MAINTAIN A GRINDING MACHINE CAN CAUSE GRINDING WHEEL BREAKAGES RESULTING IN SERIOUS INJURY OR DEATH.
- The improper mounting of grinding wheels. See ANSI B7.1 and literature provided for proper mounting procedures.
- Operator carelessness. ALL GRINDING WHEELS CAN BE BROKEN IF NOT USED PROPERLY.
- Lack of knowledge or training. IF YOU DO NOT KNOW HOW TO USE A GRINDING WHEEL OR THE GRINDER, GET HELP!
- Poor wheel balance caused by the failure to turn off coolant before stopping the grinding wheel. Always spin coolant out of a grinding wheel before shutting the operation down.
- Jamming the work into the grinding wheel.
- Force grinding, so that the motor slows noticeably or the work gets hot.
- Grinding on the wrong surface of a grinding wheel, i.e. grinding on the side of a Type 1 straight grinding wheel.

For additional information on this topic or any other grinding wheel safety information, please review ANSI, OSHA and literature provided by the grinding wheel and machine manufacturer. You may also contact the Saint-Gobain Product Safety Department at Tel. (508) 795-2317 or Fax. (508) 795-5120 for additional product safety information. See "Safety" section on www.carborundumabrasives.com.



STARTING A GRINDING WHEEL

ANSI'S PROCEDURE FOR STARTING AN ABRASIVE WHEEL

In the past several years we have heard of wheel breakages and accidents involving abrasive wheels breaking on start-up. This article is designed to remind users of the proper procedure when starting a machine with a new abrasive wheel mounted on it, or starting a machine after the machine and wheel have been stored for a period of time, or remounting a wheel. ANSI B7.1-2000 requires the following procedure when starting a newly mounted grinding wheel.

9.8 STARTING THE WHEEL (REQUIREMENTS)

All abrasive wheels shall be run at operating speeds with the safety guard in place or in a protected enclosure for at least one minute before applying work. During this time no one shall stand in front of or in line with the wheel. (See section 4, for safety guard requirements.) This provision shall apply each time one of the following conditions occur: a) a new wheel has been mounted; or b) a used wheel has been remounted.

E 9.8 STARTING THE WHEEL (EXPLANATORY INFORMATION)

An abrasive wheel may be damaged in shipment or storage, or the wheel may be subjected to improper, excessive stresses during mounting. Wheels which have been damaged or are under excessive stress, are likely to fracture within the first minute of rotation at operating speed. While this procedure is most important at the time when an abrasive wheel is mounted or remounted, damage may also occur to a wheel during a shut down of the machine on which it is mounted. The user should evaluate the circumstances and length of machine shut down to determine additional times that the operating rule should be followed.

Improper wheel mounting is a major cause of wheel breakages. Always use proper mounting procedures as outlined in ANSI B7.1, machine manufacturer's instructions and those supplied with the abrasive wheel. Be safe, know and follow the rules!

For additional information on this topic or any other abrasive product safety information, please review ANSI, OSHA and literature provided by the grinding wheel and machine manufacturer.

WHAT YOU SHOULD KNOW ABOUT GRINDING WHEEL GUARDS

Reports indicate customers in the grinding wheel industry break approximately one grinding wheel per day. Most of these breakages are caused by human error, do not result in personal injury, and generally go unreported. Grinding wheel guards are one of the key components in keeping these grinding wheel mishaps from becoming a personal injury.

DAINGEROUS CONDITIONS CAUSED BY THE INEFFECTIVE USE OF GRINDING WHEEL GUARDS:

Incorrect: Cup wheels such as Type 6 and 11 used on a portable angle grinder with a Type 27, 28 and 29 depressed center grinding wheel guard.

Explanation: While a properly adjusted Type 27, 28 and 29 guard works with a Type 27, 28 or 29 wheel, it offers little or no protection with a Type 6 or 11 cup wheel. The cup wheel "hangs" below the guard meant for a Type 27, 28 or 29 wheel and in the event of a wheel breakage; it offers little or no protection.

Incorrect: Type 01 straight cut-off wheels used on a portable angle grinder with a Type 27, 28 or 29 depressed center grinding wheel guard.

Explanation: Type 27, 28 and 29 guards are open on the bottom to allow for side grinding with raised hub/depressed center wheels. When side grinding with the Type 27, 28 or 29 wheel, the workpiece acts as a portion of the guard, protecting the operator in the event of a wheel breakage. Cut-off wheels are not designed for use on their side and must be used on their outer periphery only. Guards for cut-off wheels must cover a full 180° area on all sides of the wheel. When using a cut-off wheel with a Type 27, 28 or 29 guard, there is no guard on one side of the wheel, protecting the operator in the event of a wheel breakage. Do not use cut-off wheels on angle grinders without the proper guard.

In Summary: Grinding wheel guards designed for one type of machine used on another type of machine, or the wrong guards for the type of wheel, are dangerous.

INEFFECTIVE GRINDING WHEEL GUARDS:

- The most ineffective guard is the one that has been removed from its machine and is sitting in storage. The removal of a wheel guard on a machine in operation is not only extremely dangerous, but illegal.
- Do not alter or cut back a guard. Using a damaged or altered wheel guard is extremely dangerous to the safety of the operator and bystanders. Guards that are altered, cracked, deformed, bent, or severely worn must be replaced. Once a guard has been damaged, it might become ineffective in a future wheel breakage. If a wheel breakage occurs, the guard must be inspected and if there is any sign of damage, the guard must be replaced.
- Machines with missing wheel guard fasteners are also very dangerous. Sometimes during routine machine maintenance the guard fasteners are damaged and not replaced when the machine is reassembled. During a wheel breakage, the missing fasteners might allow the guard to move, become unattached from the machine or open, exposing the operator to being injured by the guard or not containing the wheel fragments in the event of a wheel break.
- A guard made of paper, tin, cloth, wood or other materials not designed to contain wheel fragments might fail when struck by a wheel fragment. Always use the guard that is recommended for the machine and its operation. Never paint or disguise the wrong material for a proper guard.

GUARDS NOT PROPERLY ADJUSTED:

- A wheel guard that is set too high on a portable angle grinder will allow the wheel to hang below the guard. This improper setting may render the guard useless in the event of a wheel breakage.
- The wheel guard of a portable machine positioned improperly. A guard used on a portable machine must be positioned so it is located between the operator and the grinding wheel. Also, bystanders must not be positioned in front of the wheel guard's open area.
- Failure to maintain the proper setting of the adjustable tongue guard (AKA spark arrester) on bench, pedestal, or small floor stand grinder. OSHA requires a maximum clearance of 1/4" between the grinding wheel and the tongue guard. If a wheel breakage should occur, maintaining the proper distance will help to contain the wheel fragments and reduce the probability of an injury.

HOW TO PERFORM A RING TEST ON A GRINDING WHEEL

One method of grinding wheel inspection is called ring testing. OSHA, ANSI and the grinding wheel manufacturers require this method of grinding wheel inspection. It must be performed BEFORE the wheel is mounted on a grinding machine. Ring testing depends on the damping characteristics of a cracked wheel to alter the sound emitted when the wheel is tapped lightly. It is subject to interpretation by the inspector and is primarily applicable to vitrified bonded wheels. To perform the ring test, wheels should be tapped gently with a light nonmetallic implement, such as the handle of a screw driver for light wheels, or a wooden mallet for heavier wheels.

- Tap wheels about 45 degrees each side of the vertical line and about 1" or 2" from the periphery. Rotate the wheel 45 degrees and repeat the test.
- Large and thick wheels may be given the ring test by striking the wheel on the periphery rather than the side of the wheel.
- A sound and undamaged wheel will give a clear tone. If cracked, there will be a dead sound and not a clear ring and the wheel should not be used.
- Wheels must be dry and free of sawdust when applying the ring test, otherwise the sound may be deadened. The ring test is not applicable to certain wheels because of their size, shape or composition.



Safety – It’s the Smart Thing to Do

SAFE OPERATING PRACTICES MUST BE PART OF EVERY GRINDING WHEEL USER’S OPERATION.

- 1 Be sure to read any safety material/guidelines provided with the abrasive product.
- 2 Always check the wheel for cracks or damage before use.
- 3 Before mounting the wheel, use a tachometer to measure the spindle speed. Wheel speeds should never exceed the maximum speed shown on the wheel or package.
- 4 Ensure the mounting flanges, backplate or adapter supplied by the machine manufacturer are properly used and kept in good condition. ANSI Safety Requirement B7.1 provides wheel mounting requirements. Check mounting flanges for equal and correct diameter and use blotters when supplied.
- 5 Always mount, true and dress the wheel in compliance with the guidelines published in the ANSI Safety Requirements B7.1.
- 6 Ensure the correct wheel guard is in place before starting the wheel. Allow the wheel to come up to full operating speed for a minimum of 1 minute before starting to grind. Stand out of the plane of rotation.
- 7 NEVER use a high speed air sander as a portable grinder.
- 8 Never use a grinding wheel with a rated speed less than the grinder.
- 9 NEVER exceed the maximum operating speed marked on the wheel being used. The following formula may be used to convert wheel speed from RPM to SFPM.
SFPM = Spindle Speed in RPM x Wheel Diameter in inches x .262
(or refer to the Wheel Speeds Conversion Table, where applicable, in Bonded Abrasives Basics)
- 10 When not using the wheel, store the wheel in its original packing materials and avoid dropping or bumping the wheel. This protects the wheel from chips and cracking, as well as provides easy identification of the wheel.

To obtain the maximum performance of the wheel, your operating procedures must include the care of the product both before and after its actual use. The greatest efficiency and lowest overall abrasive cost can be realized only if proven care and use techniques become standard practice.

SAINT-GOBAIN ABRASIVES TRADEMARKS

Abrasive Connection®	Carborundum logo®	EZ-Touch™	Gold™	PowerFlex®	Speed-Lok®
Abrasive Connection Express®	Carbo Medalist™	E-ZView™	Gold Cut™	PowerLock®	Stick-On™
Abrasotex™	Carbo Premier Red™	FastTrack™	Gold MaXX™	PowerStrip™	Surface Blend™
Carbo™	Carbo White™	Fat Boy™	Gold XT™	Premier Red™	Surface Prep™
Carbo CleanAir®	Charger™	Fibratex®	Grind-O-Flex™	Premier Red Cut™	Surface Strip™
Carbo CleanAir Plus™	Clean Bond™	FlexDrum™	Grip-On®	PremRed™	Thin-Flex™
Carbo Cool®	The Definition of Different™	FlexEdge™	High Performance™	Safety Tred™	Vortex®
Carbo Fire®	Dri-Lube®	Flex-Loc™	Merit®	Sand-O-Flex™	Zenith®
Carbo Gold™	Edger™	fX™	Mirror Finish™	ShurStik™	And others.
		Gemini®	NorZon®	Sof-Tutch™	

PRODUCT WARRANTY

WARRANTY – Carborundum warrants the products in this catalog to be free from defects in material or workmanship for a period of one year from the date of purchase. Carborundum’s sole obligation under this warranty shall be to repair or replace, at Carborundum’s option, any product which is non-conforming provided any such product failure was not caused by a subsequent modification of the product, misuse or a failure to follow any applicable instructions for the product.

EXCEPT FOR THE FOREGOING, CARBORUNDUM EXPRESSLY DISCLAIMS ALL OTHER GUARANTIES AND/OR WARRANTIES, EXPRESS OR IMPLIED, INCLUDING THE WARRANTIES OF MERCHANTABILITY AND FITNESS FOR A PARTICULAR PURPOSE.

PRODUCT QUALITY COMPLAINTS

All product quality complaints should be submitted to your local Carborundum Distributor.

LIABILITY LIMITATION

CARBORUNDUM’S LIABILITY FOR ANY LOSS OR DAMAGE ARISING OUT OF OR RESULTING FROM THE USE OF THE PRODUCT SHALL NOT EXCEED THE PURCHASE PRICE THEREOF, REGARDLESS OF WHETHER SUCH LIABILITY ARISES IN CONTRACT, TORT (INCLUDING WITHOUT LIMITATION NEGLIGENCE OR STRICT LIABILITY), OR OTHERWISE, AND IN NO EVENT SHALL CARBORUNDUM BE LIABLE FOR INDIRECT, SPECIAL, INCIDENTAL OR CONSEQUENTIAL DAMAGES OF ANY KIND. NO REPRESENTATIVE OF CARBORUNDUM, NOR ANY OF CARBORUNDUM’S DISTRIBUTORS OR DEALERS, IS AUTHORIZED TO MODIFY THIS WARRANTY OR ISSUE ANY WARRANTY REGARDING THE PRODUCTS IN THIS CATALOG.

the definition of **DIFFERENT™**

"Different" is more than a tagline. Carborundum Abrasives embodies its uniqueness in product, pricing and experience with a market approach to match. Our brand differentiation represents our rich history of commitment to developing better abrasives that offer better value leadership without compromise. Building and maintaining your business with Carborundum Abrasives just keeps getting easier. Call, click, or visit us online to learn how a different way of doing business doesn't have to be complicated.



Customer Service

Distributors: To place an order, contact our customer service support center with:

- Customer number and contact name
- Complete product information:
 - 11-digit Part Number
 - Product description
 - Quantity and unit of measure
 - Price by unit of measurement

To ensure minimal errors and faster turnaround, using electronic media is preferred. For assistance with www.abrasiveconnection.com or EDI setup, contact us at:

Email: abrasive.connection@saint-gobain.com

Phone: 888-383-2236



Judge for Yourself

Carborundum | Saint-Gobain is so confident of the superior performance of our abrasive products, as recommended for specific applications, that we invite in-plant tests against any other brand of abrasive product on the market.

The Carborundum No-Risk Test Policy

- 1 The test will be conducted in the user's own plant, on their own machines, using their own work-pieces.
- 2 Even if the user purchases only a minimum quantity of Carborundum abrasive products, the user will receive the same quantity discount as would apply to their normal production orders.
- 3 If the Carborundum product tested proves completely unsatisfactory, the user will receive a full refund.
- 4 If the Carborundum product tested performs at a lower level than the product presently in production, the user will receive an adjustment to make up the difference in performance.
- 5 The user is the final judge of performance!



Online

The printed catalog is a great starting resource for Carborundum and Merit product selection. Our website is the ideal resource for a more comprehensive outline of product and application information. It is continually updated with all our most current information and offers more electronic queries for deeper detail, at the click of a button.



*The **courage** to stand apart.
The **wisdom** to think competitively.
The **experience** to back you up.*



*Carborundum Abrasives – the definition of
DIFFERENT™*

BETTER ABRASIVES, BETTER VALUE – BETTER THAN EVER!

Count on Carborundum Abrasives to continually add the essentials of brand differentiation with our products, pricing, and experience to help you meet the evolving needs of your customers and markets.



products - the courage to stand apart with choices

A full line of leading-edge products for your toughest MRO applications. From the day-to-day products that keep your business running, to the market innovations that maximize productivity with lowest total cost.



pricing - the heart to make you profitable

A four-tier performance-to-quality ratio to best suit the unique needs of each of your customers and give you a competitive advantage. From the highest quality materials and engineering, to the lowest initial cost.



experience - the wisdom to leverage our expertise

A network of deep product knowledge and high sales support that is fully supported by a responsive customer service team to best service the distribution framework that keeps your business moving forward.



CARBORUNDUM

U.S.A. CUSTOMER SERVICE:
Phone Toll Free: 1 (800) 231-4154
Fax Toll Free: 1 (800) 4589-3448
Local Phone: 1 (254) 918-2304
Local Fax: 1 (254) 918-2305

CANADA CUSTOMER SERVICE:
Phone Toll Free: 1 (800) 268-2262
Fax Toll Free: 1 (800) 561-9490



**GUARANTEED
NO RISK
TEST POLICY**

FORM #CA1000 REV 01/15

© 2015 Saint-Gobain.

The Carborundum logo is a registered trademark of Saint-Gobain.

SAINT-GOBAIN